

2208e 2204e

MODELS



Programmer/Controllers

Product data

Features

- Heating and cooling with two modular outputs
- Motorised Valve output
- Customised operation
- Heater current display
- Load diagnostics
- Up to three alarm relays
- 10amp output (2204e only)
- Self-tuning with overshoot inhibition
- Optimised fan, water and oil cooling
- Setpoint rate limit with timer function
- Digital communications
- Plug-in from front
- IP65 panel sealing
- Compliant with European EMC and low voltage safety directives
- 3 Year warranty

The 2204e/2208e is a versatile, high stability temperature or process controller, with self tuning, in 1/4 DIN and 1/8 DIN sizes. It has a modular hardware construction with the option of two control outputs, two alarm relays and a communications module. Two Digital inputs are included as standard. The hardware is configurable for heating, cooling or alarms. The 2204e/2208e is fully configurable on-site.

Precise control

An advanced PID control algorithm gives stable 'Straight-line' control of the process. A one-shot tuner is provided to set up the initial PID values and to calculate the overshoot inhibition parameters. On electrically heated loads, power feedback is used to stabilise the output power and hence the controlled temperature against supply voltage fluctuations. Dedicated cooling algorithms ensure optimum control of fan, water and oil cooled systems.

Universal input

A universal input circuit with an advanced analogue to digital convertor samples the input at 9Hz and continuously corrects it for drift. This gives high stability and rapid response to process changes. High noise immunity is achieved by rejection of 50/60Hz pick-up and other sources of noise. Sensor diagnostics are also provided. The input will accept all standard thermocouples, the Pt100 resistance thermometer and linear millivolts, milliamps or DC volts.

Input filtering from OFF to 999.9 seconds is included.

Customised operation

A custom LED display provides a bright, clear display of the process value and setpoint. Tactile push buttons ensure positive operation. Access to other parameters is simple and easy to understand and can be customised to present only those parameters that need to be viewed or adjusted. All other parameters are locked away under password protection.

Alarms

Up to four process alarms can be combined onto a single output. They can be full scale high or low, deviation from setpoint, rate of change or load failure alarms. Alarm messages are flashed on the main display. Alarms can be configured as latching or non-latching and also as 'blocking' type alarms which means that they will become active only after they have first entered a safe state.

Digital communications

Available with either EIA485 2 wire, EIA422 4 wire or EIA232. With industry-standard protocols including: Modbus®, Eurotherm Bisync, DeviceNet®.

PDSIO Load diagnostic

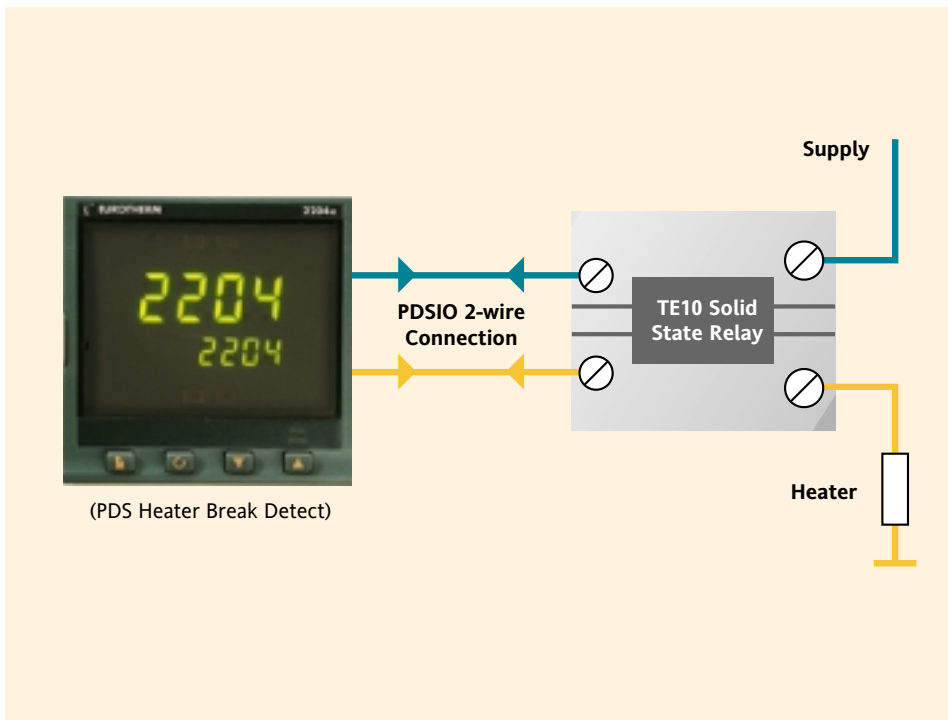

PDSIO Load diagnostics

PDSIO (Pulse Density Signalling I/O) is a major innovation in the 2204e/2208e. When used in combination with a Eurotherm TE10 solid state relay (SSR), it allows the logic output of a 2204e/2208e to transmit the power demand signal and simultaneously read back load fault alarms. These alarms will be flashed as messages on the controller front panel.

Two alarm conditions will be detected, either SSR failure indicating an open or short circuit condition in the SSR and heater circuit failure indicating either fuse failure, heater open circuit or line supply absent.

PDSIO mode 2 will monitor load current and display value, giving an alarm if current is out of limits.

PDSIO Setpoint transmission

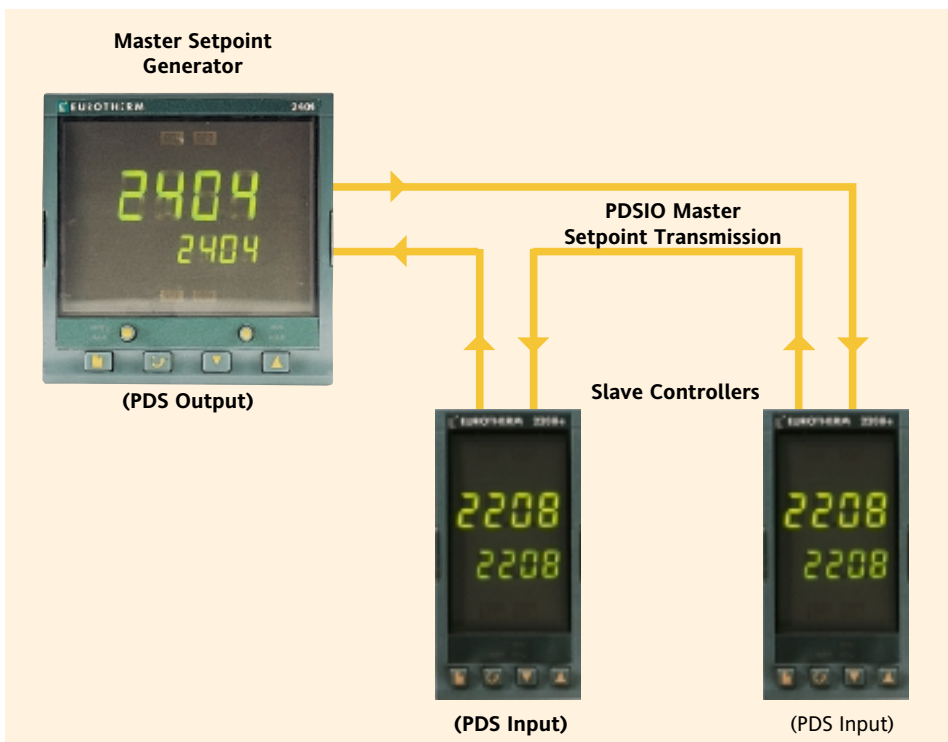

PDSIO setpoint input

PDSIO can be used to digitally transmit the setpoint profile from a 2404/08 to a number of slave Series 2200e or 2400 controllers. If any slave zone departs from the required setpoint by more than a pre-settable amount, a signal from any slave can be transmitted back to the master causing the program to freeze until the error is corrected. Digital accuracy is preserved using PDSIO.

Technical specification

Inputs

General	Range	-10mV to 80mV and 0 to 10Vdc (auto ranging)
	Sample rate	9Hz (110mS)
	Calibration accuracy	0.25% of reading, $\pm 1^{\circ}\text{C}$ or ± 1 LSD or whichever is the greater
	Resolution	$<1\mu\text{V}$ for $\pm 100\text{mV}$ range, $<0.2\text{mV}$ for 10Vdc range
	Linearisation accuracy	$<0.1\%$ of reading
	Input filter	OFF to 999.9secs
	Zero offset	User adjustable over the full display range
Thermocouple	Types	See sensor inputs table (ordering information)
	Cold junction compensation	Automatic compensation typically >30 to 1 rejection of ambient temperature change External references 0, 45 and 50°C
RTD/PT100	Type	3-wire, Pt100 DIN43760
	Bulb current	0.2mA
	Lead compensation	No error for up to 22 ohms in all 3 leads
Process	Range	-10 to 80mV, 0 to 20mA or 0 to 10Vdc (All configurable between limits)
	Type	Linear
	Application	Process value
Digital	Type	Contact closure
	Application	Manual select, 2nd setpoint, remote setpoint select, internal hold, acknowledge alarms, lock keypad, reset, load current, standby

Outputs

Relay	Rating: 2-pin relay	Min: 12V, 100mA dc. Max: 2A, 264Vac resistive
	Rating: change-over, alarm relays	Min: 6V, 1mA dc. Max: 2A, 264Vac resistive
	Application	Heating, cooling or alarms
Logic	Rating	18Vdc at 24mA (non-isolated)
	Application	Heating, cooling or alarms PDSIO mode 1: Logic heating with load failure alarm PDSIO mode 2: Logic heating with load/SSR failure alarm and load current display PDSIO mode 5: For use with external SSR and contactors not fitted with PDSIO input
	Rating	1A, 30 to 264Vac resistive
	Application	Heating or cooling
High Current (2204e only)	Rating	10A, 264Vac resistive
	Application	Heating/cooling
Analogue	Range	Isolated, 0 to 20mA @ 12V (configurable between limits). 600 Ω max load resistance
	Application	Heating or cooling
Retransmission		Process value, setpoint or error, mA or volts with external burden resistor

Communications

Digital	Transmission standard	EIA232, EIA422, EIA485 at 1200, 2400, 4800, 9600 and 19,200 baud
	Protocols	Modbus® or Eurotherm Bisych or DeviceNet®
PDSIO	Setpoint input	Setpoint input from master PDSIO controller. Holdback to master controller

Control functions

Control	Modes	PID or PI with overshoot inhibition, PD, P only or On/Off
	Application	Heating and cooling or process output
	Auto/manual	Bumpless transfer
	Setpoint rate limit	OFF to 999.9 degrees or display units per minute
	Cooling algorithms	Linear; Water (non-linear); Fan (minimum on time). Oil (Proportional only)
Tuning	One-shot tune	Automatic calculation of PID and overshoot inhibition parameters
	Automatic droop compensation	Automatic calculation of manual reset value when using PD control
Alarms	Types	Full scale high or low. Deviation high, low, or band. High current, low current
	Modes	Latching or non-latching. Normal or blocking action Up to four process alarms can be combined onto a single output

General

Display	Dual, 4 digit x 7 segment high intensity LED
Dimensions & weight	2204e - 96W x 96H x 103D mm. 600g
	2208e - 48W x 96H x 103D mm. 400g
Supply	85 to 264Vac -15%, +10%. 48 to 62Hz. 10watts max
Temperature and RH	Operating: 0 to 55°C, RH: 5 to 90% non-condensing. Storage: -10 to 70°C
Panel sealing	IP65
Electromagnetic compatibility	Meets generic emissions standard EN50081-2 for industrial environments
	Meets general immunity requirements of EN50082-2(95) for industrial environments
Safety standards	EN61010, installation category 2. (voltage transients must not exceed 2.5kV)
Atmospheres	Electrically conductive pollution must be excluded from the cabinet in which this controller is mounted. This product is not suitable for use above 2000m or in corrosive or explosive atmospheres without further protection.

Dimensional details

All dimensions in mm

2208e

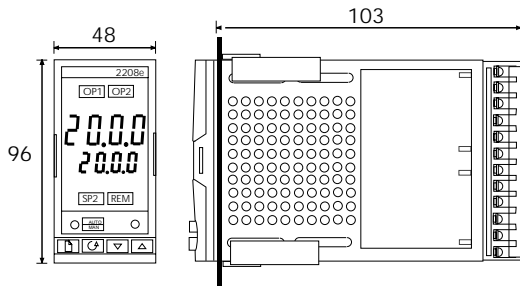

Panel cut-out	
92	-0.0 +0.8
x	-0.0
45	+0.6

2204e

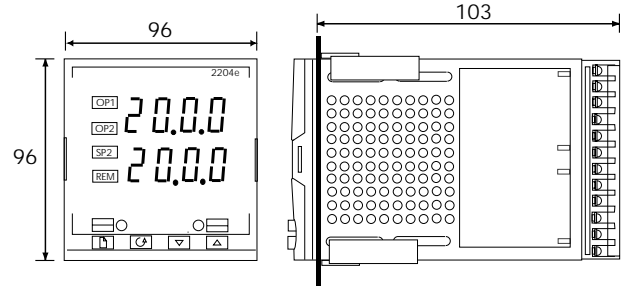

Panel cut-out	
92 x 92	-0.0 +0.8

Ordering information

Hardware coding

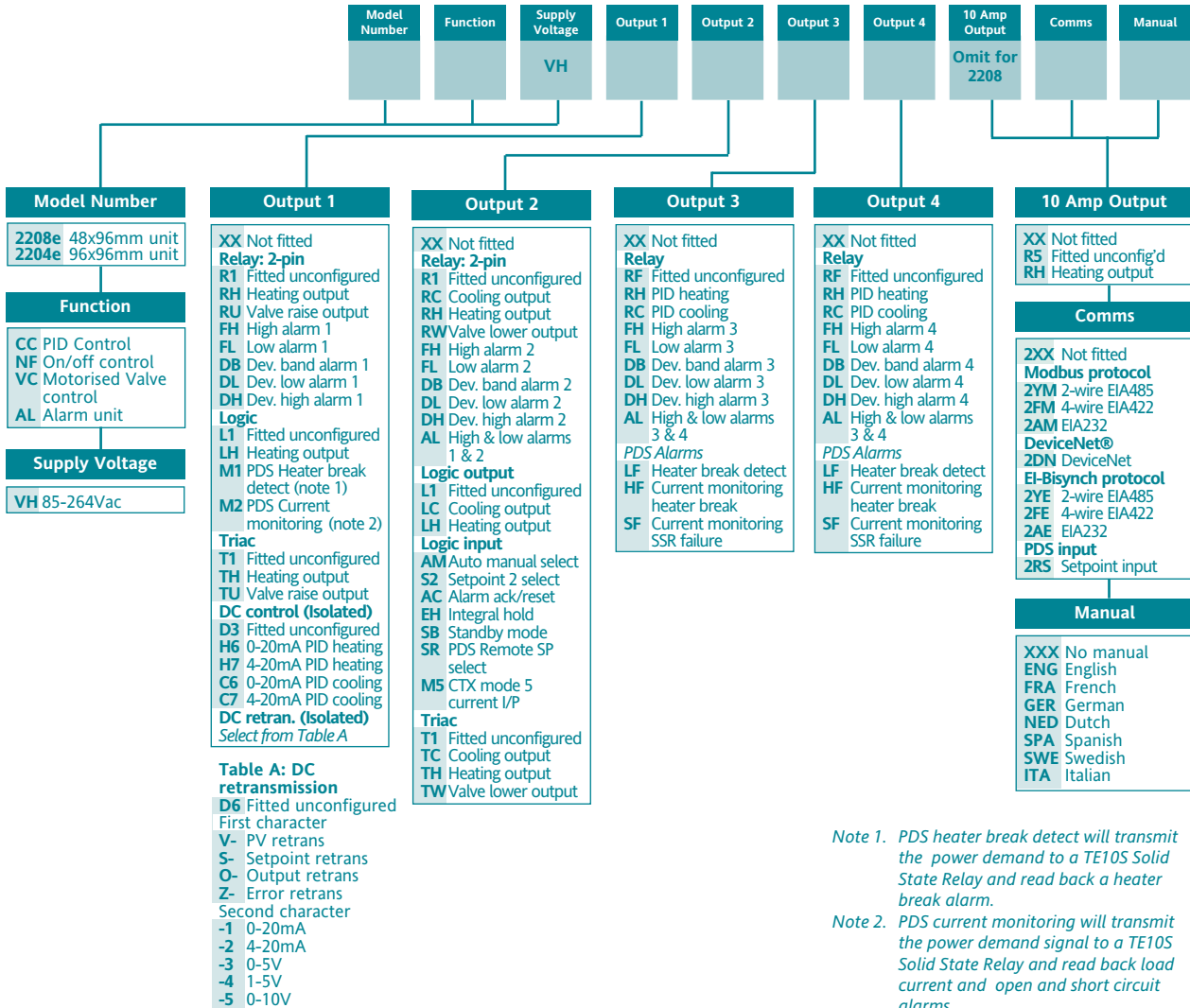

Note 1. PDS heater break detect will transmit the power demand to a TE10S Solid State Relay and read back a heater break alarm.

Note 2. PDS current monitoring will transmit the power demand signal to a TE10S Solid State Relay and read back load current and open and short circuit alarms.

Configuration coding (optional)

Sensor input	Setpoint Min	Setpoint Max	Display Units	Digital Input 1	Digital Input 2	Control	Options Power	Cooling
	note 3	note 3						
Sensor Input			Setpoint Min	Setpoint Max	Display Units		Options	
Standard Sensor Inputs			Min	Max	Display Units		Options	
J	J Thermocouple	-210	1200	C	Celsius	XX	Reverse acting (std)	
K	K Thermocouple	-200	1372	F	Fahrenheit	DP	Direct acting	
T	T Thermocouple	-200	400	K	Kelvin	Power feedback		
L	L Thermocouple	-200	900	XX	Linear input	XX	Enabled on logic, relay & triac heating outputs	
N	N Thermocouple-Nicrosil/Nisil	-200	1300			PD	Feedback disabled	
R	R Thermocouple-Pt/Pt13%Rh	-50	1700			Cooling options		
S	S Thermocouple-Pt /Pt10%Rh	-50	1768			XX	Linear cooling	
B	B Thermocouple-Pt/Pt30%Rh -6%Rh	0	1820			CF	Fan cooling	
P	Platinel II Thermocouple	0	1369			CW	Water cooling	
Z	RTD/PT100 DIN 43760	-200	850					
Factory Downloaded Input			Min	Max	Digital Input 1 & 2		Options	
C	C Thermocouple - W5%Re/W26%Re (Hoskins)	0	2319	XX	No function			
D	D Thermocouple - W3%Re/W25%Re	0	2399	AM	Manual select			
E	E Thermocouple	-250	1000	SR	PDS Remote setpoint select			
1	Ni/Ni18%Mo Thermocouple	0	1399	S2	Second setpoint			
2	Pt20%Rh/Pt40%Rh Thermocouple	0	1870	EH	Integral hold			
3	W/W26%Re (Englehard) Thermocouple	0	2000	AC	Alarm acknowledge			
4	W/W26%Re (Hoskins) Thermocouple	0	2010	SB	Standby mode			
5	W5%Re/W26%Re (Englehard) Thermocouple	10	2300	M5	CTX mode 5 current input (input 1 only)			
6	W5%Re/W26%Re (Bucose) Thermocouple	0	2000					
7	Pt10%Rh/Pt40%Rh Thermocouple	200	1800					
8	Exergen K80 I.R. pyrometer	-45	650					
Process Inputs (Scaled to setpoint min and max)			Min	Max				
M	-9.99 to 80.00mV linear	-999	9999					
Y	0 to 20mA linear (note 4)	-999	9999					
A	4 to 20mA linear (note 4)	-999	9999					
W	0 to 5Vdc linear	-999	9999					
G	1 to 5Vdc linear	-999	9999					
V	0 to 10Vdc linear	-999	9999					

Note 3. Setpoint limits: Include the decimal position required in the displayed value. Up to one for temperature inputs, up to two for process inputs.

Note 4. An external 1% current sense resistor is supplied as standard. If greater accuracy is required, a 0.1% 2.49Ω can be ordered as part no. SUB2K/249R.1.

Example ordering code:

2208e - CC - VH - LH - TC - FL - FH - 2YM - ENG - K - 0 - 1000 - C - XX - XX - XX - XX - XX

2208e, Controller, 85 to 264Vac, Logic heating, Triac cooling, Low alarm relay, High alarm relay, EIA485, Modbus comms, English manual, type K thermocouple, 0 to 1000°C, Digital input 1 no function, Digital input 2 no function, reverse acting, power feedback enabled, linear cooling

Rear terminal connections

Outputs 1 and 2 are optional outputs which can be any one of the types shown in the tables below. They can be configured for heating, cooling or alarms.

Output 1	Relay	Logic Output	Triac	DC Output
1A		+ 1B		+ -
Output 2	Relay	Logic Output	Triac	
2A		+		
2B		-		

2208e

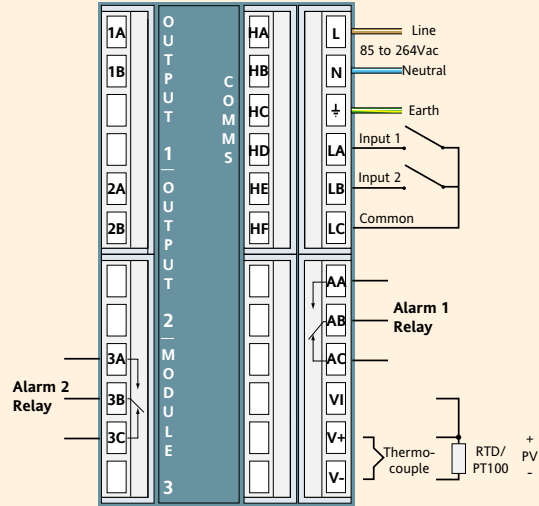

Outputs 1 and 2 are optional outputs which can be any one of the types shown in the tables below. They can be configured for heating, cooling or alarms.

Output 1	Relay	Logic Output	Triac	DC Output
1A		+ 1B		+ -
Output 2	Relay	Logic Output	Triac	
2A		+		
2B		-		

2204e

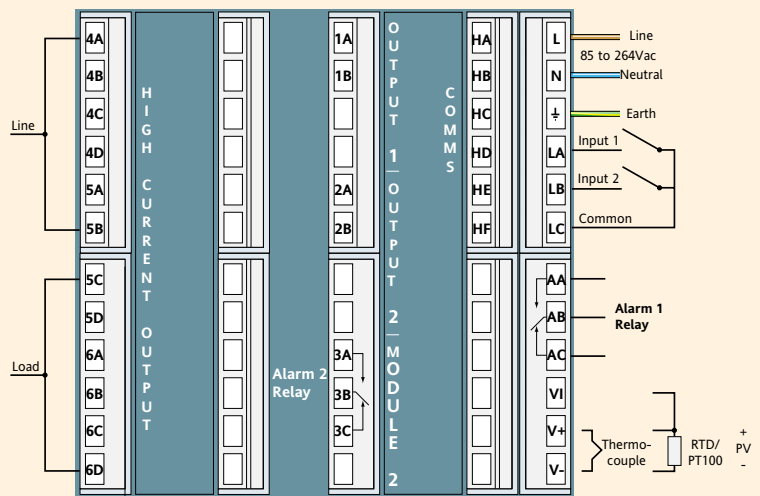

EUROTHERM LIMITED UK

Faraday Close Durrington Worthing BN13 3PL
Tel. +44 (0)1903 268500 Fax +44 (0)1903 695666
Email info@eurotherm.co.uk
www.eurotherm.co.uk

EUROTHERM US

741-F Miller Drive Leesburg VA 20175-8993
Tel. 1-703-443-0000 Fax 1-703-669-1300
Email info@eurotherm.com
www.eurotherm.com

EUROTHERM WORLDWIDE

www.eurotherm.co.uk

© Copyright Eurotherm Controls Limited 1999

All rights strictly reserved. No part of this document may be stored in a retrieval system, or any form or by any means without prior written permission from Eurotherm Controls Limited. Every effort has been taken to ensure the accuracy of this specification. However in order to maintain our technological lead we are continuously improving our products which could, without notice, result in amendments or omissions to this specification. We cannot accept responsibility for damage, injury loss or expenses resulting therefrom.

Part No. HA025552 Issue 3.2

2208e/2204e Data sheet

Printed in England 08.04

