

SIEMENS

SIMATIC HMI

HMI device
TP 270, OP 270, MP 270B
(WinCC flexible)

Operating Instructions

Preface

Overview

1

Safety notes and general
information

2

Plan deployment

3

Installation and connection

4

Operating elements and
indicators

5

Operating system and
configuration

6

Prepare and backup project

7

Runtime functionalities of a
project

8

Operate project

9

Operating recipes

10

Maintenance/Service

11

Technical data

12

Appendix

A

Abbreviations

B

Glossary

C

Order number 6AV6691-1DD01-0AB0

Edition 03/2004

A5E00280664-01

Safety Guidelines

This manual contains notices which you should observe to ensure your own personal safety as well as to avoid property damage. The notices referring to your personal safety are highlighted in the manual by a safety alert symbol, notices referring to property damage only have no safety alert symbol.



Danger

indicates an imminently hazardous situation which, if not avoided, will result in death or serious injury.



Warning

indicates a potentially hazardous situation which, if not avoided, could result in death or serious injury.



Caution

used with the safety alert symbol indicates a potentially hazardous situation which, if not avoided, may result in minor or moderate injury.

Caution

used without safety alert symbol indicates a potentially hazardous situation which, if not avoided, may result in property damage.

Notice

used without the safety alert symbol indicates a potential situation which, if not avoided, may result in an undesirable result or state.

When several danger levels apply, the notices of the highest level (lower number) are always displayed. If a notice refers to personal damages with the safety alert symbol, then another notice may be added warning of property damage.

Qualified Personnel

The device/system may only be set up and operated in conjunction with this documentation. Only qualified personnel should be allowed to install and work on the equipment. Qualified persons are defined as persons who are authorized to commission, to earth, and to tag circuits, equipment and systems in accordance with established safety practices and standards.

Intended Use

Please note the following:



Warning

This device and its components may only be used for the applications described in the catalog or technical description, and only in connection with devices or components from other manufacturers approved or recommended by Siemens.

This product can only function correctly and safely if it is transported, stored, set up and installed correctly, and operated and maintained as recommended.

Trademarks

All designations marked with ® are registered trademarks of Siemens AG. Other designations in this documentation might be trademarks which, if used by third parties for their purposes, might infringe upon the rights of the proprietors.

(A)

가

Copyright Siemens AG, 2004. All rights reserved

Reproduction, transmission or use of this document or its contents is not permitted without express written authority. Offenders will be liable for damages. All rights, including rights created by patent grant or registration of a utility model or design, are reserved.

Disclaimer of Liability

We have checked the contents of this manual for agreement with the hardware and software described. Since deviations cannot be precluded entirely, we cannot guarantee full agreement. However, the data in the manual are reviewed regularly, and any necessary corrections will be included in subsequent editions. Suggestions for improvement are welcomed.

Siemens AG
Automation and Drives Group
P.O. Box 4848, D-90327 Nuremberg (Germany)

© Siemens AG 2004
Technical data subject to change

Preface

Purpose of the manual

This manual provides the required information and documentation for machine construction in compliance with DIN 8418. The information contained relates to the device, its installation site, transport, storage, use and maintenance.

The manual is aimed at the following target groups:

- Users
- Commissioners
- Service technicians
- Maintenance engineers

Read carefully the Chapter "Safety and General Information".

The help integrated in WinCC flexible, namely the WinCC flexible Information System, contains further information. The Information System provides instructions, examples and references in electronic form.

Basic knowledge required

A general knowledge of automation technology and process communication is necessary in order to understand the manual.

It is assumed users have good basic knowledge in the use of personal computers and MS Windows operating systems.

Manual application

The manual applies to the SIMATIC MP 270B, OP 270 and TP 270 in connection with the WinCC flexible 2004 software packet.

Modifications compared to previous release 12/2001

The manual describes the use of the HMI devices together with WinCC flexible 2004. For implementation with WinCC flexible 2004, the MP 270B 6" device model is also available.

The previous version, 12/2001, can still be used on the HMI device with ProTool.

Position in the information scheme

This manual is part of the SIMATIC HMI documentation. The information below presents an overview of the information scheme of SIMATIC HMI.

User manual

- WinCC flexible Micro:
 - Describes basic configuration principles using the WinCC flexible Micro Engineering System
- WinCC flexible Compact/Standard/Advanced:
 - Describes basic configuration principles using the WinCC flexible Compact Engineering System/WinCC flexible Standard/WinCC flexible Advanced
- WinCC flexible Runtime:
 - Describes commissioning and operating the runtime project on a PC.
- WinCC flexible Migration:
 - Describes how to convert an existing ProTool project to WinCC flexible.
 - Describes how to convert an existing WinCC project to WinCC flexible.
 - Describes the conversion of ProTool projects together with changing the HMI device from OP7 to OP 77B.
 - Describes the conversion of ProTool projects together with changing the graphic HMI devices to Windows CE devices.
- Communication
 - Communication Part 1 describes the connection of the HMI device to SIMATIC PLCs.
 - Communication Part 2 describes the connection of the HMI device to third-party PLCs.

Operating instructions

- Operating instructions for HMI devices SIMATIC OP 77B, TP 170micro/TP 170A/TP 170B/OP 170B, SIMATIC Mobile Panel 170, SIMATIC TP 270/OP 270/MP 270B, SIMATIC MP 370.
- Quick reference manuals for the SIMATIC OP 77B and SIMATIC Mobile Panel 170 HMI devices.

Getting started

- WinCC flexible for beginners:
 - Provides step-by-step instructions on the principles of configuring screens, alarms, recipes and screen navigation using an project example.
- WinCC flexible for advanced users:
 - Provides step-by-step instructions on the principles of configuring logs, project reports, scripts, user administration, multilingual projects and integration in STEP 7 using an project example.
- WinCC flexible Options:
 - Provides step-by-step instructions on the principles of configuring the options WinCC flexible Sm@rtServices, Sm@rtAccess and OPC-Server using an project example.

Online availability

The following links provide direct access to technical documentation on SIMATIC products and systems in English, German, French, Italian and Spanish:

- SIMATIC Guide Technical Documentation in German:
http://www.ad.siemens.de/simatic/portal/html_00/techdoku.htm
- SIMATIC Guide for Technical Documentation in English:
http://www.ad.siemens.de/simatic/portal/html_76/techdoku.htm

Conventions

A distinction has been made in the naming of the configuration and runtime software:

- "WinCC flexible" refers to the configuration software.
- "Runtime" refers to the runtime software capable of running on the HMI devices.

Generally, the term "WinCC flexible" is used. The version identification, e.g. "WinCC flexible 2004", is always used when it is necessary to make a version distinction.

The following text highlights are intended to simplify reading the manual:

Display method	Application
"Add screens"	<ul style="list-style-type: none"> • Terms which appear on the user interface, e.g. dialog names, tabs, buttons, menu commands. • Required input, e.g. limit values, tag values. • Path information
"File > Edit"	Operation sequences, e.g. menu commands, pop-up menu commands.
<F1>, <Alt+P>	Keyboard input

Also observe the information identified as follows:

Note

Notes contain important information about the product or operation of the product. Notes also refer to areas within the documentation which require special attention.

Trademarks

All names identified by ® are registered trademarks of the Siemens AG.

HMI®
SIMATIC®
SIMATIC HMI®
SIMATIC ProTool®
SIMATIC WinCC®
SIMATIC WinCC flexible®
SIMATIC MP 270B®
SIMATIC OP 270®
SIMATIC TP 270®

The remaining trademarks in this publication may be trademarks whose use by third parties for their own purposes could violate the rights of the owner.

Representatives and agents

If you have any further queries regarding products described in the manual, please contact the Siemens representatives or agents responsible for your area.

Contact partners can be located under:

<http://www.siemens.com/automation/partner>

Training center

We offer relevant courses to simplify your introduction to the world of automation systems. Please contact your regional training center or our central training center in D 90327 Nuernberg, Germany for details.

Phone: +49 (911) 895-3200.

Internet: <http://www.sitrain.com>

Service & Support on the Internet

Service & Support provides comprehensive, additional information on SIMATIC products through online services at "<http://www.siemens.com/automation/service&support>":

- The Newsletter, containing the latest information on your products.
- Numerous documents are available by searching through Service & Support.
- A forum, in which users and specialists can exchange experiences.
- The latest product information, FAQs and downloads.
- Contact partners for Automation & Drives are listed in the contact partner database.
- Information on on-site services, repairs, spare parts and much more under the term "Services".

A&D Technical Support

Available round the clock, worldwide:

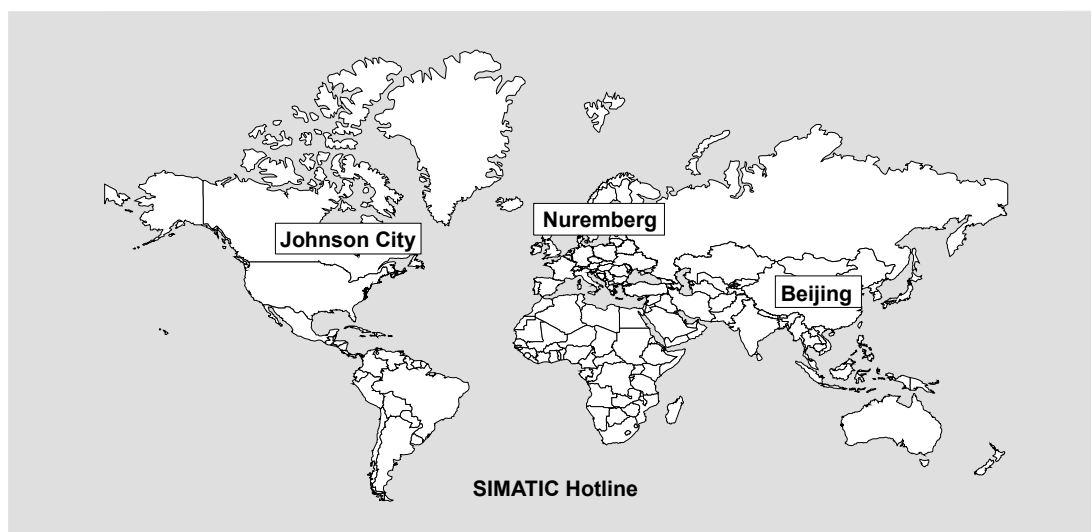

<p>Worldwide (Nuremberg) Technical Support (Free Contact)</p> <p>Local time: Mon.-Fri. 7:00 to 17:00. Phone: +49 (0) 180 5050-222 Fax: +49 (0) 180 5050-223 E-mail: adsupport@siemens.com GMT: +1:00</p>	<p>Worldwide (Nuremberg) Technical Support (fee-based, only with SIMATIC Card)</p> <p>Local time: 0:00 to 24:00, 365 days a year Phone: +49 (911) 895-7777 Fax: +49 (911) 895-7001 GMT: +1:00</p>	
<p>Europe/Africa (Nuremberg) Authorization</p> <p>Local time: Mon.-Fri. 7:00 to 17:00. Phone: +49 (911) 895-7200 Fax: +49 (911) 895-7201 E-mail: adauthorisierung@siemens.com GMT: +1:00</p>	<p>United States (Johnson City) Technical Support and Authorization</p> <p>Local time: Mon.-Fri. 8:00 to 19:00. Phone: +1 423 461-2522 Fax: +1 423 461-2289 E-mail: simatic.hotline@sea.siemens.com GMT: -5:00</p>	<p>Asia/Australia (Beijing) Technical Support and Authorization</p> <p>Local time: Mon.-Fri. 08:30 to 5:30 pm. Phone: +86 10 64 75 75 75 Fax: +86 10 64 74 74 74 E-mail: adsupport.asia@siemens.com GMT: +8:00</p>

Information is available in English and German.

Table of contents

	Preface	i
1	Overview.....	1-1
1.1	Introduction	1-1
1.2	Field of Application.....	1-2
1.3	Configuring with WinCC flexible.....	1-3
1.4	Features	1-4
1.5	Functional scope	1-7
1.6	Communication with PLCs.....	1-11
1.7	Options.....	1-12
1.7.1	Hardware options.....	1-12
1.7.1.1	Backup battery	1-12
1.7.1.2	PC card / CF card	1-14
1.7.2	Software options	1-16
1.7.2.1	Internet Explorer	1-16
2	Safety notes and general information	2-1
2.1	Safety notes	2-1
2.2	General information	2-1
3	Plan deployment.....	3-1
3.1	Transport.....	3-1
3.2	Installation notes	3-2
3.3	Installation locations and type of protection.....	3-3
3.4	Producing the installation cut-out.....	3-4
4	Installation and connection	4-1
4.1	Check shipment	4-1
4.2	Installation of the HMI device.....	4-1
4.2.1	Installing the MP 270B Keys or OP 270	4-1
4.2.2	Installing the MP 270B Touch or TP 270 10".....	4-3
4.3	Connecting the HMI device.....	4-5
4.3.1	Conditions	4-5
4.3.2	Interfaces	4-6
4.3.3	Connecting the potential equalization.....	4-8
4.3.4	Connecting peripheral equipment.....	4-10
4.3.4.1	Connect printer.....	4-10
4.3.4.2	Connect external keyboard and mouse.....	4-12
4.3.5	Connecting the PLC.....	4-13
4.3.6	Connecting the configuration computer.....	4-15
4.3.7	Connecting an uninterruptible power supply (UPS).....	4-16

4.3.8	Connecting the power supply.....	4-17
4.4	Switch on and test the HMI device.....	4-18
5	Operating elements and indicators	5-1
5.1	MP 270B Touch and TP 270.....	5-1
5.2	MP 270B Keys and OP 270	5-2
5.2.1	Key pads	5-2
5.2.2	Function keys	5-5
5.2.3	System keys.....	5-6
5.2.4	Labeling the softkeys	5-8
5.3	Operation with external keyboard/mouse	5-12
6	Operating system and configuration	6-1
6.1	HMI device loader	6-1
6.2	Windows CE Control Panel.....	6-2
6.2.1	Open Control Panel.....	6-2
6.2.2	Communication	6-5
6.2.3	Date/time	6-5
6.2.4	InputPanel	6-6
6.2.5	Network	6-6
6.2.6	OP	6-7
6.2.7	Printer.....	6-11
6.2.8	Regional Settings.....	6-13
6.2.9	Screensaver.....	6-14
6.2.10	System	6-15
6.2.11	UPS.....	6-16
6.2.12	Volume & Sounds	6-17
6.3	Network operation	6-18
6.3.1	Basic principles	6-18
6.3.2	Configuring the HMI device for network operation.....	6-19
6.3.3	Test network.....	6-21
6.3.4	Configuring network access.....	6-22
7	Prepare and backup project.....	7-1
7.1	Transfer project to the HMI device.....	7-1
7.1.1	Commissioning for the first time.....	7-1
7.1.2	Recommissioning.....	7-3
7.2	Transfer.....	7-3
7.2.1	Start transfer manually	7-3
7.2.2	Start transfer automatically	7-4
7.2.3	Transfer mode options	7-5
7.2.4	Test project	7-8
7.2.5	Uploading project	7-10
7.3	System settings.....	7-12
7.3.1	Set language	7-12
7.3.2	Set operating mode.....	7-13
7.4	Other transfer functions.....	7-14
7.4.1	Functions.....	7-14
7.4.2	Backup and Restore.....	7-15
7.4.3	Update operating system	7-18
7.4.4	Transferring authorizations	7-21
7.4.5	Transferring options	7-22

8	Runtime functionalities of a project	8-1
8.1	Screen objects	8-1
8.2	Alarms	8-2
8.3	Tags	8-3
8.4	Logs	8-3
8.5	Reports.....	8-5
8.6	System functions and scripts	8-6
8.7	Safety	8-7
8.8	Other operating functions.....	8-9
9	Operate project.....	9-1
9.1	Basic principles of operation	9-1
9.1.1	Basics for operation in runtime	9-1
9.1.2	Operating the touch panel.....	9-3
9.1.2.1	Operating touch objects	9-3
9.1.2.2	Input of values.....	9-5
9.1.2.3	Input of numeric values.....	9-5
9.1.2.4	Input of alphanumeric values	9-8
9.1.2.5	Calling the operator note.....	9-10
9.1.3	Operating a keyboard device	9-11
9.1.3.1	Functions of the system keys.....	9-11
9.1.3.2	Functions of the key combinations.....	9-12
9.1.3.3	Input of values.....	9-15
9.1.3.4	Calling the operator note.....	9-15
9.2	Controlling graphic objects.....	9-16
9.2.1	Button.....	9-16
9.2.1.1	Description	9-16
9.2.1.2	Touch control	9-17
9.2.1.3	Keyboard control.....	9-17
9.2.1.4	Mouse and keyboard control.....	9-18
9.2.2	Switch.....	9-18
9.2.2.1	Description	9-18
9.2.2.2	Touch control	9-19
9.2.2.3	Keyboard control.....	9-19
9.2.2.4	Mouse and keyboard control.....	9-19
9.2.3	I/O field.....	9-20
9.2.3.1	Description	9-20
9.2.3.2	Touch control	9-20
9.2.3.3	Keyboard control.....	9-21
9.2.3.4	Mouse and keyboard control.....	9-21
9.2.4	Graphic I/O field	9-22
9.2.4.1	Description	9-22
9.2.4.2	Touch control	9-22
9.2.4.3	Keyboard control.....	9-23
9.2.4.4	Mouse and keyboard control.....	9-23
9.2.5	Symbolic I/O field	9-24
9.2.5.1	Description	9-24
9.2.5.2	Touch control	9-24
9.2.5.3	Keyboard control.....	9-25
9.2.5.4	Mouse and keyboard control.....	9-25
9.2.6	Alarm indicator	9-26
9.2.6.1	Description	9-26

9.2.6.2	Touch control	9-26
9.2.6.3	Mouse control.....	9-27
9.2.7	Alarm view.....	9-27
9.2.7.1	Description	9-27
9.2.7.2	Touch control	9-28
9.2.7.3	Keyboard control.....	9-29
9.2.7.4	Mouse and keyboard control.....	9-29
9.2.8	Simple alarm view	9-30
9.2.8.1	Description	9-30
9.2.8.2	Touch control	9-31
9.2.8.3	Keyboard control.....	9-31
9.2.8.4	Mouse and keyboard control.....	9-31
9.2.9	Recipe view.....	9-32
9.2.9.1	Description	9-32
9.2.9.2	Touch control	9-33
9.2.9.3	Keyboard control.....	9-33
9.2.9.4	Mouse and keyboard control.....	9-34
9.2.10	Simple recipe view	9-35
9.2.10.1	Description	9-35
9.2.10.2	Touch control	9-36
9.2.10.3	Keyboard control.....	9-36
9.2.10.4	Mouse and keyboard control.....	9-37
9.2.11	Bar.....	9-38
9.2.12	Trend view.....	9-39
9.2.12.1	Description	9-39
9.2.12.2	Touch control	9-40
9.2.12.3	Keyboard control.....	9-41
9.2.12.4	Mouse and keyboard control.....	9-41
9.2.13	Slider control	9-42
9.2.13.1	Description	9-42
9.2.13.2	Touch control	9-43
9.2.13.3	Keyboard control.....	9-43
9.2.13.4	Mouse and keyboard control.....	9-44
9.2.14	Gauge.....	9-44
9.2.15	Date/time field	9-45
9.2.15.1	Description	9-45
9.2.15.2	Touch control	9-45
9.2.15.3	Keyboard control.....	9-46
9.2.15.4	Mouse and keyboard control.....	9-46
9.2.16	Clock	9-47
9.2.17	User view	9-48
9.2.17.1	Description	9-48
9.2.17.2	Touch control	9-49
9.2.17.3	Keyboard control.....	9-49
9.2.17.4	Mouse and keyboard control.....	9-49
9.2.18	Simple user view	9-50
9.2.18.1	Description	9-50
9.2.18.2	Touch control	9-50
9.2.18.3	Keyboard control.....	9-50
9.2.18.4	Mouse and keyboard control.....	9-51
9.2.19	Status/Force.....	9-52
9.2.19.1	Description	9-52
9.2.19.2	Touch control	9-53
9.2.19.3	Keyboard control.....	9-53
9.2.19.4	Mouse and keyboard control.....	9-54
9.2.20	Sm@rtClient view.....	9-55
9.2.20.1	Description	9-55

9.2.20.2	Touch control	9-57
9.2.20.3	Keyboard control	9-57
9.2.20.4	Mouse and keyboard control.....	9-58
9.2.21	Symbol library	9-58
9.2.21.1	Description	9-58
9.2.21.2	Touch control	9-59
9.2.21.3	Mouse control.....	9-59
10	Operating recipes	10-1
10.1	Recipes	10-1
10.2	Structure of recipes.....	10-3
10.3	Structure of recipe data records.....	10-4
10.4	Recipe application.....	10-5
10.4.1	Transfer of recipe data records.....	10-5
10.4.2	Configuration of recipes	10-6
10.4.3	Scenario: Entering recipe data records in Runtime	10-8
10.4.4	Scenario: Manual production sequence	10-10
10.4.5	Scenario: Automatic production sequence	10-12
10.5	Displaying recipes.....	10-13
10.5.1	Viewing and editing recipes in Runtime.....	10-13
10.5.2	Behavior of the recipe view in Runtime	10-15
10.6	Recipe data record administration	10-15
10.6.1	Recipe data record administration	10-15
10.6.2	Synchronizing a recipe data record	10-17
10.6.3	Read recipe data record from PLC	10-18
10.6.4	Transfer recipe record to PLC.....	10-18
10.6.5	Exporting and importing recipe data records	10-19
10.6.6	Reactions to modifications of the recipe structure	10-20
10.7	Example	10-21
10.7.1	Example: Creating a recipe.....	10-21
10.7.2	Example: Configuring a recipe screen.....	10-23
11	Maintenance/Service	11-1
11.1	Clean screen/keyboard foil	11-1
11.1.1	General information	11-1
11.1.2	Notes on the touch panel.....	11-2
11.2	Replacing the optional backup battery.....	11-3
12	Technical data	12-1
12.1	Dimension drawings.....	12-1
12.1.1	MP 270B 10" Touch, TP 270 10" dimensions.....	12-1
12.1.2	MP 270B 6" Touch, TP 270 6" dimensions.....	12-2
12.1.3	Dimensions, MP 270B 10" Keys, OP 270 10"	12-3
12.1.4	Dimensions, OP 270 6"	12-4
12.2	Technical data.....	12-5
12.3	EMC requirements	12-8
12.4	Interfaces	12-9

A	Appendix.....	A-1
	A.1 Certificates and Directives	A-1
	A.1.1 Approvals	A-1
	A.1.2 ESD guidelines.....	A-2
	A.2 System alarms	A-3
B	Abbreviations	B-1
	B.1 Abbreviations	B-1
C	Glossary	C-1
	Index	

Tables

Table 1-1	Communication with SIMATIC PLCs	1-11
Table 1-2	Communication with PLCs from other manufacturers	1-11
Table 12-1	9-pin Sub-D plug (pin)	12-9
Table 12-2	9-pin Sub-D socket (configuration via switch).....	12-9
Table 12-3	9-pin Sub-D plug (pin).....	12-10
Table 12-4	RJ45 plug connection.....	12-10
Table 12-5	USB standard plug	12-11

Overview

1.1 Introduction

HMI devices in the middle performance range

The Multi Panel MP 270B, Touch Panel TP 270 and Operator Panel OP 270 extend the product spectrum in the middle performance range.

The HMI devices are based on the innovative standard operating system, Microsoft Windows CE. The robustness and speed of the dedicated hardware solutions are combined with the flexibility of the PC world.

The MP 270B represents the "Multifunctional Platform" product category and is distinguished by its variable deployment. This product category is positioned in the product hierarchy between the process-related, optimized application components, such as operator panels and controllers, and industrial PCs.

The panels TP 270 and OP 270 are downgraded models and less expensive, but still provide convincing functionality

The comprehensive product range allows users to choose the HMI device most suited to their needs. All HMI devices include the following advantages:

- High degree of configuration efficiency
- Configuration simulation on the configuration computer - no PLC required
- Clear display and easy process operation using a Window-Based user interface
- Large selection of predefined screen objects for use during configuration
- Dynamic screen objects, e.g. moving objects
- Uncomplicated and quick handling of recipes and data records in recipe screens and recipe views
- Logging of alarms, process values and login/logout procedures
- Creation of vector graphics using the WinCC flexible configuration software without an external graphics editor,
- Transfer:
 - Automatic switchover to transfer mode
 - Transfer via MPI, PROFIBUS DP, USB and Ethernet
 - Serial transfer
 - Transfer via TeleService
- Standard connections to SIMATIC S5/DP, SIMATIC S7 and SIMATIC 505, as well as to PLCs from other manufacturers

Position in the SIMATIC HMI environment

The HMI devices were designed for the middle performance range. They meet the demands placed on performance, display possibilities and price/performance ratio. In addition, they extend the communication potential of the office world. Customer needs and requests were taken into account in respect to extending data transfer functions, simplifying operation, and increasing acceptance when compared with Windows CE units.

The HMI devices not only support the classic HMI applications (visualization with WinCC flexible) but also additional applications, such as process diagnostics (ProAgent).

1.2 Field of Application

Overview

The HMI device allows graphic display of operating statuses, current process data and errors of connected PLCs. The user can operate and observe the machine or system being monitored easily using the HMI device.

Applicable areas of use include machine and apparatus construction sectors, printing and packing industries, automobile and electrical industries and chemical and pharmaceutical industries.

The high degree of protection (IP65 on the front side) and avoidance of moving storage media, such as hard disks and floppy disks, ensure that the HMI device is suitable for use in rough industrial environments and on site where a machine is located.

Possible installation locations for the HMI device:

- Switching cabinets/consoles
- 19" cabinets/racks (keyboard units)

Connection options for external peripherals (keyboard, mouse and printer) via a USB port, for example, and the possible use of CF and PC cards support multifunctionality. Due to the fact that the HMI device is equipped with high performance basic hardware and has a minimum installation depth means that it fulfills all the requirements for operation in the vicinity of the machine.

The HMI device can be used to:

- Operate and monitor the process using the menu system. Setpoint values or control element settings can be modified by entering values or activating configured softkeys
- Display processes, machines and systems on full-graphic, dynamic screens
- Display and process alarms and tags through output fields, bar graphs or trend curves
- Use input to intervene directly in the running process

1.3 Configuring with WinCC flexible

Introduction

In order to operate a machine or system using an HMI device, the user interface must be configured for the HMI device. This procedure is referred to as the "configuration phase".

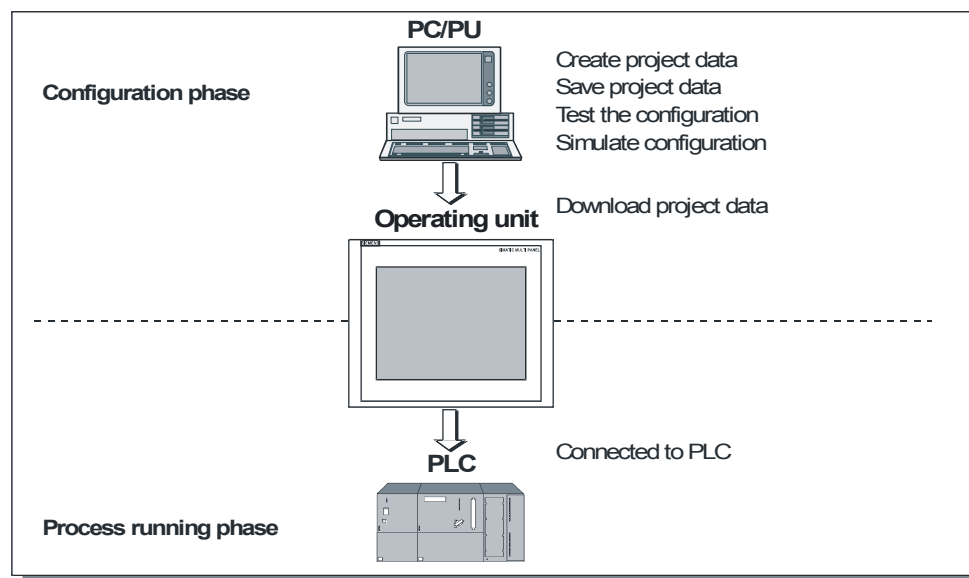

Figure 1-1 Configuration and process running phases

Principle

1. Configuring the functionality of the user interface. This includes the following:
 - Graphics
 - Text
 - Customized functions
 - Operating and indicator objects
 Use a configuration computer (PC or PU) with the WinCC flexible configuration software.
2. Connect the configuration computer to the HMI device.

The following connection options are available:

 - Serial
 - MPI/PROFIBUS DP
 - USB or Ethernet interface
 - Standard modem path
3. Transfer the configuration to the HMI device.
4. Connect the HMI device to the PLC.

Result

The HMI device communicates with the PLC and responds to the program progress in the PLC ("process running phase") according to the information configured.

1.4 Features

Overview of MP 270B 10", OP 270 10" and TP 270 10"

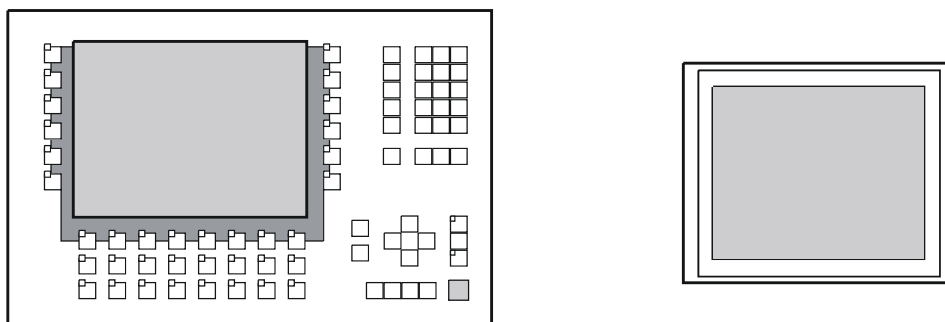

Features		MP 270B 10" Keys	MP 270B 10" Touch	OP 270 10"	TP 270 10"
Processor	Type	RISC CPU			
Memory for configuration	Capacity (max.)	4 MB		2 MB	
Software	Operating system	Microsoft Windows CE			
Interfaces	Interfaces for connecting PLC, PC/PU, printer, network, external mouse and keyboard	<ul style="list-style-type: none"> • 2 x RS 232, 1 x RS 422, 1 x RS 485 • 1 x PC card slot • 1 x CF card slot • 1 x USB • 1 x Ethernet (RJ45) 		<ul style="list-style-type: none"> • 2 x RS 232, 1 x RS 422, 1 x RS 485 • 1 x CF card slot • 1 x USB 	
Color display	Type	TFT LCD	TFT LCD with touch panel	STN LCD	STN LCD with touch panel
	Active screen diagonals	10,4 "			
	Resolution (pixels)	640 x 480			
	Possible colors	256			
	Back-lighting	CCFL tubes			
Membrane keyboard	System keys with dedicated functions	38 (3 with LEDs)	-	38 (3 with LEDs)	-
	Softkeys with configurable functions	36 (28 with LEDs)	-	36 (28 with LEDs)	-
	Those for local assignment	20 (12 with LEDs)	-	20 (12 with LEDs)	-
	Softkey labeling	With labeling strips	-	With labeling strips	-

Features		MP 270B 10" Keys	MP 270B 10" Touch	OP 270 10"	TP 270 10"
Acoustic acknowledgement	In the case of touch control	-	x	-	x
Special features	DP direct keys (touch buttons as I/O periphery)	-	x	-	x
	DP direct keys (keys as I/O periphery)	x	-	x	-
	External memory extension for recipes, logs and alarms etc.	x	x	x	x
	Slot for PC card	x	x	-	-
	Slot for CF card	x	x	x	x

Overview of MP 270B 6" Touch, OP 270 6" and TP 270 6"

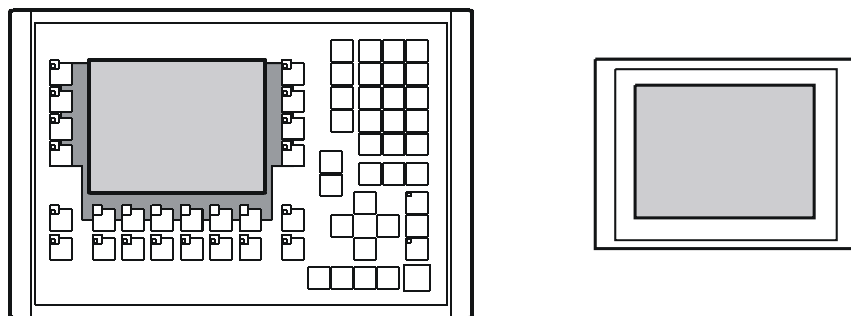

Features		MP 270B 6" Touch	OP 270 6"	TP 270 6"
Processor	Type	RISC CPU		
Memory for configuration	Capacity (max.)	4 MB	2 MB	
Software	Operating system	Microsoft Windows CE		
Interfaces	Interfaces for connecting PLC, PC/PU, printer, network, external mouse and keyboard	<ul style="list-style-type: none"> • 2 x RS 232, 1 x RS 422, 1 x RS 485 • 1 x PC card slot • 1 x CF card slot • 1 x USB • 1 x Ethernet (RJ45) 	<ul style="list-style-type: none"> • 2 x RS 232, 1 x RS 422, 1 x RS 485 • 1 x CF card slot • 1 x USB 	
Color display	Type	TFT LCD with touch panel	CSTN LCD	CSTN LCD with touch panel
	Active screen diagonal	5,7 "		
	Resolution (pixels)	320 x 240		
	Possible colors	256		
	Back-lighting	CCFL tubes		

Features		MP 270B 6" Touch	OP 270 6"	TP 270 6"
Membrane keyboard	System keys with dedicated functions	-	36 (3 with LEDs)	-
	Softkeys with configurable functions	-	24 (18 with LEDs)	-
	Those for local assignment	-	14 (8 with LEDs)	-
	Softkey labeling	-	System-specific with labeling strips	-
Acoustic acknowledgement	In the case of touch control	x	-	x
Special features	DP direct keys (touch buttons as I/O periphery)	x	-	x
	DP direct keys (keys as I/O periphery)	-	x	-
	External memory extension for recipes, logs and alarms etc.	x		x
	Slot for PC card	x		-
	Slot for CF card	x		x

Further information

The creation of projects for HMI devices and functions for the configuration software is described in detail in the "WinCC flexible" user manual and in the WinCC online help.

Information on connecting the HMI device to the PLC is provided in the "WinCC flexible Communication" user manual.

The "Readme.chm" file on the WinCC flexible CD contains the most current information which could not be included in the manuals and online help due to time constraints.

1.5 Functional scope

General information

The following table summarizes the range of functions provided by the HMI device. The numeric values are maximum values which the HMI device is capable of managing. These values are not cumulative. It is not possible to simultaneously configure 4000 alarms and 300 screens each with 400 tags per screen.

The defined values are also limited by the size of the configuration memory.

Function		MP 270B Keys	MP 270B Touch	OP 270	TP 270
Alarms	Number	4000			
	Discrete alarms	Yes			
	Analog alarms	Yes			
	Indicators	Alarm line/Alarm window/alarm view			
	Process values in alarm text	8			
	Length of the alarm text	80 characters (dependent on font)			
	Color-coding of different alarm states	x			
	Warning alarms	x			
	Error alarms	x			
	Type of display	First/last, selectable			
Acknowledge individual alarms	x				
Acknowledge several error alarms simultaneously (group acknowledgement)	16 acknowledgment groups				
ALARM_S	Display S7 alarms	x			
Alarm logging	Output to printer	x			
Volatile alarm buffer	Alarm buffer capacity	512 alarm events, circular buffer			
	View alarms	x			
	Delete	x			
	Print	x			
Alarm acquisition	Time of occurrence	Date/time			
	Alarm events	Arrived, departed, acknowledged			

Function		MP 270B Keys	MP 270B Touch	OP 270	TP 270
Screens	Number	500			
	Text objects	10000 text elements			
	Fields per screen	200			
	Tags per screen	200			
	Operating elements	<ul style="list-style-type: none"> • Button • Switch • I/O field • Graphic I/O field • Symbolic I/O field • Alarm indicator • Alarm view • Alarm window • Recipe view • Bar • Trend view • Slider control • Gauge • Date / time field • Clock • User view • Status force • Sm@rtClient view • Symbol library 			
	Operator prompting				
	Help text	x	x	x	x
	Animation	x	x	x	x
	Unhide/hide objects	x	x	x	x
	Softkey icons	x	-	x	-
Tab order					
LEDs in softkeys	x	-	x	-	
		x	-	x	-
	Fixed window	x			
Tags	Number	2048 ¹⁾			
Limit value monitoring	Input/output	x			
Conversion functions	Input/output	x			

Function		MP 270B Keys	MP 270B Touch	OP 270	TP 270
Help text	Lines/characters	7/35 (dependent on font)			
	For alarms	x			
	For screens	x			
	For screen objects				
	I/O field	x	x	x	x
	Symbolic I/O field	x	x	x	x
	Graphic I/O field	x	x	x	x
	Button	x	-	x	-
	Switch	x	-	x	-
	Hidden button	x	-	x	-
Logging	Alarms	x			
	Tags	x			
	Log type	Circular/sequential log			
	Number of logs	20			
	Number of tags for logging	20			
	Number of sequential logs	400			
	Entries per log	500000, limited by storage medium ²⁾			
	Memory location	<ul style="list-style-type: none"> • PC card • CF card • Ethernet 	<ul style="list-style-type: none"> • CF card • Ethernet (optional) 		
Lists	Number	500			
	Graphics lists	400			
	Text lists	500			
Print functions	Hardcopy of the screen content, also in color	x			
	Direct alarm logging	x			
	Freely configurable logs	x			
Safety	Number of user groups	50			
	No. of users	50			
	No. of authorizations	32			
Recipes	Number	300			
	Data records per recipe	500, limited by storage medium ²⁾			
	Elements per recipe	1000			
	Recipe memory	64 KB (integr. Flash, expandable)			
Online languages	Number of languages	5			
	Project languages (with system alarms)	Chinese (simplified), Chinese (traditional), Czechoslovakian, Danish, Dutch, English, Finnish, French, German, Greek, Hungarian, Italian, Japanese, Korean, Norwegian, Polish, Portuguese, Russian, Spanish, Swedish, Turkish			
PU functions (status force)	SIMATIC S5	x			
	SIMATIC S7	x			

Overview

1.5 Functional scope

Function		MP 270B Keys	MP 270B Touch	OP 270	TP 270
Scheduler	Trigger functions cyclically or once			x	
VBScript	User-specific expansions of functionality			x	
	Number of scripts			50	
Connections ³⁾	Number			6	

- 1) Maximum total number for PowerTags and internal tags
- 2) Storage media refers to PC cards, CF cards and network drives
- 3) With SIMATIC S7

1.6 Communication with PLCs

The following tables list the PLCs which can be connected to the HMI device.

Table 1-1 Communication with SIMATIC PLCs

PLC	MP 270B Keys	MP 270B Touch	OP 270	TP 270
SIMATIC S5 AS511 ¹⁾			x	
SIMATIC S5 DP			x	
SIMATIC S7-200			x	
SIMATIC S7-300/400			x	
SIMATIC 500/505 serial			x	
SIMATIC 500/505 DP			x	
SIMATIC HMI HTTP Protocol			x	
OPC ²⁾	x			-
SIMATIC WinAC			x	
SIMOTION			x	

1) Only via converter cable

2) Data exchange only via XML (connection to OPC-XML server)

Table 1-2 Communication with PLCs from other manufacturers

PLC	MP 270B Keys	MP 270B Touch	OP 270 10"/OP 270 6"	TP 270 10"/TP 270 6"
Allen Bradley DF1			x	
Allen Bradley DH485			x	
LG GLOFA-GM			x	
Modicon MODBUS			x	
Mitsubishi FX			x	
Mitsubishi Protocol 4			x	
GE Fanuc SNP			x	
Omron Hostlink/Multilink			x	

1.7 Options

1.7.1 Hardware options

1.7.1.1 Backup battery

Function of the backup battery

The battery ensures that in the event of a power failure, the HMI device's internal hardware clock continues to run. If no battery is available, the clock continues for approx. three days as long as the HMI device was in operation for 6 to 8 hours, without interruption, beforehand.

The battery is not supplied with the HMI device.

Installation in the MP 270B 10", TP 270 10" or OP 270 10"

1. Secure the battery with two cable ties to the back of the HMI device. The position is indicated by an arrow in the following figures.

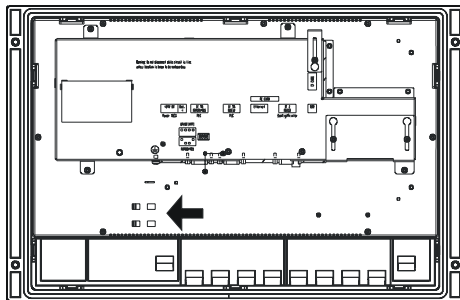

Figure 1-2 MP 270B 10" Keys / OP 270 10"

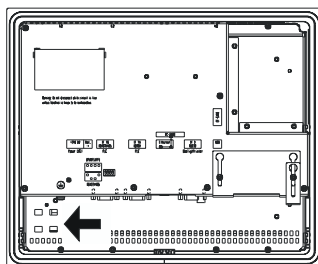

Figure 1-3 MP 270B 10" Touch / TP 270 10"

2. Insert the battery lead connector into the two-pin socket. The plug is coded to prevent reversed poling.

Assembly on MP 270B 6" Touch, TP 270 6" and OP 270 6"

1. Secure the battery to the back of the HMI device with one cable tie. The position is indicated by an arrow in the following figures.

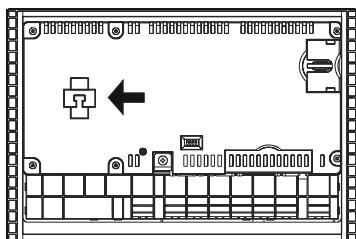

Figure 1-4 OP 270 6"

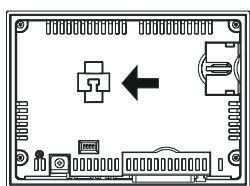

Figure 1-5 MP 270B 6" Touch / TP 270 6"

2. Insert the battery lead connector into the two-pin socket. The plug is coded to prevent reversed poling.

See also

Replacing the optional backup battery (Page 11-3)
Interfaces (Page 4-6)

1.7.1.2 PC card / CF card

Purpose

Changeable PC cards and CF cards can be inserted in the two slots, Slot A and Slot B on the back of the MP 270B. They are not supplied.

The TP 270 and OP 270 have only one slot for CF cards (Slot B).

Changeable memory cards can be used, for example, to store important process data or execute a backup/restore of the internal flash memory.

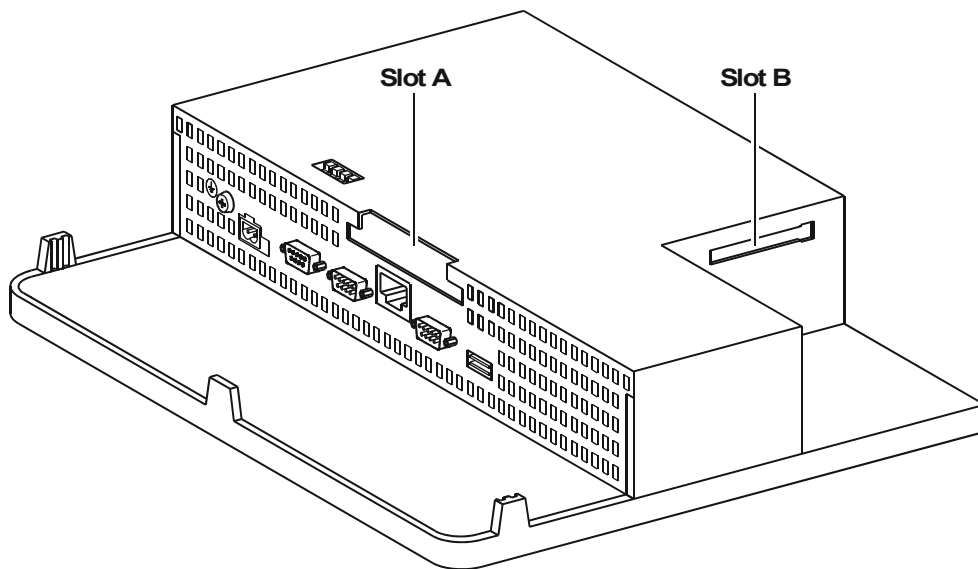

Figure 1-6 Position of the slots (example of MP 270B 10" Keys)

Cards supported

The HMI device supports standard cards which operate with a programming voltage of 5 V:

- Slot A (PC card) (type I and II) (for MP 270B only):
 - ATA Flash card
 - SRAM card
 - NE2000-compatible Ethernet card
- Slot B (CF card) (type I):
 - ATA Flash card
 - NE2000-compatible Ethernet card

Caution

The current limitation is 300 mA per slot.

Remove memory card

Caution

Ensure that the HMI device does not access the memory card during the removal process. Otherwise, the contents of the memory card will be fully destroyed.

1. Terminate access made by the HMI device to the memory card.
If the configuration engineer has defined an operating element linked to the "CloseAllLogs" system function, press the element. Otherwise, press the operating element linked to the "StopRuntime" system function in the configuration. This ends runtime.
2. Wait until the HMI device displays the loader.
Changeover to the loader may take several minutes depending on the size and number of logs stored.
3. Remove the memory card.

Switch off the HMI device with memory card inserted

Caution

Always terminate the runtime software before switching off the voltage supply in order to prevent loss of data.

1. Terminate runtime.
Press the operating element linked to the "StopRuntime" system function in the configuration.
2. Wait until the HMI device displays the loader.
Changeover to the loader may take several minutes depending on the size and number of logs stored.
3. Switch off the power supply.
If the power supply is interrupted during normal operation, the HMI device checks the memory card after power is restored and repairs any defect sectors.

See also

HMI device loader (Page 6-1)

1.7.2 Software options

1.7.2.1 Internet Explorer

Overview

The Internet Explorer supplied with the HMI device has been specially adapted to the Windows CE operating system and has a restricted functional scope (Pocket Internet Explorer). Only simple HTML pages, about 100 kb, can be displayed.

Prior to installation, use the system settings to set 1.5 Mb memory for the DRAM file system.

Caution

If too much memory is provided for the DRAM file system, runtime has too little working memory available. Therefore, in the case of incorrect settings, there is no guarantee that the runtime can run properly.

Caution

The operation of runtime together with the Internet Explorer can only be guaranteed when the run-capable configuration (*.fwx) generated is a maximum of 2 Mb.

The installation of Internet Explorer is performed using the ProSave service tool or WinCC flexible configuration software.

Files created in Internet Explorer, e.g. Favorites, are stored in the DRAM file system. The DRAM file system is deleted when the unit is switched off. However, using the system settings (OP Properties > Persistent Storage > Save Files), it is possible to backup the data currently available in the DRAM file system to the Flash memory. When the device is started up, the backup data is automatically restored.

If you remove the Internet Explorer, the files created from Internet Explorer must also be deleted. To do this, delete the files in the DRAM file system using the standard Explorer. Then backup the DRAM file system ("OP Properties > Persistent Storage > Save Files").

Reset the size of the DRAM file system to the preset value of 2 Mb.

Note

The initial configuration can be restored simply by updating the operating system.

See also

System (Page 6-15)

Update operating system (Page 7-18)

Transferring options (Page 7-22)

Safety notes and general information

2.1 Safety notes

Work on the cabinet



Warning**Danger, high voltage**

Opening the cabinet will expose high voltage parts. Contact with these parts could be fatal.
Switch off the power supply to the cabinet before opening it.

High frequency radiation

Notice**Exceptional operating situations**

High-frequency emissions, e.g. from cell phones, can cause exceptional operating situations.

2.2 General information

Use in industrial areas

The HMI device is designed for use in industrial environments. It complies with the following standards and norms:

- Requirements concerning interference immunity EN 61000-6-4: 2001
- Requirements related to interference immunity EN 61000-6-2: 2001

Use in residential areas

If the HMI device is used in a residential area, the measures related to limiting the emission of radio interference Class B complying to EN 55011 must be met.

Appropriate measures to limit the emission of Class B radio interference include the following:

- Installation of the HMI device in a grounded cabinet
- Use of filters in electrical supply lines

Plan deployment

3.1 Transport

Only unpack the HMI device at its location of use.

Notice

When transporting the HMI device in low temperature areas or areas with extreme temperature fluctuations, ensure that no condensation develops.

The HMI device must be at room temperature before startup. Do not attempt to warm the device using direct heat. If condensation should occur, only switch on the HMI device after waiting approximately 4 hours.

Problem-free, reliable operation of the HMI device requires proper transport, storage, positioning and assembly as well as careful operation and maintenance.

Failure to meet these requirements voids the rights to claims under the terms of warranty.

Notice

The HMI device was function-tested before shipping. If a fault occurs nevertheless, please enclose a full account of the fault when returning the device.

3.2 Installation notes

Electromagnetic compatibility

The HMI device fulfills the requirements requirements as stipulated by German law on EMC as well as the EMC guidelines of the European Union.

Installation in grounded metal cabinets, e.g. 8 MC cabinet complying to Siemens catalog NV21, ensures compliance to EN 61000-4-2.

Installing HMI devices to conform to EMC requirements

A PLC design which is compliant with EMC requirements and uses interference-proof cables is required for error-free operation. The "Guidelines for Interference-Free Construction of PLCs" and the "PROFIBUS network Manual" are installation references for the HMI device.



Caution

Only shielded cables are permitted for all signal connections.

Screw or lock all plug connections.

Do not install signal lines in the same cable ducts as power cables.

Siemens AG refuses to accept liability for malfunctions and damage arising from use of self-made cables or cables from other manufacturers.

Conditions for use

The HMI device is intended for installation in weatherproof, permanent locations. The conditions for the use of the HMI device exceed the requirements as outlined in DIN IEC 60721-3-3 in the following classes:

- Class 3M3 (mechanical requirements)
- Class 3K3 (climatic requirements)

Use with additional measures

The HMI device may not be used in the following circumstances without implementation of additional measures:

- In locations with a high degree of ionizing radiation
- In locations with extreme operating conditions resulting from situations such as the following:
 - corrosive vapors or gases
 - strong electrostatic or magnetic fields

- In systems which require special monitoring facilities. For example:
 - elevator systems
 - in particularly hazardous locations

The HMI device may be installed in a cabinet as an additional measure.

See also

EMC requirements (Page 12-8)

3.3 Installation locations and type of protection

Installation location

The HMI device is designed for installation in the front panels of cabinets and consoles. The MP 270B 10" Keys and OP 270 10" are also designed for installation in 19" cabinets and racks.

Cut an installation cut-out in a front panel. The thickness of the front panel must not exceed 6 mm. Additional holes for securing the HMI device are not necessary because a clamping mechanism is available.

Degree of protection

Install the HMI device to meet the minimum requirements for IP54 degree of protection. The IP65 degree of protection for the front panel can only be ensured when the seal on the front plate of the HMI device is fitted correctly.

Notice

The NEMA 4 or IP65 degrees of protection are only ensured when

- in the case of MP 270B 6", OP 270 6" or TP 270 6", the plate thickness of the installation support is at least 2 mm

- in the case of MP 270B 10", OP 270 10" or TP 270 10", the plate thickness of the installation support is at least 2.5 mm

Caution

The systems ability to be waterproof and dustproof as per the section "Approvals" is only guaranteed when the following is met:

- Material thickness of installation cut-out: 2 to 6 mm (MP 270B 6", OP 270 6" or TP 270 6") and 2.5 to 6 mm (MP 270B 10", OP 270 10" or TP 270 10")
 - Deviation of the installation cut-out from the horizontal related to the overall dimensions of the HMI device: = 0.5 mm
 - Permissible surface roughness in the area of the seal: max. 120 µm (R_z 120)
-

Ambient conditions

Caution

If the maximum permissible ambient temperature is exceeded, do not operate the HMI device without external ventilation.

Otherwise, the HMI device may be damaged and the approvals listed in the Section "Approvals" and the terms of warranty are void.

See also

Approvals (Page A-1)

Technical data (Page 12-5)

3.4 Producing the installation cut-out

Select position for the installation cut-out



Caution

To prevent the HMI device from overheating during operation:

- The angle of inclination from vertical installation may not exceed a maximum of $\pm 35^\circ$
 - Do not expose the operating unit to direct sunlight
 - Ensure that the ventilation slits in the housing are not obstructed
-

Installation cut-out

MP 270B 10" Touch, TP 270 10"

Notice

The following air flow requirements must be maintained following installation:

- 100 mm above the HMI device
- 50 mm below the HMI device
- 15 mm at the sides of the HMI device

When using plug-in boards, ensure sufficient space is provided to insert or remove them.

For installation in a front panel, the MP 270B 10" Touch or TP 270 10" requires an installation cut-out (WxH) of 310 ⁺¹ mm x 248 ⁺¹ mm. The thickness of the front panel must not exceed 6 mm.

MP 270B 6" Touch, TP 270 6"

Notice

The following air flow requirements must be maintained following installation:

- 150 mm above the HMI device
- 100 mm below the HMI device
- 15 mm at the sides of the HMI device

When using plug-in boards, ensure sufficient space is provided to insert or remove them.

For installation in a front panel, the MP 270B 6" Touch or TP 270 6" requires an installation cut-out (WxH) of 198 ⁺¹ mm x 142 ⁺¹ mm. The thickness of the front panel must not exceed 6 mm.

MP 270B 10" Keys, OP 270 10"

Notice

The following air flow requirements must be maintained following installation:

- 50 mm above the HMI device
- 15 mm below the HMI device
- 15 mm at the sides of the HMI device

When using plug-in boards, ensure sufficient space is provided to insert or remove them.

For installation in a front panel, the MP 270B 10" Keys or TP 270 10" requires an installation cut-out (WxH) of 436 ⁺¹ mm x 295 ⁺¹ mm. The thickness of the front panel must not exceed 6 mm.

OP 270 6"

Notice

The following air flow requirements must be maintained following installation:

- 100 mm above the HMI device
- 50 mm below the HMI device
- 15 mm at the sides of the HMI device

When using plug-in boards, ensure sufficient space is provided to insert or remove them.

For installation in a front panel, the OP 270 6" requires an installation cut-out (WxH) of 282 ⁺¹ mm x 178 ⁺¹ mm. The thickness of the front panel must not exceed 6 mm.

Installation and connection

4.1 Check shipment

Inventory the contents of the shipment. Check for visible signs of damage which may have occurred during shipment.

Notice

Do not install damaged parts. If parts are damaged, contact ...

Keep the documentation supplied. This belongs to the HMI device and may be required when commissioning in the future.

4.2 Installation of the HMI device

4.2.1 Installing the MP 270B Keys or OP 270

Prior to installation

If you want to change the labels on the softkeys, change the labeling strips before installing the HMI device.

Installation in 19" cabinets/racks

Refer to the information provided by the respective cabinet or rack manufacturer to install the device in a 19" cabinet/rack.

Installation dimensions of standard 19" cabinets:

- Width: 19" (482.6 mm)
- Height: 7 HE (310 mm)

Secure the HMI device to the rails using four screws

Installation in front panels

The MP 270B Keys and OP 270 can be secured in the installation cut-out using spring terminals. When secured using spring terminals, no additional holes for securing the device are required in the front panel.

Spring terminals used in conjunction with an outer seal can achieve IP65 degree of protection. Screwed supports achieve the degree of protection IP54.

Installing the MP 270B Keys or OP 270 in the front panel:

1. Check that the installation seal is fitted on the HMI device.
Do not mount the installation seal turned inside out. This can lead to gaps in the installation cut-out.
2. Working from the front, insert the HMI device into the installation cut-out.
3. Insert the hooks of the spring terminals into the corresponding recesses in the housing of the HMI device.

The individual positions are indicated in the figures below by means of arrows.

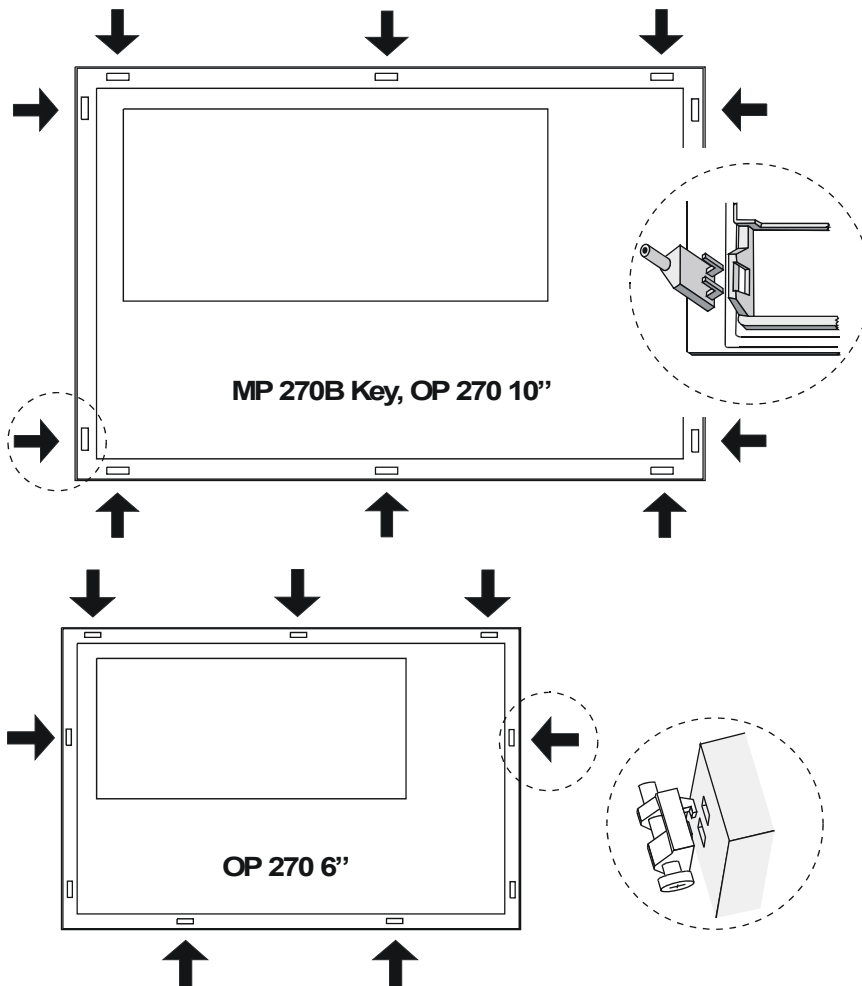

If necessary, the OP 270 6" can be additionally held by two further spring terminals inserted in the two bottom recesses on the side of the HMI device. They are not supplied with the OP 270 6" .

4. Working from the back, secure the MP 270B 10" Keys or OP 270 10" into the front panel using an Allen wrench. Use a Phillips screwdriver for the OP 270 6".

Caution

Check the fit of the rubber seal on the front side. It must not protrude from the HMI device.

Over tightening the screws will damage the HMI device.

See also

Installation locations and type of protection (Page 3-3)

Dimensions, OP 270 6" (Page 12-4)

Labeling the softkeys (Page 5-8)

Dimensions, MP 270B 10" Keys, OP 270 10" (Page 12-3)

4.2.2 Installing the MP 270B Touch or TP 270 10"

Installation in front panels

The MP 270B Touch and TP 270 can be secured in the installation cut-out using spring terminals. When secured using spring terminals, no additional holes for securing the device are required in the front panel.

Spring terminals used in conjunction with an outer seal can achieve IP65 degree of protection. Screwed supports achieve the degree of protection IP54.

Installing the MP 270B Touch or TP 270 in the front panel:

1. Check that the installation seal is fitted on the HMI device.

Do not mount the installation seal turned inside out. This can lead to gaps in the installation cut-out.

2. Working from the front, insert the HMI device into the installation cut-out.

3. Insert the hooks of the spring terminals into the corresponding recesses in the housing of the HMI device.

The individual positions are indicated in the figures below by means of arrows.

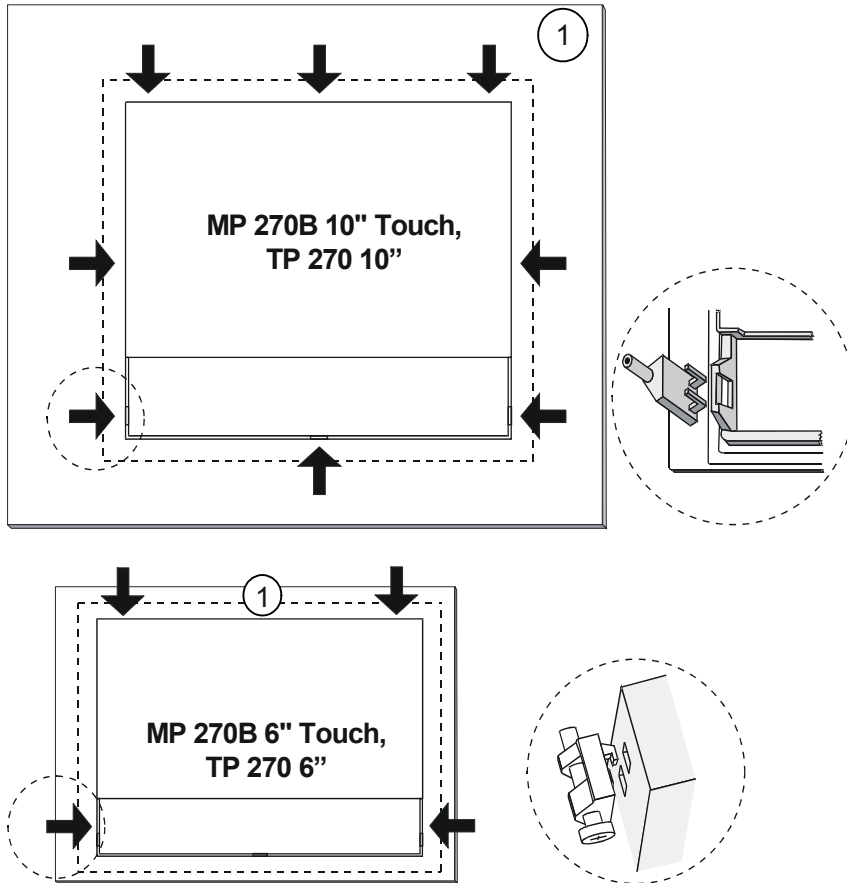

1 Front panel

4. Working from the back, secure the MP 270B 10" Touch or TP 270 10" in the front panel using an Allen wrench. Use a Phillips screwdriver for the MP 270B 6" Touch and TP 270 6".

Caution

Check the fit of the rubber seal on the front side. It must not protrude from the HMI device.

Over tightening the screws will damage the HMI device.

See also

MP 270B 10" Touch, TP 270 10" dimensions (Page 12-1)

MP 270B 6" Touch, TP 270 6" dimensions (Page 12-2)

4.3 Connecting the HMI device

4.3.1 Conditions

Requirements

The following condition must be fulfilled before the HMI device is connected electrically:

- The HMI device must be installed according to the information provided in these operating instructions.

Electrical connections

Connect the HMI device in the following sequence:

1. Potential equalization line
2. PLC
3. Configuration computer as necessary
4. Peripheral equipment as necessary
5. Power supply

Notice

Connection sequence

Carefully follow the sequence of HMI device connections. Failure to do so may result in damage to the HMI device.

When disconnecting the connections, it is essential to proceed in the reverse sequence.

4.3.2 Interfaces

Interfaces

The figure below illustrates the arrangement of the interfaces on underside of the HMI device, exemplified by the MP 270B 10" Keys.

Notice

In the case of the TP 270 and OP 270, the interfaces for the PC card and Ethernet interface on-board are missing. To enable an Ethernet connection, the devices require a CF card.

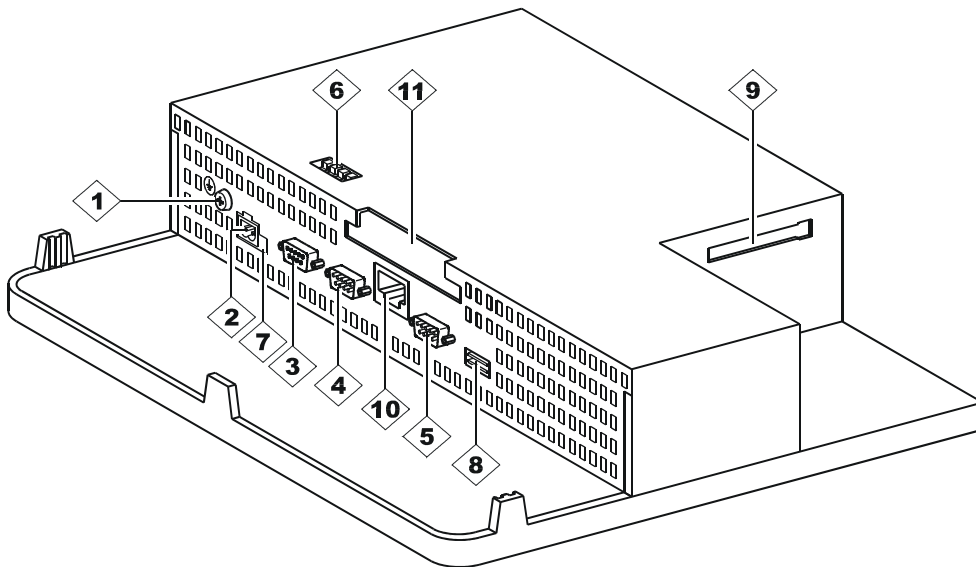

Figure 4-1 Arrangement of the interfaces (example, MP 270B 10" Keys)

No.	Description	Application
1	Ground connection	For connection to rack ground
2	Power supply	Connection to power supply +24 V DC)
3	Interface IF1B	RS 422/RS 485 (floating) for PLC, PC, PU
4	Interface IF1A	RS 232 for PLC
5	Interface IF2	RS 232 for PC, PU, printer
6	Switch	To configure interface IF1B
7	Battery connection	Connection for optional backup battery
8	USB interface	Connection for external keyboard, mouse, etc.
9	Slot B	For CF card
10	Ethernet interface (for MP 270B only)	Connection of an RJ45 Ethernet line
11	Slot A (for MP 270B only)	For PC card

Notice

Connecting a USB distributor (USB hub) to the HMI device's USB interface can cause a restriction in the functionality of the connected USB devices and the HMI device.

Therefore, the simultaneous or alternating operation of USB devices connected via a USB hub on the HMI device's USB interface is not approved.

This applies to USB hubs both with and without an internal power supply.

Notice

The connection and operation of USB memory media (e.g. USB stick) on the HMI device's USB interface has not been approved.

Communication options

The table indicates the periphery units with which the HMI device can communicate.

Device	Interconnection	Interface
SIMATIC S5	AS511 (only via converter cable) PROFIBUS DP	IF1A IF1B
SIMATIC S7	MPI PROFIBUS DP Industrial Ethernet	IF1B IF1B Ethernet ¹⁾
SIMATIC 505	RS 232 RS 422/RS485	IF1A IF1B
Further support	RS 232 RS 422/RS485	IF1A IF1B
Configuration computer	RS 232	IF2
Printer		
Local printer	RS 232 / USB	IF2 / USB
Network printer	Network	Ethernet ¹⁾
External keyboard/mouse		USB

1) The OP 270 and TP 270 require a CF card for an Ethernet connection.

See also

Connecting the power supply (Page 4-17)

Interfaces (Page 12-9)

Backup battery (Page 1-12)

Connecting the PLC (Page 4-13)

Technical data (Page 12-5)

4.3.3 Connecting the potential equalization

Ground connection



Connect the grounding connection of the HMI device to the rack ground. Use the grounding screw provided and a conducting cable with a diameter of at least 2.5 mm².

Potential difference

Potential differences can occur between separate system parts which leads to high equalizing currents. An example would be when line shields are applied on both sides and grounding occurs on different system parts.

The cause of potential differences could be different mains power feed.

General requirements of potential equalization

Potential equalization lines must be installed to reduce potential differences to an extent that guarantee problem-free operation of the electronic components. Observe the following when setting up potential equalizations:

- The lower the impedance of the potential equalization lead or the larger the cross-section of the potential equalization lead, the higher the efficiency of the potential equalization.
- If two system parts are connected to each other by shielded data lines whose shielding on both sides is connected to the grounding/protective conductor, the impedance of the additionally laid potential equalization lead may be at the most 10% of the shield impedance.
- The cross-section of a potential equalization line must be sized for the maximum equalizing current which flows. In practice, potential equalization lines between cabinets with a minimum cross-section of 16 mm² have proven sufficient.
- Use potential equalization lines made of copper or galvanized steel. Connect the potential equalization lines to the grounding/protective conductor with large area contact and protect them from corrosion.
- Clamp the shielding of the data line on the HMI device flush and as close as possible to the potential equalization rail using cable clips.
- Lay the potential equalization and data lines parallel to each other and within the minimum distance of each other (refer to following Figure, Point 6).

Notice

Potential equalization line

Cable shields are not suitable for potential equalization. Only use the intended potential cable prescribed. Potential cable, for example, must have a minimum cross-section of 16 mm². When setting up MPI and PROFIBUS DP networks, ensure cables with a sufficient cross-section are used otherwise the interface modules may be damaged or even destroyed.

Connection configuration

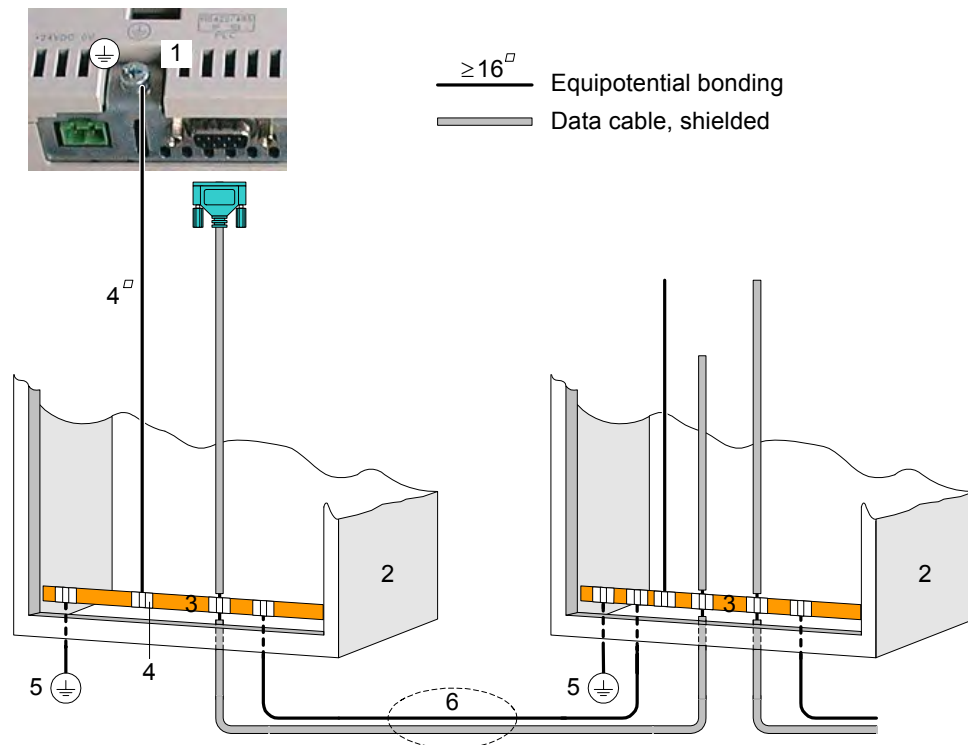

Figure 4-2 Setting up potential equalization in the HMI device

- 1 Grounding connection on the HMI device
- 2 Cabinet
- 3 Voltage bus
- 4 Cable clip
- 5 Grounding connection
- 6 Parallel layout of potential equalization and data lines

4.3.4 Connecting peripheral equipment

4.3.4.1 Connect printer

Connection configuration

The figure below illustrates how to connect a printer to the HMI device. The HMI device supports the following printer standards:

- compatible with ESC/P, 9-pin ESC/P or ESC/P2 (EPSON)
e.g. EPSON LQ 300+
- compatible with PCL3 (Hewlett Packard)
e.g. Brother HL 1450

USB printers can still be used for PCL and Epson9 modes.

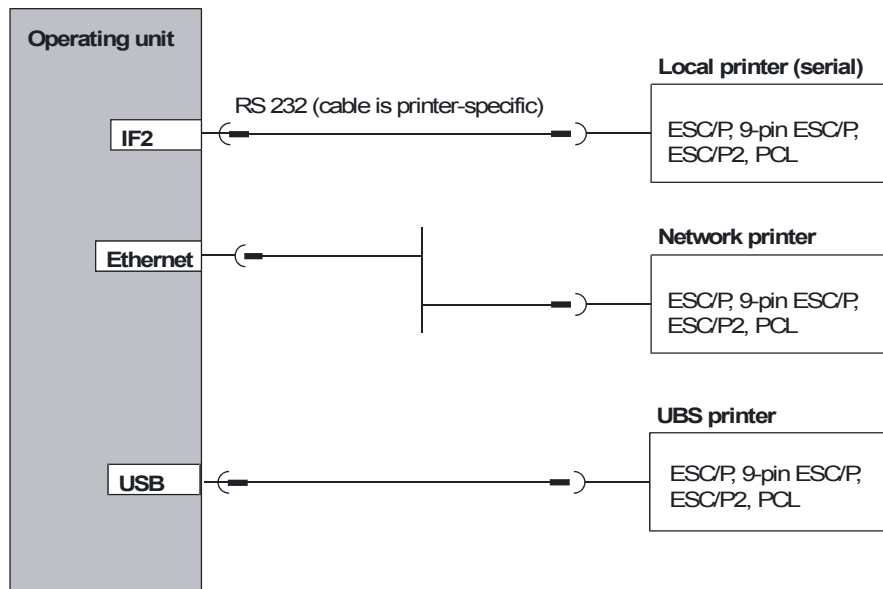

Figure 4-3 Printer connection configuration

Notice

Connecting a USB distributor (USB hub) to the HMI device's USB interface can cause a restriction in the functionality of the connected USB devices and the HMI device.

Therefore, the simultaneous or alternating operation of USB devices connected via a USB hub on the HMI device's USB interface is not approved.

This applies to USB hubs both with and without an internal power supply.

Notice

Only use a cable with braided metal screening grounded at each end for connecting the HMI device and printer.

Deactivate the "Printer" option in the "Serial Transfer Remote Control" setting in the Windows CE Control Panel if a serial printer is connected to the HMI device via the IF2 interface.

Some printers may require the ASCII character set used in the project to also be defined on the printer.

If a serial printer is connected, the following printer settings are required:

- RS 232, whereby only the RxD, TxD and GND signals are required,
- 8 data bits
- 1 stop bit
- No parity
- Baud rate between 9600 and 57600, printer-dependent
- XON / XOFF protocol

The Siemens Catalog ST 80 contains the printers approved by Siemens AG. A current list of approved printers is available on the Internet.

Note

Printer documentation

Refer to the information provide by the printer manufacturer when connecting the printer.

See also

Interfaces (Page 12-9)

Printer (Page 6-11)

4.3.4.2 Connect external keyboard and mouse

Connection configuration

The figure below illustrates how to connect a keyboard or mouse to the HMI device's USB interface. A keyboard or mouse can be connected and disconnected during normal operation.

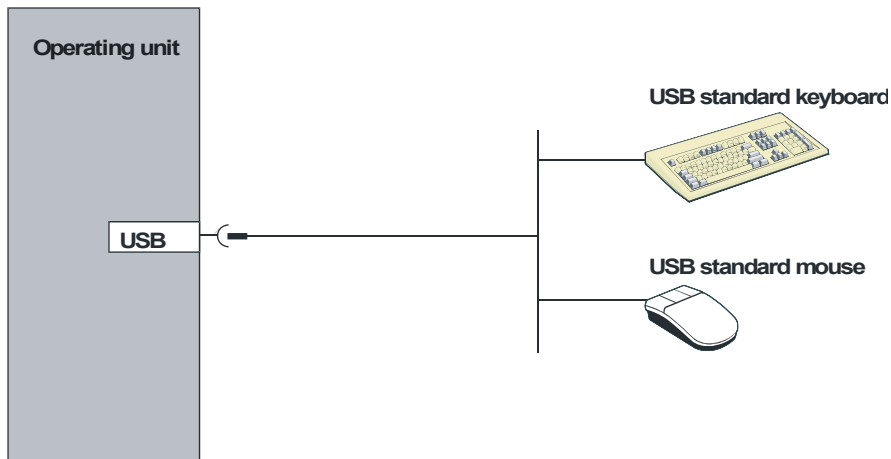

Figure 4-4 Connection configuration for external keyboard and mouse

Notice

Connecting a USB distributor (USB hub) to the HMI device's USB interface can cause a restriction in the functionality of the connected USB devices and the HMI device.

Therefore, the simultaneous or alternating operation of USB devices connected via a USB hub on the HMI device's USB interface is not approved.

This applies to USB hubs both with and without an internal power supply.

Notice

Use a standard mouse and keyboard with a "USA/International" keyboard layout. Commercially available USB devices do not normally meet the higher industrial demands relating to interference resistance and can have negative effects on the HMI device.

The power consumption must not exceed 500 mA with the USB units connected.

See also

Operation with external keyboard/mouse (Page 5-12)

4.3.5 Connecting the PLC

Connection configuration

The figure below illustrates the basic connection possibilities between the HMI device and PLC. Standard cables are available for the connections shown (refer to the ST80 catalog).

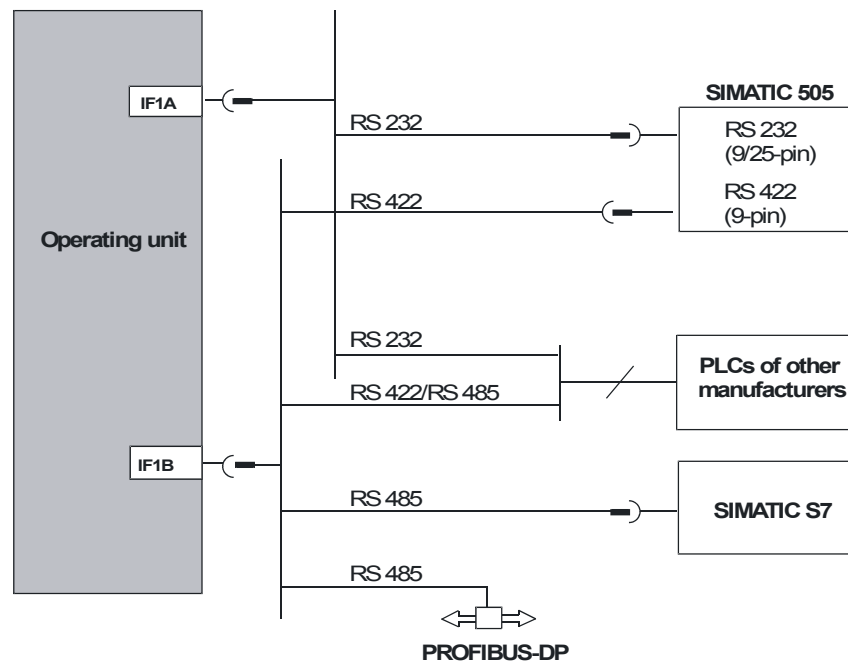

Figure 4-5 Connection configuration for PLCs

- SIMATIC S7
Use only the approved cables for connection to a SIMATIC S7.
- IF1A / IF1B
To enable communication using the serial interface, connect either the IF1A (RS 232) or IF1B (RS 422/485), but not both. The IF1B interface can be configured using a switch.
- PROFIBUS DP
Any PROFIBUS-DP bus terminal can be used.

Configure interface IF1B

The IF1B interface can be configured via the switch on the back of the HMI device. This switches over the RS-422 received data and the RTS signal for RS485.

By default, the switch is set for the SIMATIC S7 PLC.

The following table shows the permissible switch settings.

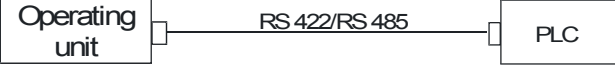
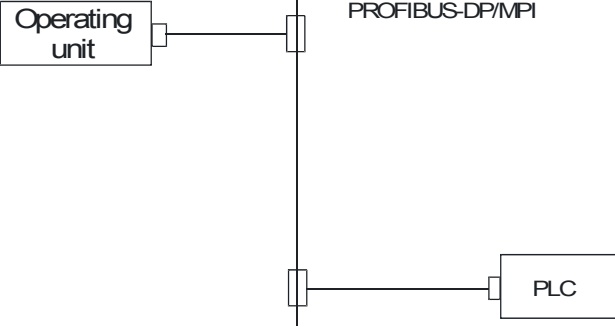
Communication	Switch settings
	<div style="text-align: center;"> 4 3 2 1 <input checked="" type="checkbox"/> <input checked="" type="checkbox"/> <input checked="" type="checkbox"/> <input checked="" type="checkbox"/> <input type="checkbox"/> <input type="checkbox"/> <input type="checkbox"/> <input type="checkbox"/> ON </div> <p>No RTS on connector This is the switch setting on delivery.</p>
	<div style="text-align: center;"> 4 3 2 1 <input checked="" type="checkbox"/> <input type="checkbox"/> <input type="checkbox"/> <input checked="" type="checkbox"/> <input type="checkbox"/> <input checked="" type="checkbox"/> <input checked="" type="checkbox"/> <input type="checkbox"/> ON </div>
	<div style="text-align: center;"> 4 3 2 1 <input type="checkbox"/> <input checked="" type="checkbox"/> <input checked="" type="checkbox"/> <input checked="" type="checkbox"/> <input checked="" type="checkbox"/> <input type="checkbox"/> <input type="checkbox"/> <input type="checkbox"/> ON </div> <p>RTS on Pin 4 (default)</p>
	<div style="text-align: center;"> 4 3 2 1 <input checked="" type="checkbox"/> <input checked="" type="checkbox"/> <input checked="" type="checkbox"/> <input type="checkbox"/> <input type="checkbox"/> <input type="checkbox"/> <input type="checkbox"/> <input checked="" type="checkbox"/> ON </div> <p>RTS on Pin 9 (as PU)</p>
	<div style="text-align: center;"> 4 3 2 1 <input checked="" type="checkbox"/> <input checked="" type="checkbox"/> <input checked="" type="checkbox"/> <input checked="" type="checkbox"/> <input type="checkbox"/> <input type="checkbox"/> <input type="checkbox"/> <input type="checkbox"/> ON </div> <p>No RTS on connector</p>

Compressing the internal program memory with SIMATIC S5



Warning

In the case of the SIMATIC S5, compressing the PLC's internal program memory ("Compress" PU function, integrated FB COMPR) is not permitted if an HMI device is connected. When memory is compressed, the absolute addresses of the blocks in the program memory change. Since the HMI device only reads the address list during startup, it does not recognize the address change and accesses the wrong memory areas.

If you cannot avoid compressing memory during operation, turn off the HMI device before running the compress function.

4.3.6 Connecting the configuration computer

Connection configuration

The figure below illustrates how to connect a configuration computer (PU or PC) to the HMI device for transferring project data.

Standard cables are available for the connections shown (refer to the ST80 catalog).

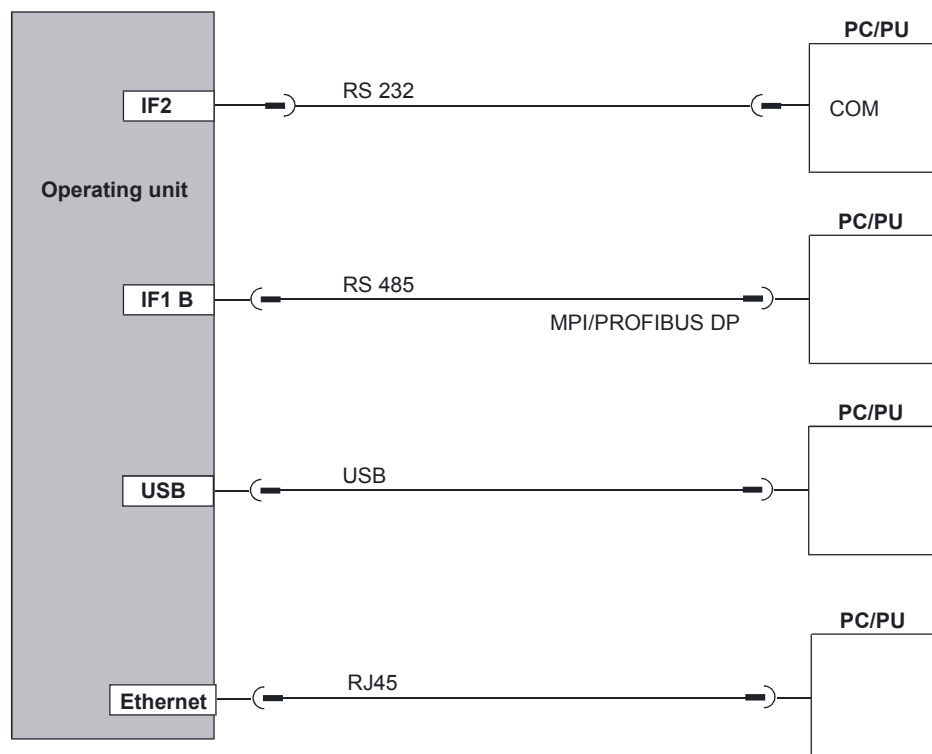

Figure 4-6 Connection configuration for configuration computer

Notice

Use a host-host USB cable for the connection between the HMI device and the configuration computer. Do not use the driver enclosed with the cable for the transfer. Only install the USB driver supplied with WinCC flexible on the configuration computer. This driver is on the WinCC flexible CD under "\Support\DeviceDriver\USB".

4.3.7 Connecting an uninterruptible power supply (UPS)

Connecting a UPS

The following options are available to connect a UPS:

- UPS with serial interface

A UPS with serial interface is connected directly to the HMI device.

A serial connection is used with a "SITOP DC-USV Module A". The driver for detecting and configuring the UPS is contained on the WinCC flexible CD and must be installed on the HMI device using ProSave.

- UPS without serial interface

A UPS without serial interface is connected to the PLC.

The UPS signals the power failure to the connected PLC via a digital signal. The PLC program must then signal the HMI device that runtime must be terminated. To do this, the PLC changes a tag to which the "Exit runtime" function is configured in WinCC flexible.

Note

In order to use an uninterruptible power supply with serial interface on the HMI device, the "Uninterruptible Power Supply (UPS)" option must be loaded on the HMI device.

Connection configuration

The figure below illustrates how to connect an uninterruptible power supply UPS with serial interface to the HMI device.

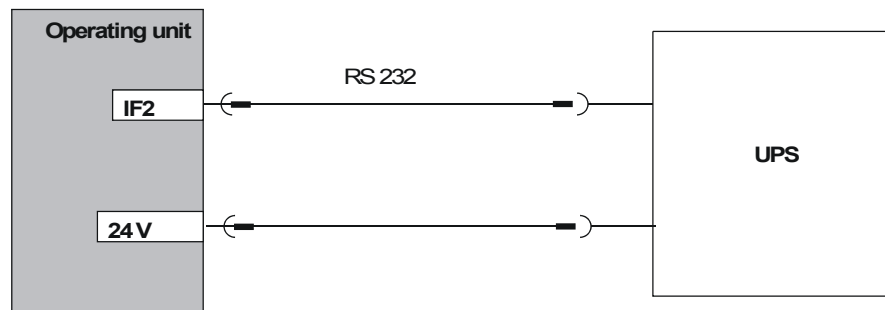

Figure 4-7 Connection configuration for an uninterruptible power supply

See also

UPS (Page 6-16)

Transferring options (Page 7-22)

4.3.8 Connecting the power supply

Connecting the plug-in terminal block

The power supply for the HMI device is connected at the 2-pin plug connector on the underside of the unit. Use the 2-pin terminal block supplied for this purpose. The plug-in terminal block is designed for cables with a cross-section not larger than 2.5 mm².

The figure below illustrates the assignment of the plug-in terminal block.

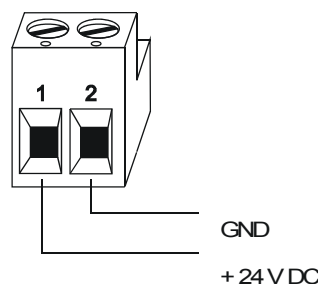

Ensure that the lines are connected properly to the correct terminals. Also note the labeling for the contact pins on the back of the HMI device.

The HMI device is equipped with reverse battery protection.

Notice

Damage

The force of the screwdriver on the screws may cause the socket for the plug-in terminal block in the HMI device to be levered up from the printed circuit board.

Therefore, only connect the wires when the terminal block has been unplugged.

Connecting the power supply

Please refer to Technical Data for information on the power supply requirements.



Caution

Ensure safe electrical insulation of the power supply. Use only power supply units complying with IEC 364-4-41 or HD 384.04.41 (VDE 0100, Part 410).

Only use power supply units which comply to SELV (Safety Extra Low Voltage) and PELV (Protective Extra Low Voltage) standards.

The supply voltage must be within the specified voltage range. Voltages outside this range may cause malfunctions in the HMI device.

If the power supply for the HMI device is not grounded, the communication interface could be destroyed by the potential difference between the HMI device and CPU.

Therefore, connect the 24 V output of the power supply to the potential equalization.

See also

Technical data (Page 12-5)

4.4 Switch on and test the HMI device

Start up

Proceed as follows:

1. Disconnect all connections to external units and remove any cards from the slots.
2. Connect the HMI device to the power supply.
3. Switch on the power supply.

If the HMI device does not start, the connections are probably reversed. In this case, switch of the power supply, reverse the connections and switch the power supply on again.

4. When the HMI device has started, connect the configuration computer or other peripheral equipment to it.

Function test

Initiate a function test following commissioning. The HMI device is functional when one of the following conditions occurs:

- The "Transfer" dialog is displayed
- The loader is displayed
- A project is started

Switching off the HMI device

Switch off the HMI device in the following ways:

- Switch off the power supply, or
- Unplug the terminal strip from the HMI device

Note

If a project is already running on the HMI device, runtime must be terminated before switching the HMI device off.

Use the operating element provided by the project engineer.

Operating elements and indicators

5.1 MP 270B Touch and TP 270

Operating the touchscreen

Notice

Damaging the touchscreen

Operating the touchscreen with hard, sharp or pointed items or in a heavy-handed way can lead to a considerable reduction in its service life and even to a complete failure.

Only press the HMI device's touchscreen with your fingers or a touchscreen pen.

MP 270B 10" Touch and TP 270 10"



MP 270B 6" Touch and TP 270 6"

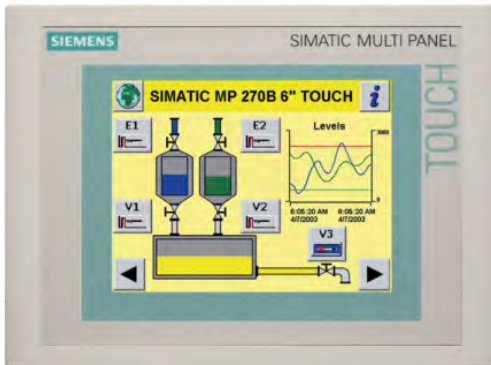

5.2 MP 270B Keys and OP 270

5.2.1 Key pads

Operating the keyboard

Notice

Damaging the keyboard

Operating the keyboard with hard, sharp or pointed items or in a heavy-handed way can lead to a considerable reduction in its service life and even to a complete failure.

Only use your fingers to operate the HMI device keyboard.

MP 270B 10" Keys and OP 270 10" keypads

The keypads on the MP 270B 10" Keys and OP 270 10" consist of two functional blocks. Refer to the figure below. :

- Softkeys
 - Keys <K1> to <K16>
 - Keys <F1> to <F20>
- System keys
 - Alphanumeric keys
 - Cursor keys
 - Control keys

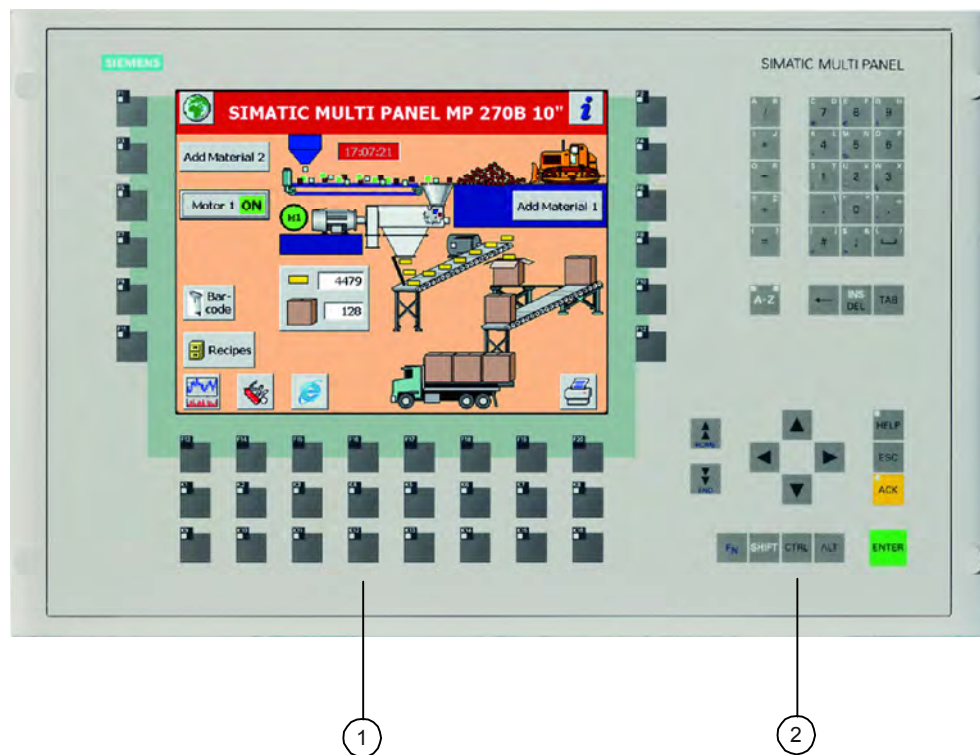

Figure 5-1 Arrangement of the MP 270B 10" Keys and OP 270 10" keypads

- 1 Function keys
- 2 System keys

OP 270 60" keypads

The OP 270 6" keyboard is comprised of two functional keypads. Refer to the figure below.

- Softkeys
 - Keys <K1> to <K10>
 - Keys <F1> to <F14>
- System keys
 - Alphanumeric keys
 - Cursor keys
 - Control keys

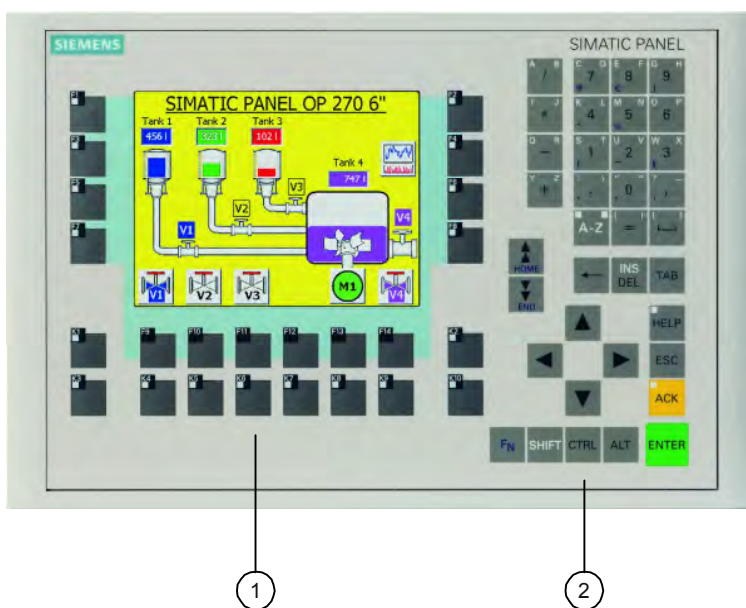

Figure 5-2 OP 270 6" keypad arrangement

- 1 Function keys
- 2 System keys

5.2.2 Function keys

Function keys with global function assignment

A softkey with global function assignment always triggers the same action on the HMI device or in the PLC. The action is independent of the screen currently selected. These actions include:

- Activate screen
- Display current error alarms
- Start screen printout (hardcopy)

All softkeys can be configured with global assignments.

Note

Multiple key operation can trigger unintentional actions.

No more than two softkeys may be pressed simultaneously.

Softkeys with local function assignment

A softkey with local function assignment can trigger different actions on the HMI device or in the PLC. The actions are dependent on the currently active screen (local significance of current screen). A configuration engineer can configure an icon for each softkey. The icon is then positioned at the edge of the screen.

The F-keys can be locally assigned.



Caution

If you press a function key after a screen change, the associated function in the new screen may be initiated before the new screen is displayed.

LED control

The light-emitting diodes (LED) in the function keys can be controlled from the PLC. A luminous or flashing LED can indicate to the operator which key to press according to specific situations.

To trigger the LEDs, the configuration engineer must configure LED tags for the softkeys.

5.2.3 System keys

Control keys

The following control keys serve higher editing and control functions:

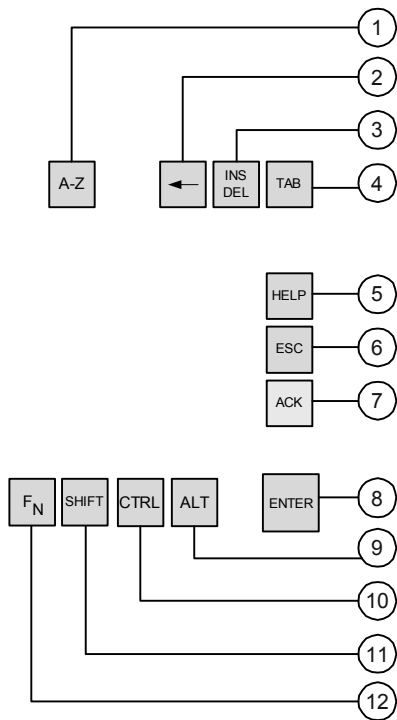

Figure 5-3 Control keys

- 1 Shift (digits/letters)
- 2 Delete character to the left of the current cursor position
- 3 Delete character at the current cursor position.
- 4 Tab
- 5 Display operator notes
- 6 Cancel
- 7 Acknowledge
- 8 Enter
- 9 General control function (for key combinations)
- 10 General control function (for key combinations)
- 11 Shift (upper/lower case)
- 12 Shift (special character)

The system keys <ACK>, <ESC>, <HELP> and <ENTER> can also be assigned functions by the project engineer.

Alphanumeric keys

Use the following alphanumeric keys to enter digits, letters and special characters:

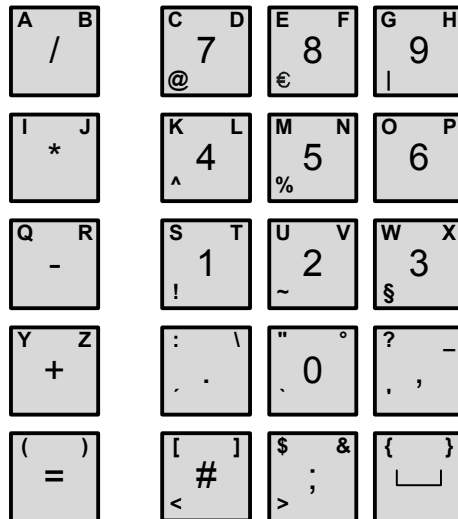

Figure 5-4 Alphanumeric keys

Cursor keys

The cursor keys are used to move the text cursor and to navigate in screens and screen objects. The functions of the keys corresponds to the cursor keys on a standard PC keyboard.

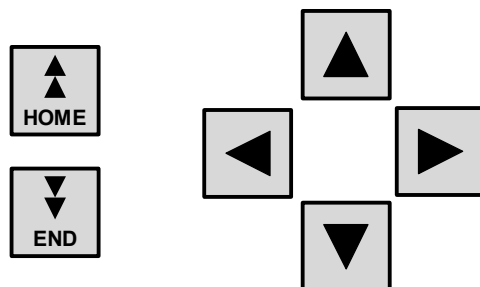

Figure 5-5 Cursor keys

The <HOME> and <END> keys can also be assigned functions by the project engineer.

5.2.4 Labeling the softkeys

Labeling

In the factory state, the softkeys on the keyboard unit are labeled as follows:

- "F1" to "F20" and "K1" to "K16" for MP 270B 10" Keys or OP 270 10"
- "F1" to "F14" and "K1" to "K10" for OP 270 6"

A total of ten labeling strips are inserted from the back for the MP 270B 10" Keys and OP 270 10" HMI device softkeys and eight for the OP 270 6" softkeys. Use these strips to label the HMI device specifically for the system.

Changing labeling strips



Warning

After opening the switching cabinet, certain system parts become accessible which may be conducting dangerously high voltage.

1. Set the HMI device down with the front panel at the bottom.
2. Remove the existing labeling strips.
3. Insert the new labeling strips in the slots of the front panel with the inscription facing down. The individual positions are indicated in the figure by means of arrows.

Caution

Wait for the ink to dry before inserting strips. A keyboard foil which is dirty on the inside cannot be cleaned and can only be replaced at the manufacturer's factory.

MP 270B 10" Keys / OP 270 10"

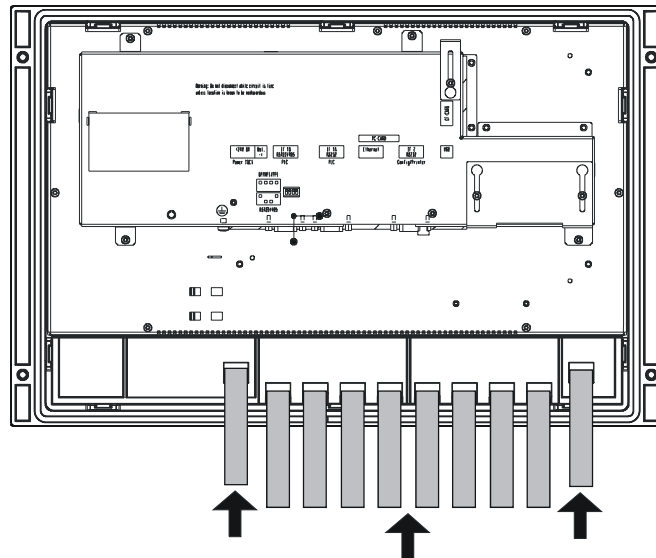

OP 270 6"

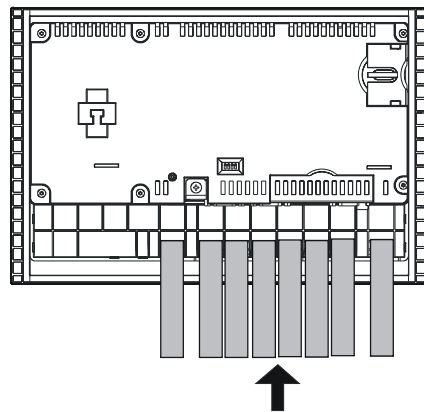

Create labeling strips

Only use transparent foil to create your own labeling strips so that the LEDs in the softkeys remain visible. Label the foil either with a printer or a waterproof felt-tip pen. Cut the strips according to the specifications.

MP 270B 10" Keys / OP 270 10"

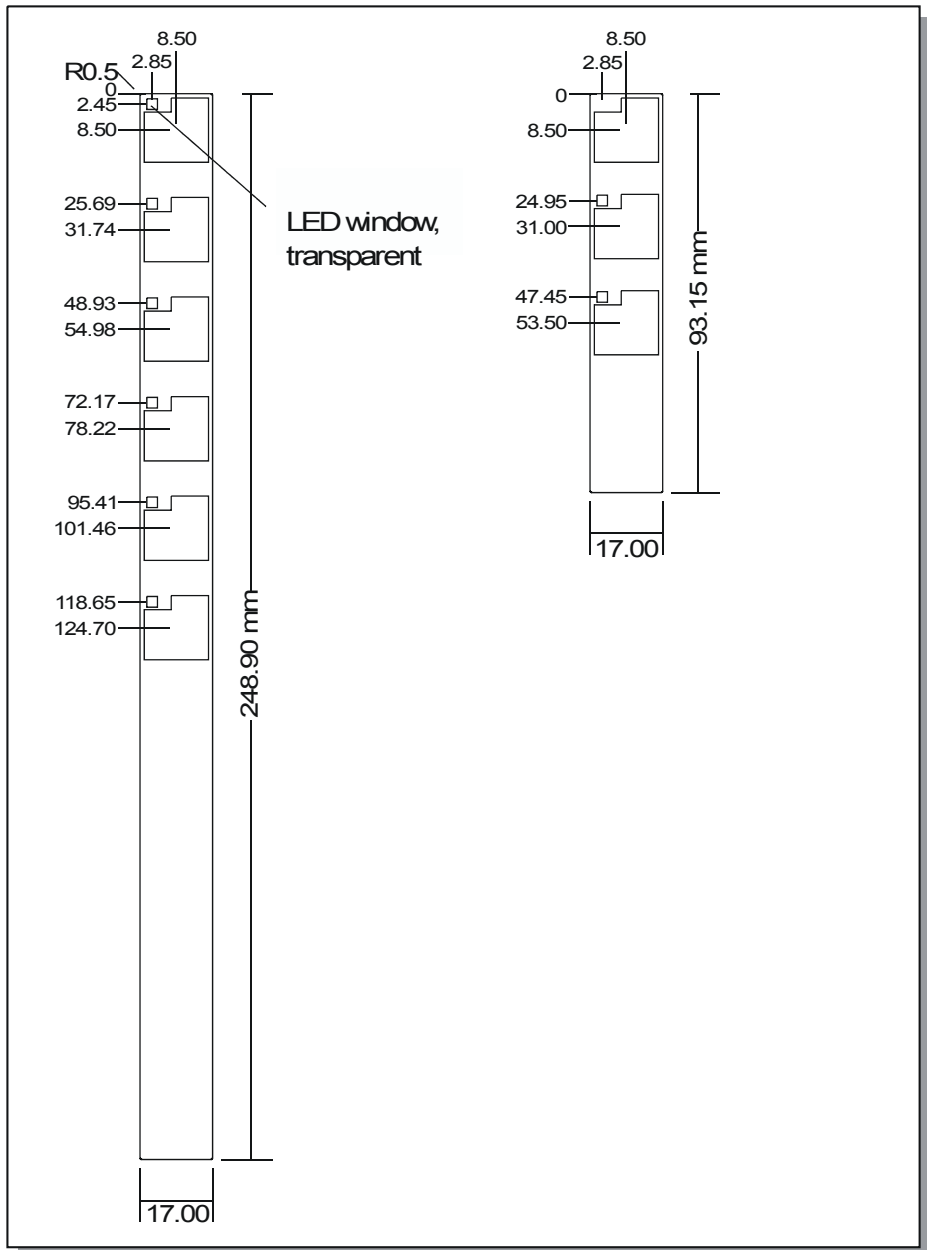

Figure 5-6 MP 270B 10" Keys and OP 270 10" labeling strip dimensions

OP 270 6"

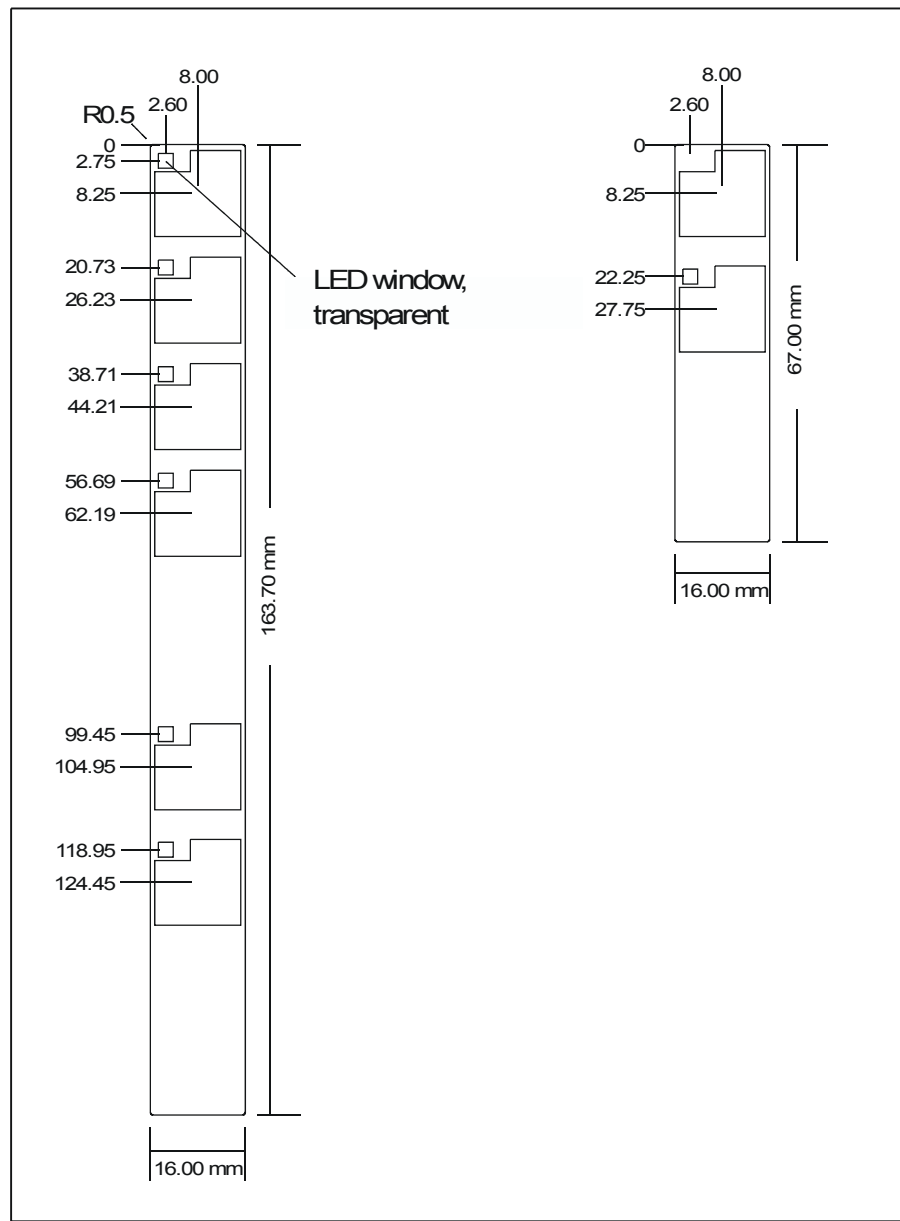

Figure 5-7 Labeling strip dimensions for the OP 270 6"

Printing the labeling strips

The templates for the labeling strips are in the "Slide270.doc" and "Slide270_6.doc" files on the "WinCC flexible" installation CD in the "\\Support\Documents" folder. The files can be edited using the MS Office programs, MS Word or WordPad.

Note the information provided in these files.

5.3 Operation with external keyboard/mouse

Connection

An external keyboard or mouse can be connected to the USB interface on the HMI device. Connection and disconnection are possible during normal operation of the HMI device ("hot plug in/out").

Operation of the HMI device via an external keyboard/mouse is particularly recommended during the commissioning and test phases.

Notice

Commercially available USB devices do not normally meet the higher industrial demands relating to interference resistance and can have negative effects on the HMI device.

USB mouse:

Use a standard mouse.

USB keyboard:

Use a standard keyboard with a USA/International keyboard layout. Operation of the configured function keys is not possible via the external keyboard.

Operation

Operation of the HMI device via a mouse is only slightly different from operation using the touch screen. After connecting a mouse, the mouse pointer  appears on the screen.

When the mouse pointer is positioned on an operable button, the mouse pointer symbol changes  .



Caution

When using a keyboard unit, do not operate the integrated membrane keyboard and external USB keyboard simultaneously. You may trigger an unintended action.

See also

Connect external keyboard and mouse (Page 4-12)

Operating system and configuration

6.1 HMI device loader

Loader

The following figure illustrates the loader which appears briefly during the startup phase of the HMI device.



Figure 6-1 HMI device loader

The loader also appears when runtime has ended.

The loader buttons have the following functions:

- Press the "Transfer" button to switch the HMI device to transfer mode.
- Press the "Start" button to start runtime with a project loaded on the HMI device.
- Press the "Control Panel" button to access the Windows CE Control Panel in which various settings can be defined. The options for the transfer mode can be set here, for example.
- Press the "Taskbar" button to display the Windows toolbar when the Windows CE Start menu is open.

Protect loader with password

It is possible to protect the loader from unauthorized access by assigning a password.

If the password is not entered, only the "Transfer" and "Start" buttons are available. This prevents incorrect operation and increases system or machine security.

Notice

If the password for the loader has been forgotten, it is only possible to access the Control Panel again after updating the operating system.

All the data on the HMI device are overwritten when to operating system is updated.

See also

Open Control Panel (Page 6-2)

6.2 Windows CE Control Panel

6.2.1 Open Control Panel

Windows CE Control Panel

The Windows CE Control Panel can be used to modify the following system settings:



- Date/time
- Network
- Device properties, e.g. brightness and calibration of touchscreens
- Regional settings
- Screensaver
- Screen keyboard
- Volume (touch acknowledgement)
- Printer
- Backup/Restore
- Transfer
- UPS (optional)

Open Control Panel

The following options are available to open the Control Panel:

- During the startup phase:
Press the "Control Panel" button in the loader to open the Windows CE Control Panel. It may be necessary to enter a password.
- During normal operation:
 - Press the operating element, if configured, which is linked to the "OpenControlPanel" system function.
 - The Control Panel can also be opened from the Windows CE Start menu by selecting "Settings > Control Panel".

Keyboard unit:

The Windows CE Start menu can be opened by pressing the key combination  + .

Touch panel unit:

The Windows CE Start menu can be opened by pressing the  button twice (locking key) on the alphanumeric screen keyboard.

Result

The Control Panel is opened.

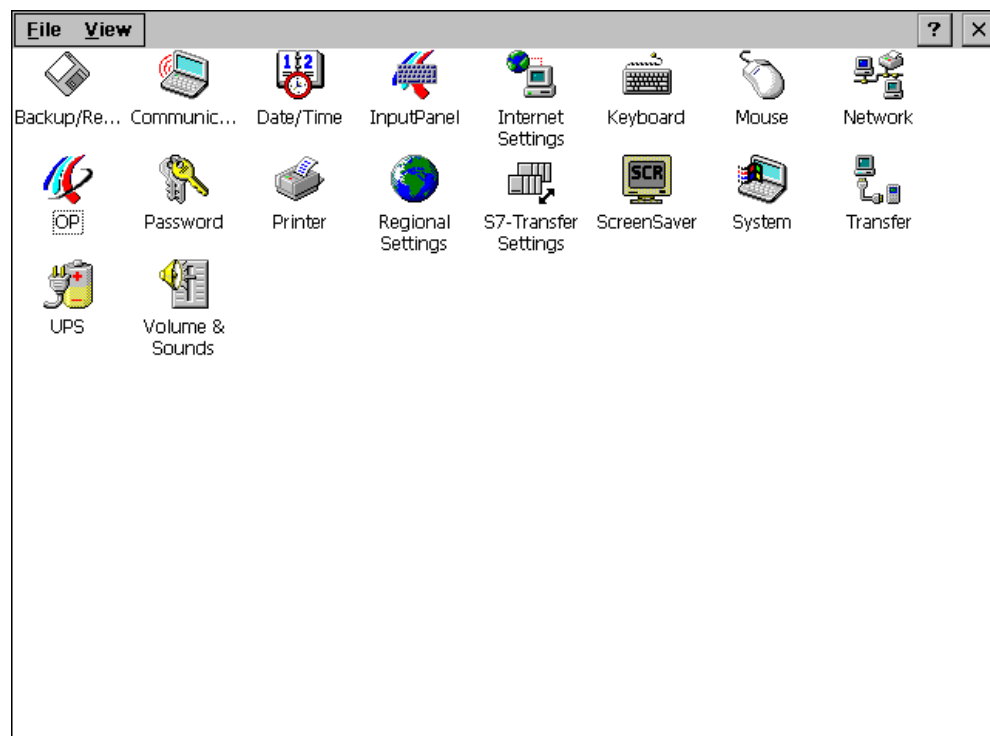

Figure 6-2 Windows CE Control Panel

Change settings



Caution

Stop the runtime software before changing system settings. Otherwise, the changes will not take effect.

Proceed as follows to change settings using the Windows CE Control Panel:

1. Stop the runtime software before modifying any system settings. Use the relevant operating element provided in the project.
2. Open the Control Panel as described above.
3. Change the system settings in the Control Panel.
4. Close the Control Panel:

Touch panel unit:

Press the  button.

Keyboard unit:

Press the  key and use the cursor keys to select the menu command "File > Close".





Confirm the selection by pressing the  key.

5. Start runtime via the loader.

Note

Closing Control Panel dialogs using keyboard devices

Proceed as follows if dialogs, which are open on the HMI device, cannot be closed:

1. Open another dialog in the Control Panel.
 2. Press the key combination  +  to access another open dialog.
 3. Close the dialog by pressing  or .
 4. Repeat steps 2 and 3, as necessary until all the dialogs are closed.
-

6.2.2 Communication

"Communication" option



This function is used to change the name used by the HMI device on the network.

See also

Open Control Panel (Page 6-2)

Configuring the HMI device for network operation (Page 6-19)

6.2.3 Date/time

"Date/time" option



This is used to set the date, time and time zone for the HMI device.

Synchronizing date/time with the PLC

The date and time of the HMI device can be synchronized with the PLC, if this has been configured in the project and the PLC program.. The two PLC jobs 14 ("Set time") and 15 ("Set date") are provided for this.

PLC jobs 40 and 41 can be used to transfer the date and time from the HMI device to the PLC.

Notice

Synchronize the date and time when time-controlled responses should be triggered in the PLC by the HMI device.

The HMI device can only buffer the date and time for a few days if no power is supplied. If the HMI device is not to be used for a number of days, it is recommended to synchronize the date and time via the PLC.

Further information on this is available in the "WinCC flexible Communication" user manual.

See also

Open Control Panel (Page 6-2)



6.2.4 InputPanel

"InputPanel" option



This function defines the position and size of the screen keyboard when it appears on the HMI device.

Procedure

1. Select the "Input Panel" option.
2. Move the screen keyboard to the relevant position.
3. To change the size, press the "Start Resize" button.
4. Store the new settings by pressing the "Save" button.
5. Close the option by pressing the  button or the  key.

Note

In order to store the size and position of the screen keyboard properly and in a fail-safe way, select the alphanumeric representation prior to saving it.

See also

Open Control Panel (Page 6-2)

6.2.5 Network

"Network" option



Network properties are configured here.

See also

Open Control Panel (Page 6-2)

Configuring the HMI device for network operation (Page 6-19)

6.2.6 OP

"OP" option



The following setting options are provided by the "OP" option in the Control Panel:

- Set brightness
- Set contract (for OP 270 and TP 270 only)
- Calibrate touchscreen (for MP 270B Touch and TP 270 only)
- Display device data
- Backup non-resistant data

Set brightness

Note

The MP 270B (TFT display) does not support the "Contrast" function.

1. Open the "Display" tab in the "OP Properties" dialog.

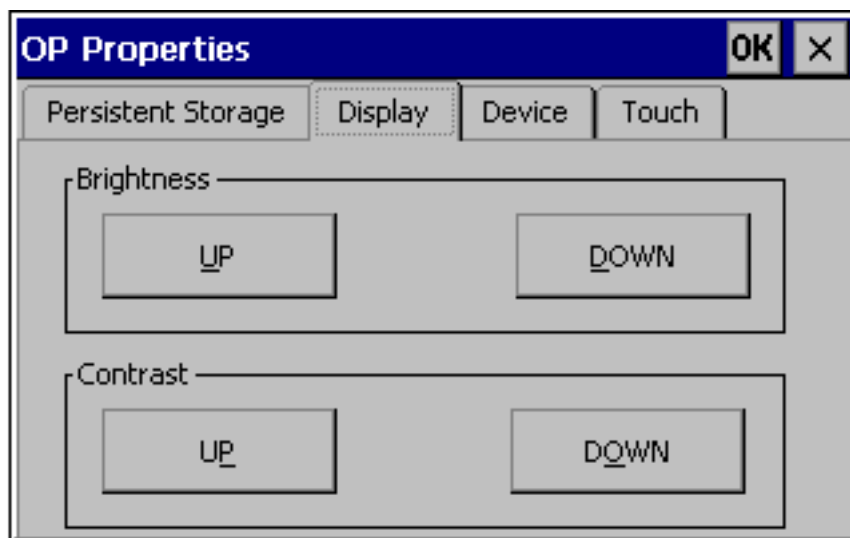







Figure 6-3 "OP Properties" dialog, "Display" tab

2. Change the brightness setting of the screen using the "UP" and "DOWN" buttons in the "Brightness" group.

3. In the case of the touch panel, close the dialog using the "OK" button. In the case of the keyboard unit, move the focus to the tab heading by pressing  and press  to close the dialog.

In the case of keyboard devices, the brightness can be changed outside the Windows CE Control Panel with the following key combinations:



 +  Increases the brightness.

 +  Reduces the brightness.



Note

In the case of the OP 270, the brightness can only be changed minimally according to the display type.

Set contract (for OP 270 and TP 270 only)

1. Open the "Display" tab in the "OP Properties" dialog.
2. Change the contrast setting of the screen using the "UP" and "DOWN" buttons in the "Contrast" group.
3. In the case of the TP 270, close the properties dialog using the "OK" button. In the case of the keyboard unit, move the focus to the tab heading by pressing the  key and the press  key to close the dialog.

The screen contrast on the OP 270 or TP 270 (STN display) can also be adjusted with the following key combinations:

 +  Increases the contrast.

 +  Reduces the contrast.

Note

Wait at least 10 sec. after changing the setting before switching the HMI device off. Otherwise, the changes will not be saved.

Calibrate touchscreen

Depending on the installation position and viewing angle, it is possible that a more or less strong parallax may occur when operating the touch panel screen. In order to prevent resulting operating errors, the screen can be calibrated during the start-up phase and normal operation.

1. Open the "Touch" tab in the "OP Properties" dialog.



Figure 6-4 "OP Properties" dialog, "Touch" tab

2. Press the "Recalibrate" button to start the calibration process.
3. Five calibration crosses appear in succession on the screen. Follow the instructions provided on the screen and touch the respective calibration cross.
4. To apply the new calibration:
Touch any point on the screen after the calibration process for the new calibration data to take effect.
5. To discard the new calibration:
Wait 30 seconds (until the counter reaches zero) before rejecting the new calibration data.
If calibration is not performed correctly, the new values are not accepted.
6. Close the dialog with the "OK" button.

When the "CalibrateTouchScreen" function has been linked to an operating element in the configuration, the touchscreen can be calibrated during normal operation. The operating element can be configured so that a password must be entered to enable the touch calibration process.

The calibration process is identical to steps 3 to 5 described above.

Saving the registration settings or RAM file system

1. Open the "Persistent Storage" tab in the "OP Properties" dialog.

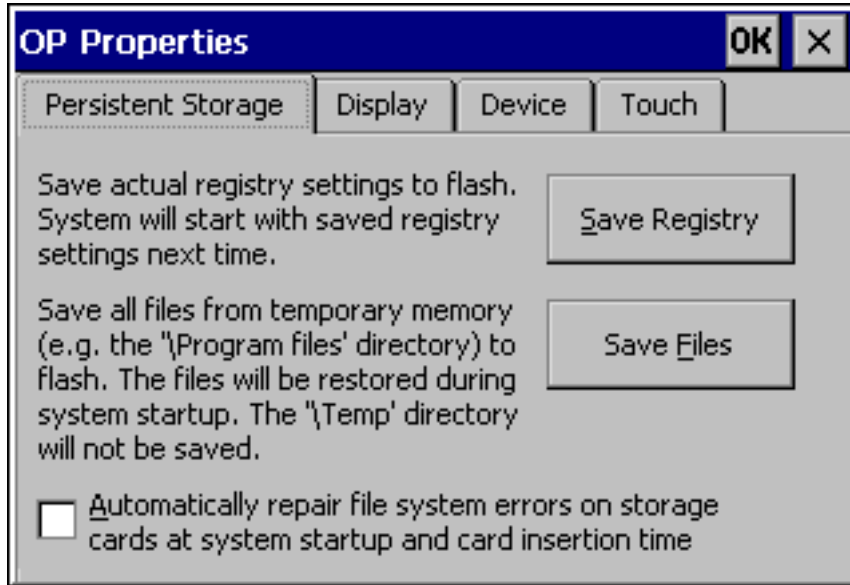

Figure 6-5 "OP Properties" dialog, "Persistent Storage" tab

2. Press the Save Registry button to start the storage process.
The current registration settings are stored in the Flash memory.
3. Press the Save Files button to start copying the files in the RAM file system to the Flash memory.
Following a restart, these saved files will be copied back to the file system.
4. In the case of the touch panel, close the dialog using the "OK" button. In the case of the keyboard unit, move the focus to the tab heading by pressing TAB and press ENTER to close the dialog.

Displaying the HMI device data

1. Open the "Device" tab in the "OP Properties" dialog.
Various device data is displayed.

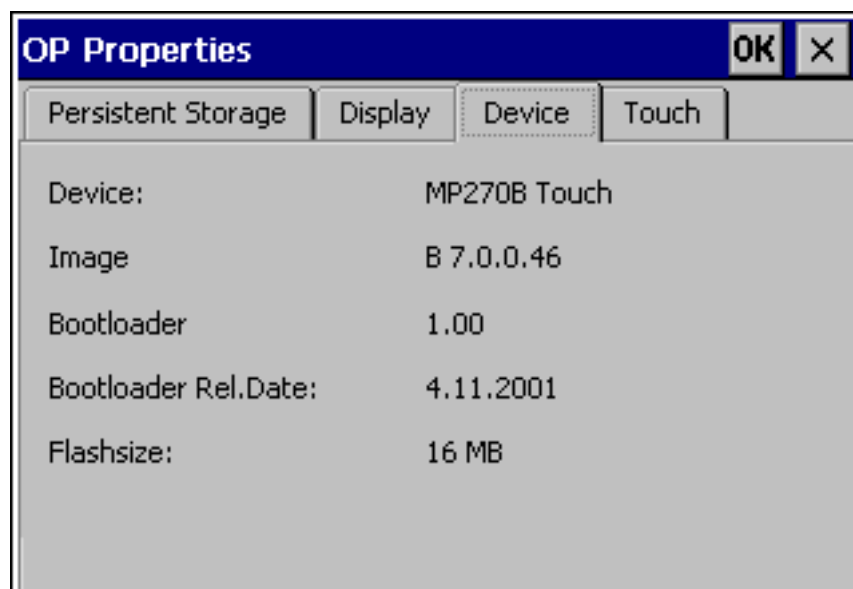



Figure 6-6 "OP Properties" dialog, "Device" tab

2. In the case of the touch panel, close the dialog using the "OK" button. In the case of the keyboard unit, move the focus to the tab heading by pressing  and press  to close the dialog.

See also

Open Control Panel (Page 6-2)

6.2.7 Printer

"Printer" option



A printer can be selected and set up using the "Printer" option. Some settings, e.g. color or quality of graphics printing, are only relevant for printing a hardcopy of the screen contents and have no influence on the alarm logging.

Adjustable options

The available settings depend on the selected printer.

Printer Language

Select the printer from the printer list on the connected HMI device.

Port

Select the port and baud rate used by the HMI device to transfer data to the printer, e.g. IF2: 9600.

Net Path

If a network has been configured, enter a path for a network printer here. Select "Network" as the port.

Paper Size

Select the paper size used in the printer, e.g. A4 or Letter.

Draft Mode

Define the quality of the graphics printout. If the option is activated, printout is performed in draft quality. If deactivated, the printout is in high quality.

Color

Define if a color printer will print in color or black and white.

Orientation

Define whether the page should be printed in Portrait or Landscape,

Note

If a serial printer is connected, the following printer settings are required:

- RS 232, whereby only the RxD, TxD and GND signals are required,
 - 8 data bits
 - 1 stop bit
 - No parity
 - Baud rate between 9600 and 57600, printer-dependent
 - XON / XOFF protocol.
-

Default setting

When the HMI device is supplied, the following default settings are defined:

- Printer: EPSON 9 matrix printer
- Port: IF2
- Baud rate: 9600 bps

See also

Open Control Panel (Page 6-2)

Connect printer (Page 4-10)

Basic principles (Page 6-18)

Interfaces (Page 12-9)

6.2.8 Regional Settings

"Regional Settings" option



Region-specific settings can be defined here. for example:

- Date and time format display
- Displaying numbers

The factory settings on the HMI device are German format.

Note

The settings defined in the "Regional Settings" option do not cause a change of languages in the Windows CE dialogs, e.g. the Control Panel. English is always used.

See also

Open Control Panel (Page 6-2)

6.2.9 Screensaver

"Screensaver" option



It is possible to define a period of time (in minutes) for automatic activation of the screensaver on the HMI device. The screensaver settings are defined in the "Screensaver" option of the Windows CE Control Panels.

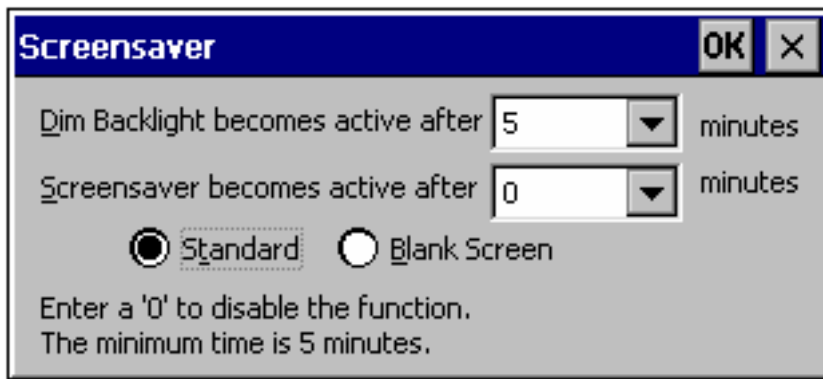

Figure 6-7 "Screensaver" dialog

The screen saver is automatically activated if the HMI device is not operated within the defined period of time.

On entering the value 0, the screensaver is deactivated.

Note

When the screensaver is activated, the back-lighting is automatically dimmed.

The screen saver is deactivated on pressing any key or touching the touchscreen. The function assigned to that key/button is not triggered.

Dim back-lighting

For technical reasons, the brightness of the screen back-lighting is reduced with increased operational use.. To increase the service life of the back-lighting, use the "Screensaver" option in the Windows CE Control Panel to set the period of time after which the back-lighting should be dimmed.

The back-lighting is automatically reduced if the HMI device is not operated within the defined period of time.

On entering the value 0, dimming of the back-lighting is deactivated.

Notice

The screen can still be viewed with a reduced back-lighting.

The back-lighting is reactivated on pressing any key or touching the touchscreen. The function assigned to that key/button is triggered.

See also

Open Control Panel (Page 6-2)

6.2.10 System

"System" option



The "System" option can be used to define the size of the memory for the DRAM file system (storage memory). It defines how much memory can be used by the applications. Values can be modified using a slider control. The standard amount of memory in the DRAM file system for applications is 0.5 MB.

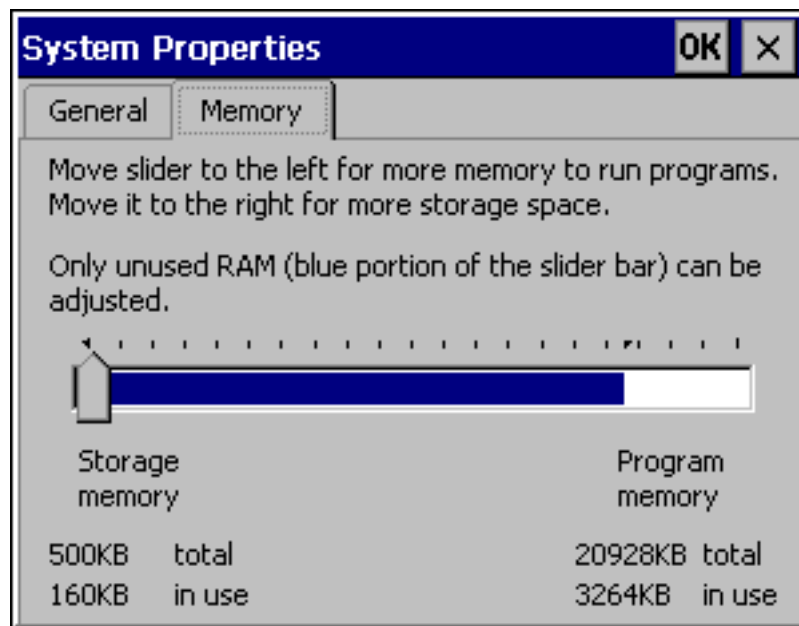

Figure 6-8 "System Properties" dialog



Caution

If too much memory is provided for the DRAM file system, runtime has too little working memory available. Therefore, in the case of incorrect settings, there is no guarantee that the runtime can run properly.



Caution

The operation of runtime together with the Internet Explorer can only be guaranteed when runtime either does not use the Present option or the runtime-capable configuration (*.few) generated is a maximum of 2 NB.

Note

Operation of additional applications together with WinCC flexible

The memory requirements of projects in WinCC flexible has changed in comparison to ProTool.

If user-specific additional applications should be operated on the HMI device together with a WinCC flexible project, the functionality required on the HMI device must be tested and, if necessary, the scope of the project or additional application reduced.

See also

Open Control Panel (Page 6-2)

6.2.11 UPS

Uninterruptible power supply (UPS)

To prevent the loss of data in the event of a power failure (during the logging of process values or alarms, for example), a UPS can ensure a controlled shutdown of the HMI device. An external UPS detects the failure of the power supply and signals this to the HMI device via the serial interface.

The UPS can only be loaded as an option.

"UPS" option



The UPS driver is transferred as an option to the HMI device with WinCC flexible or the ProSave service tool. After transfer, the relevant "UPS" option appears in the Windows CE Control Panel.

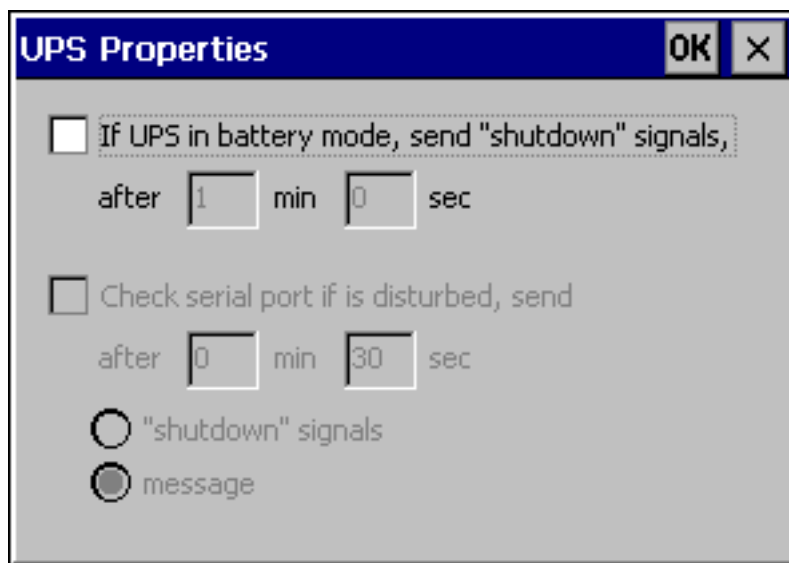

Figure 6-9 "UPS" option

It is possible to define how long the power failure may continue without runtime being stopped. The driver is suitable for the SITOP DC-UPS Module A.

See also

Open Control Panel (Page 6-2)

Transferring options (Page 7-22)

6.2.12 Volume & Sounds

"Volume & Sounds" option



This is used to change the settings for acoustic signals and operating acknowledgement. The "Volume & Sounds" option in the "Volume" tab includes the following options:

- acoustic acknowledgement for touch operation
- volume control

The "Sounds" tab is irrelevant for runtime settings.

See also

Open Control Panel (Page 6-2)

6.3 Network operation

6.3.1 Basic principles

Purpose

The HMI devices can be connected to an Ethernet network. The MP 270B is equipped with an on-board Ethernet interface. In the case of TP 270 or OP 270, an NE2000-compatible PC card is required.

The network function can be used for the following:

- Logging data via the network
- Printing via a network printer
- Storing recipe data records in the network
- Exporting recipe data records from a network
- Importing recipe data records to a network
- Transferring projects
- Backing up data

Notice

The HMI device can only be implemented in TCP/IP networks.

The HMI device only has client functionality in the PC network. This means that users can access files of a subscriber with TCP/IP server functionality from the HMI device via the network. However, it is not possible to access files on the HMI device via the network from a PC.

Note

Information on communication using SIMATIC S7 via Ethernet is provided in the "WinCC flexible Communication" user manual.

Requirements

Within a TCP/IP network, computers are addressed by means of network names. These network names are translated from a DNS or WINS server to TCP/IP addresses. Direct addressing via TCP/IP addresses is not currently supported by the operating system. Therefore, to ensure the functionality of the HMI device in a TCP/IP network, it is useful to employ a DNS or WINS server. Appropriate servers are available in common TCP/IP networks. Please contact your network administrator.

Printing via a network printer

The HMI device's operating system does not support the direct alarm logging via a network printer. All other printer functions such as hardcopy or shift log, are possible via the network without restriction.

6.3.2 Configuring the HMI device for network operation

Overview

The HMI device must be appropriately configured before setting into network operation. The configuration is basically divided into the following steps:

- Set computer name of the HMI device
- Configure the network address.
- Set login information
- Save settings

Preparations

Before beginning the configuration, request the specific network parameters from the network administrator. The following information is of particular interest:

- Does the network use DHCP for dynamic assignment of network addresses? If not, get a new TCP/IP network address for the HMI device.
- What is the TCP/IP address of the default gateway?
- What are the DNS addresses of the name server?
(If DNS is used in the network)
- Which WINS addresses has the name server?
(If WINS is used in the network)

Procedure

The following instructions describe how to define the general settings. Additional steps or procedures may be necessary depending on the network infrastructure.

1. Open the Control Panel.
2. Set computer name of the HMI device.

In order to identify the HMI device within the network, it must be assigned a unique name (device name) within the network using the Control Panel option "Communication"



Apply the settings and close the dialog by pressing <ENTER>.

3. Configure the network address.



- Use the "Network" option to open the network configuration.
- Select an appropriate network driver in the "Adapters" tab.
Select "Onboard LAN" for HMI devices with an integrated Ethernet card. Select NE2000-compatible driver for other network cards.
- Press the "Properties" button in order to configure the network characteristics of the network card used.

Complete the dialog according to the network driver selected.

- If your network uses DHCP, skip this step.
Select the "IP Address" tab then the "Specify an IP Address" option.
Enter the TCP/IP address of the HMI devices (e.g. 233.239.2.100), subnet mask (e.g. 255.255.255.0) and default gateway (e.g. 223.239.2.200).
- Enter the name server address of the network in the "Name Servers" tab.
Close the dialog with <ENTER> or press "OK" to apply the settings.

4. Set login information.

In order to correctly log on to the network, enter your user permissions in the "Identification" tab. Enter the user name valid for the network or the network server and the associated password (max. 8 characters).

If the network administrates users via domain controllers, enter the relevant domain controller name.

Close the dialog with <ENTER> or press "OK" to apply the settings.

5. Save the settings.

- Switch off the HMI device.
- Before switching the HMI device on, insert the network cable in the corresponding interface so that a unique IP address can be assigned during the start-up phase.
- Switch the HMI device on again.

See also

Open Control Panel (Page 6-2)



6.3.3 Test network

Procedure

When the HMI device has been configured for network operation, connect the network server via Windows Explorer to test the network. Proceed as follows:

1. Start Windows Explorer via the Windows CE Start menu.

- Keyboard unit:

The Windows CE Start menu can be opened by pressing the key combination  + .

- Touch panel unit:

- The Windows CE Start menu can be opened by pressing the  button twice (locking key) on the alphanumeric screen keyboard.

Select the "Windows Explorer" application from the "Programs" program group.

2. Use the "Address" input field to enter the UNC name of the folder or drive provided on the server.

Example:

The server is called: mnrnbg2

The name provided is: data

The resulting UNC name is: \\mnrnbg2\data

Note

The use of TCP/IP addresses to address PCs is not supported by the operating system.

For example, the use of the UNC names "\\130.170.10.45\data" is not permitted.

3. After entering the UNC name, press the <ENTER> key.

Result

When all the network settings are correct, Windows Explorer displays the files located under the directory provided on the TCP/IP server.

Note

In addition, the network program "ipconfig" is available in the operating system.

See also

Configuring the HMI device for network operation (Page 6-19)

6.3.4 Configuring network access

Requirements

The network is set up on the HMI device.

Procedure

In order to use the network functions in the WinCC flexible configuration software, specify the relevant UNC assigned names at those points where paths have been entered for files or directories.

Example 1: Logs

If you want to perform logging on the server in the example above, replace the predefined archive memory location "\\Storage Card\Logs" with the UNC assigned name for the server, e.g. "\\mnrnbg2\data\logs".

Example 2: Recipe data records

In order to store recipe data records in the network, replace the predefined path name "\\Flash\Recipes" with the UNC assigned name for the server, i.e. "\\mnrnbg2\data\recipes". The same applies for exporting and importing recipe data records using the functions "ExportDataRecords" and "ImportDataRecords". In this case, replace the parameter "File name" with the UNC assigned name for the server.

See also

Configuring the HMI device for network operation (Page 6-19)

Test network (Page 6-21)

Prepare and backup project

7.1 Transfer project to the HMI device

7.1.1 Commissioning for the first time

Introduction

There is no configuration on the HMI device when commissioning for the first time. In order to transfer the necessary project data and the runtime software from the configuration computer to the HMI device, proceed as follows, observing the sequence.

Notice

When starting the first time, observe the safety information on reverse poling.

Caution

Always terminate the runtime software before switching off the voltage supply in order to prevent loss of data.

Press the operating element linked to the "StopRuntime" system function in the project to stop runtime. Wait until the HMI device displays the loader and then switch off the power supply.

Note

During the commissioning phase, it is possible to connect an external USB keyboard or mouse via the USB interface.

Procedure

1. Connect the HMI device to the configuration computer using a suitable standard cable. Use one of the following interfaces depending on the type of transfer:

- IF2 (serial)
- IF1B (MPI/PROFIBUS DP)
- USB
- Ethernet

Transfer via modem is also possible.

Default setting: Serial connection

2. Switch on the power supply to the HMI device.

When starting the HMI device, the system automatically switches from the loader to the Transfer menu.

3. Press the "Cancel" button to switch to the loader.
4. Press the "Control Panel" button to switch to the Windows CE Control Panel.
5. Adapt the interface setting (serial, MPI, USB or Ethernet) in the transfer settings.

Default setting: Serial connection

6. Close the Control Panel and switch to the transfer mode.

7. Start transfer of the project on the configuration computer. Please refer to the "WinCC flexible" user manual for more information on the necessary settings on the configuration computer.

Result

The configuration computer checks the connection to the HMI device. If the connection is not available or defective, the configuration computer issues the corresponding error message.

If transfer from the configuration computer is terminated as a result of a compatibility conflict, the HMI device's operating system must be updated.

If the connection is correct, the new configuration is transferred to the HMI device. Following successful transfer, the project is started and the start screen of the transferred project appears.

Set date/time

The date and time must be updated in the following cases:

- Initial startup
- If the HMI device is disconnected from the power supply for an extended period without a backup battery

See also

Update operating system (Page 7-18)

HMI device loader (Page 6-1)

7.1.2 Recommissioning

Purpose

When recommissioning, the existing configuration on the HMI device is replaced by another. For this to occur, a new project must be transferred from the configuration computer to the HMI device.

Instructions for transferring a project from the configuration computer to the HMI device can be found in the "Transfer" section.

The following options are available for switching the HMI device to transfer mode:

- Start transfer mode manually during the HMI device startup phase.
- When the HMI device is in normal operation, start a manual transfer by pressing the corresponding operating element in the project.
- Start transfer mode manually with the HMI device in normal operation

7.2 Transfer

7.2.1 Start transfer manually

Procedure

1. Connect the HMI device to the configuration computer using a suitable standard cable. Use one of the following interfaces depending on the type of transfer:
 - IF2 (serial)
 - IF1B (MPI/PROFIBUS DP)
 - USB
 - EthernetTransfer via modem is also possible.
2. Switch on the power supply to the HMI device.
3. Adapt the interface setting (serial, MPI, USB or Ethernet) in the transfer settings.
4. Close the Control Panel and switch to the transfer mode.
5. Start project transfer on the configuration computer.

Result

The configuration computer checks the connection to the HMI device. If the connection is not available or defective, the configuration computer issues the corresponding error message.

If downloading from the configuration computer is terminated as a result of a compatibility conflict, the HMI device's operating system must be updated.

If the connection is correct, the new project is transferred to the HMI device. Following successful transfer, the project is started and the start screen of the transferred project appears.

7.2.2 Start transfer automatically

Overview

The HMI device can automatically switch to transfer mode during runtime when a transfer is started on the connected configuration computer. Transfer is completed without intervention on the HMI device. Therefore, this option is particularly recommended for the test phase of a new project.

To switch to transfer mode from normal operation, open the "Transfer Settings" window on the HMI device and activate the required connection and the corresponding "Remote Control" function.

Notice

When the "Remote Control" option is active, runtime automatically shuts down and switches to transfer mode. Shutdown is not possible when dialogs are open or a transfer has been started on the HMI device.

Close the dialog or cancel the transfer process on the configuration computer.

Following the start-up phase, disable the automatic transfer option. This will prevent inadvertently switching the HMI device to transfer mode, stopping runtime. To do this, deactivate the "Remote Control" options in the Transfer Settings defined for the HMI device.

7.2.3 Transfer mode options

Transfer mode options



The following options can be set for transfer mode:

- The HMI device can be switched to transfer mode automatically when in normal operation as soon as a transfer is started on the connected configuration computer.
- Select a specific connection type so that transfer can only occur either via a serial connection, MPI/PROFIBUS-DP, USB or Ethernet connection.

Note

Do not make any other changes when runtime is running or when the HMI device is in transfer mode.

Setting the communication channel

The "Channel" tab in the Transfer Settings menu can be used to activate the required communication channel and the "Remote Control" checkbox. In addition to the serial communication channel, a second channel can also be selected to transfer data from the configuration computer to the HMI device.

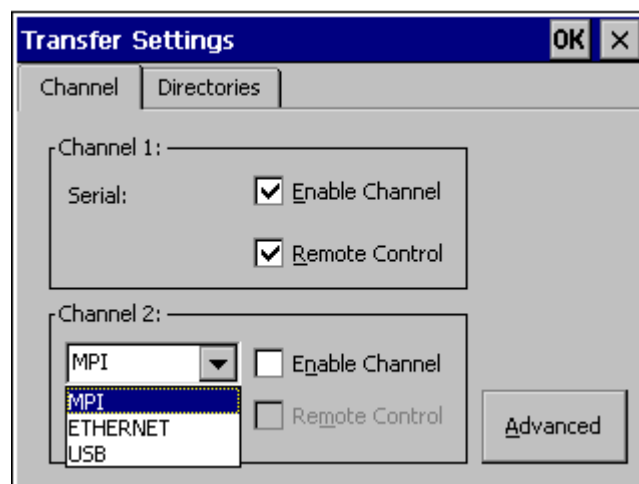

Figure 7-1 "Transfer Settings" dialog, "Channel" tab

Press the "Advanced" button to define the following settings:

- For transfer MPI or PROFIBUS-DP, define the "Address" bus parameter and "Transmission Rate" and "Highest Station" network parameters.
- Define the driver for transfer via Ethernet.



Warning

When the "Remote Control" checkbox is active, ensure that the HMI device is not inadvertently switched to transfer mode from the configuration computer.

In the case of PROFIBUS DP, changes may only be made here for commissioning purposes.

Following each modification of the PROFIBUS DP settings, the HMI devices only set one corresponding standard bus parameter set. In unfavorable conditions, this can lead to faults on the PROFIBUS.

In order to calculate the bus parameters exactly, the entire bus topology must be known.

Correct definition of the bus parameters for runtime is automatically ensured by the integrated operation of WinCC flexible in SIMATIC STEP 7.

Notice

If a serial printer is connected to the HMI device, deactivate it by selecting "Remote Control" checkbox for the serial communication channel. Otherwise, printing is not possible.

When a configuration is transferred from the configuration computer to the HMI device, enable a communication channel using the "Enable Channel" option.

If an interface is occupied by other programs, transfer cannot take place via that interface.

Note

The bus parameters for the MPI transfer, e.g. MPI address, baud rate, etc., are read from the project currently loaded on the HMI device.

The settings for MPI transfer can be modified. To do this, stop the runtime, modify the settings and switch to transfer mode. When runtime is subsequently started, the bus parameters are overwritten by values from the project.

Transfer mode directories

The "Directories" tab can be used to specify the following paths (refer to figure below).

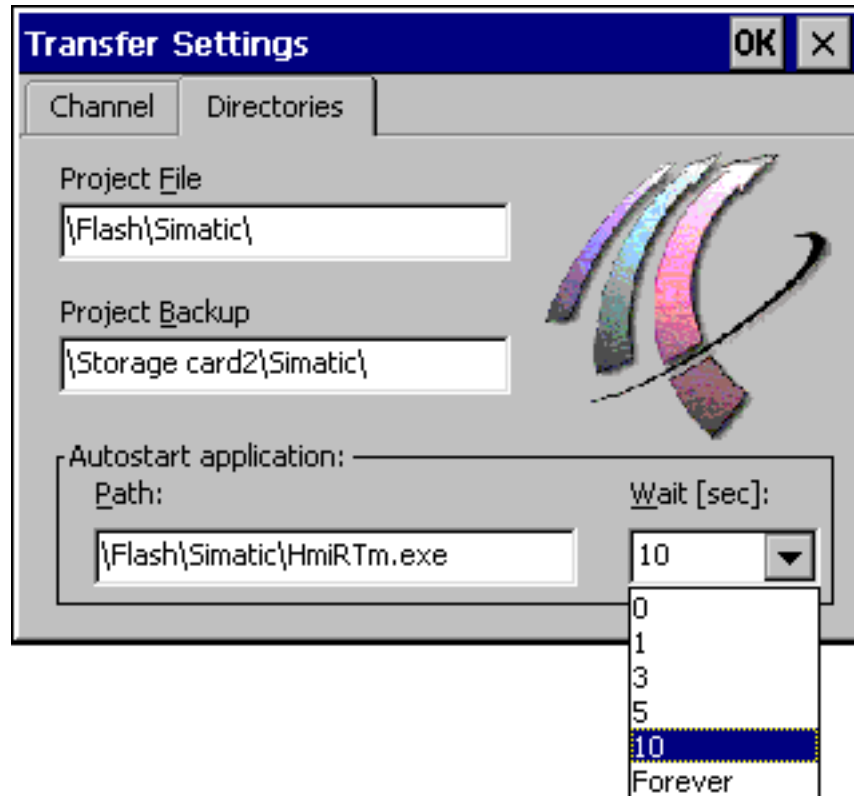

Figure 7-2 "Transfer Settings" dialog, "Directories" tab

Project File

The predefined storage location for the project file can be changed here. The internal Flash memory or external Flash cards can be set. During the next transfer process, the project is stored in the storage location specified.

Project backup

The predefined storage location for your project source file can be changed here. This file can be used for restoring (uploading) the configuration. External Flash cards or network connections can be set.

Autostart application

- **Path**

The memory location for runtime is defined here. This is the application where the project runs under Windows CE.

- **Wait**

It is possible to define the number of seconds the loader should remain on screen before the runtime is started (1 s, 3 s, 5 s, 10 s or constantly). If no runtime software is available, the device automatically switches to transfer mode.

Notice

With the exception of the "Wait" field, do not change default settings in the fields when working with WinCC flexible. Otherwise, the HMI device can no longer start the project.

Press the "OK" button or <ENTER> key to confirm the settings currently defined for the transfer options. Ensure that no buttons have been selected. The dialog is closed and the Windows CE Control Panel is displayed.

Press the close symbol or <ESC> key to close the dialog and open the Windows CE Control Panel. Any modifications made to the settings are rejected.

Note

If the HMI device is in transfer mode while changes are made to the transfer settings, the settings only take effect after the transfer function is restarted. This can occur when the Control Panel is selected via the Windows Start menu in order to modify the transfer properties.

7.2.4 Test project

Introduction

There are three ways to test a new project:

- Test the project on the configuration computer
- Test project offline
- Test project online

Test the project first on the configuration computer using the simulator. Then, always test the project online.

The material supplied with WinCC flexible contains a simulation program which can be used to test the project on the configuration computer without the necessity of connecting a PLC or HMI device. Detailed information on this is available in the "WinCC flexible" user manual and in the WinCC flexible online help.

Test the following objects:

1. Check that configured screens are displayed correctly.
2. Check the screen hierarchy.
3. Test input objects.
4. Test softkeys.
5. Test that tag data can be entered.

The tests increase the certainty that the project will run error-free on the HMI device.

Conditions for the offline test

- The project is located on the HMI device.
- The project is set "Online: off"

Open the selected project on the configuration computer. Select the "Communication > Connections" options and set "Online: Off." Transfer the project to the HMI device. The operating mode can also be changed by an operating element in the project.

- The project has an operating element for switching operating modes

Use the operating element to switch the project offline.

Note

During the test phase, it is recommended to enable switching to transfer mode from normal operation.

Procedure

After setting the HMI device "offline", the individual project functions can be tested on the HMI device without the functions being affected by the PLC. The PLC tags are not updated in offline mode.

Proceed as follows:

1. Check that configured object are displayed correctly.
2. Check the screen hierarchy.
3. Check input fields.
4. Test softkeys.

Conditions for the online test

- The project is located on the HMI device.
- The HMI device is connected to a PLC.

Procedure

Proceed as follows:

1. Set the HMI device to "online"
2. Test all the items in the loaded project for which communication with the PLC is necessary:
 - Alarms
 - Alarm logging
 - Screen selection by PLC through PLC job
 - Print functions

7.2.5 Uploading project

Introduction

During transfer, generally only the run-capable configuration (*.fwx) is transferred to the HMI device. If the original project file is to be used for further development of the configuration or for fault analysis, it must remain on the configuration computer.

The project and associated source file (*) can be stored on the HMI device. It can be retrieved (transferred back) if necessary.

After uploading a project, it can be analyzed and modified. This is of particular importance if

- the original configuration computer cannot be accessed, or
- the project source file is no longer available.

Requirements

The following conditions must be fulfilled in order to retrieve a project:

- The HMI device is connected to a configuration computer.
- The associated source file is stored on the HMI device.
- The "Enable Upload" option must be selected in order for the project file to be transferred from the configuration computer to the HMI device.

This option can be activated in WinCC flexible in "Project > Transfer > Transfer Settings".

- A memory card is inserted in the HMI device.

Downloading and uploading

In the case of transfer, including transfer of the source file, the project file is transferred to the HMI device.

Following uploading onto the configuration computer, the *.pdz file is compressed by the WinCC flexible configuration software. The project is then available in HMI format on the configuration computer and can be edited.

Notice

Version number

The uploaded project file can only be opened with a configuration software whose version number is greater than or equal to that of the configuration software used to create the project.

Test source file

WinCC cannot determine if the source file on the HMI device was generated from the project run on it. If a transfer is performed at any time without the "Upload" option activated, only the project is transferred. The existing source file may be from a previously transferred project.

Procedure

1. Select the menu options "Project > Transfer > Communication Settings" on the configuration computer in WinCC flexible.
The "Communication Settings" dialog box is opened.
2. Select the required HMI device type and connection type between the HMI device and the configuration computer.
3. Define the connection parameters.
4. Select "OK".
5. Switch the HMI device to transfer mode in the loader.
6. On the configuration computer, use WinCC to start the back transfer using the "Project > Transfer > Back Transfer" menu options.
The project is opened on the configuration computer.

Result

The uploaded project is opened on the configuration computer. Save the project, if necessary.

7.3 System settings

7.3.1 Set language

Language-dependent objects

When transferring the project from the configuration computer, up to five languages can be loaded on the HMI device simultaneously. The Asian language variants are also supported. If properly configured, it is possible to switch between the individual languages online at any time. You can also display language-dependent objects in another language during runtime, if properly configured.

The following are language-dependent:

- Alarms
- Screens
- Text lists
- Help texts
- Date/time
- Decimal symbol
- Static texts

Requirements

If you wish to change the language for project texts on the HMI device, the following conditions must be met:

- The language must be available for the configuration on the HMI device.
The languages available on the HMI device are defined during configuration.
- An operating element to switch languages must have been configured.

Select languages

Immediately after activating the operating element to change languages, all the language-dependent objects are displayed in the new language.

Two different types of language change can be configured:

1. Each time the operating element to change languages is actuated, the HMI device switches to the next language in sequence.
2. After pressing the operating element to change languages, a specific language is selected.

7.3.2 Set operating mode

Conditions for changing operating modes

In order to switch the HMI device between the operating modes described below, the relevant function must be linked to an operating element in the configuration.

Operating modes

The HMI device is designed for the following operating modes:

- Offline mode
- Online mode
- Transfer mode

The operating modes "Offline" and "Online" can be adjusted in the system and can be executed by means of a configured object. The function of transfer mode can only be configured as an operating element.

Offline mode

In this mode, there is no communication connection between the HMI device and PLC. The HMI device can be operated but data cannot be downloaded or received by the PLC.

Online mode

In this mode, a communication connection between the HMI device and PLC exists. When using this mode, processes in progress can be operated and visualized without restriction.

Transfer mode

This operating mode is used to transfer a project from the configuration computer to the HMI device.

7.4 Other transfer functions

7.4.1 Functions

ProSave Service Tool

The ProSave Service Tool is supplied with WinCC flexible. ProSave provides all the necessary functions to transfer data between the configuration computer and HMI device. These include:

- Saving data (backup)
- Retrieving data (restore)
- Updating the operating system (OS update)
- Transferring authorizations
- Transferring options

ProSave can operate together with WinCC flexible or as a standalone tool on the configuration computer. Further information on ProSave is available in the "WinCC flexible" user's guide.

ProSave functions in WinCC flexible

ProSave is normally installed on the configuration computer together with WinCC flexible.

The entire function range of ProSave is available within WinCC flexible in the "Project > Transfer" menu. In this way, all the necessary specifications, e.g. target device and download settings, are assumed from the project.

Standalone ProSave

ProSave can also be installed as a standalone application. In this case, the settings relating to the HMI device and the transfer must be defined in the ProSave user interface and match the HMI device settings.

The advantage of standalone ProSave is that backup and restore can be performed without WinCC flexible via the following transfer channels:

- Serial
- MPI/PROFIBUS DP
- USB
- Ethernet

7.4.2 Backup and Restore

Introduction

Using WinCC flexible or the ProSave Service Tool, it is possible to backup and restore projects, recipes and passwords.

If the service tool was installed with WinCC flexible, it can be opened on the configuration computer with the command "SIMATIC > ProSave" in the "Start" menu.

ProSave is an executable program which can run without WinCC flexible. ProSave can, thus, be run without a WinCC flexible license.

Requirements

- The HMI device is connected to a configuration computer.
- WinCC flexible or ProSave must have been installed on the configuration computer.

Notice

Close all open applications on the configuration computer before starting Backup or Restore.

Backup

During the backup process, the project is transferred from the HMI device Flash memory to the configuration computer.

There are two ways to make a backup copy:

- Backup using standalone ProSave
- Backup using WinCC flexible

Notice

Licenses on the HMI device are not saved in this case.

The procedure for the backup differs in terms of the operations performed on the configuration computer.

Procedure - backup using standalone ProSave

1. Start ProSave on the configuration computer using the Windows Start menu.
2. Use the "General" tab register to select the required HMI device and connection type with corresponding connection parameters.
3. Use the "Backup" tab to select the data to be saved:
 - "Recipes" or
 - "Passwords" or
 - Complete backup
4. Select the folder in which the *.psb backup file should be saved.
5. Configure the necessary transfer channel on the HMI device.
6. Switch the HMI device to transfer mode.
7. Start the Backup process in ProSave by using the "Start Backup" button.
A status display monitors the progress of the data transfer.

Procedure - backup using WinCC flexible

1. Use "Project > Transfer > Transfer Settings" in the WinCC flexible "Select HMI devices for transfer" dialog to select the corresponding connection type with related connection parameters.
2. Open the "Backup Settings" dialog in WinCC flexible using the menu commands "Project > Transfer > Backup".
3. Select the data to be saved:
 - "Recipes" or
 - "Passwords" or
 - "Complete Backup"
4. Select the folder in which the *.psb backup file should be saved.
5. Configure the necessary transfer channel on the HMI device.
6. Switch the HMI device to transfer mode.
7. Start the backup process in WinCC flexible using the "OK" button.
A status display monitors the progress of the data transfer.

Result

When the transfer is successfully completed, a message appears. The project is copied on the configuration computer.

Restore

In the case of a restore process, the data backup stored on the configuration computer is reloaded into the internal Flash memory of the HMI device.

There are two ways to restore the data:

- Restore using standalone ProSave
- Restore using WinCC flexible

Notice

Data loss

The files in the user memory of the HMI device are deleted during this process. This also applies to the licenses on the HMI device. Therefore, save the licenses elsewhere before starting the restore process.

The restore procedure differs in terms of the operations performed on the configuration computer.

Procedure - restore using standalone ProSave

1. Start ProSave on the configuration computer using the Windows Start menu.
2. Use the "General" tab register to select the required HMI device and connection type with corresponding connection parameters.
3. Select the path in the "Restore" tab which contains the file to be restored.
"Content" indicates the HMI device for which the backup was produced and the type of backup data contained in the file.
4. Configure the necessary transfer channel on the HMI device.
5. Switch the HMI device to transfer mode.
6. Start the restore process in ProSave by using the "Start Restore" button.
A status display monitors the progress of the restore process.

Procedure - restore using WinCC flexible

1. Use "Project > Transfer > Transfer Settings" in the WinCC flexible "Select HMI devices for transfer" dialog to select the corresponding connection type with related connection parameters.
2. Open the "Restore Settings" dialog in WinCC flexible using the menu commands "Project > Transfer > Restore".
3. Select the path in the "Open" field which contains the file to be restored.
"Content" indicates the HMI device for which the backup was produced and the type of backup data contained in the file.
4. Configure the necessary transfer channel on the HMI device.
5. Switch the HMI device to transfer mode.
6. Start the backup process in WinCC flexible using the "OK" button.
A status display monitors the progress of the restore process.

Result

When the transfer is successfully completed, a message appears. The project is available on the HMI device again.

7.4.3 Update operating system

Introduction

Conflicts may occur when using the HMI device due to different versions of the configuration software used and the image which exists on the HMI device. In such a case, transfer of the project is stopped by the configuration computer and a message indicating a compatibility conflict appears. The operating system on the HMI device must then be updated. For this purpose, a current HMI device image must be transferred to the HMI device. The image contains the necessary operating system.

The procedure is described below.

Requirements

- The HMI device is connected to the configuration computer according to the selected connection type.
- WinCC flexible or ProSave is installed on the configuration computer.

Notice

Data loss

When the operating system is updated, all the existing data such as project, applications, passwords and recipes is deleted from the HMI device.

There are two different procedures for updating the operating system:

- Updating the operating system using standalone ProSave
- Updating the operating system using WinCC flexible

If an operating system update should be performed using WinCC flexible, all the general settings, such as HMI device and transfer settings, are assumed from the project.

Update operating system

There are two types of operating system updates:

- An update on an HMI device on which an operating system already exists
In this case, the operating system update can be executed without activating the "Booting" checkbox.

- An update on an HMI device on which there is no operating system

In this case, the operating system update can be executed with the "Booting" checkbox activated.

Procedure – update operating system without Booting

When updating the operating system without "Booting", the configuration computer communicates with the HMI device via its operating system.

Proceed as follows in order to adapt the operating system on the HMI device to the configuration software version used:

1. Start WinCC flexible via the Windows Start menu on the configuration computer and open a project, or start ProSave via the Windows Start menu.
2. In WinCC flexible, select the menu options "Project > Transfer > Transfer Settings" or select the HMI device available on the "General" tab in ProSave.
3. Select the connection.
4. Enter the connection parameters.
5. In WinCC flexible, select the menu options "Project > Transfer > Update Operating System" or select the "OS Update" tab in ProSave.
6. Deactivate the "Booting" checkbox if it is activated.
7. In "Image path", select the directory which contains the image file belonging to the HMI device (file extension *.img).
8. Select the "Open" button.

When the image file has been opened successfully, various version information appears in a window.

9. Configure the necessary transfer channel on the HMI device.
10. Switch the HMI device to transfer mode.
11. Start the operating system update on the configuration computer by using the "Update OS" button.

The time this process takes differs depending on the data channel selected. A status display will monitor the transfer's progress.

Result

When the operating system update is successfully completed, a message appears.

There is no longer a project on the HMI device.

Procedure – update operating system with Booting

When updating the operating system with "Booting", the configuration computer communicates with the HMI device via the boot loader.

Connect the HMI device to the configuration computer.

Notice

An operating system update with "Booting" is only possible via the serial connection.

After starting the operating system update, the HMI device must be rebooted so that the HMI device establishes contact via the serial interface.

Proceed as follows in order to adapt the operating system on the HMI device to the configuration software version used:

1. Switch off the power supply to the HMI device.
2. In WinCC flexible on the configuration computer, select the menu options "Project > Transfer > Transfer Settings" or select the HMI device available on the "General" tab in ProSave.
3. Select the connection.
4. Enter the connection parameters.
5. In WinCC flexible, select the menu options "Project > Transfer > Update Operating System" or select the "OS Update" tab in ProSave.
6. Activate the "Booting" checkbox if it is deactivated.
7. In "Image path", select the directory which contains the image file belonging to the HMI device (file extension *.img).
8. Select the "Open" button.
When the image file has been opened successfully, various version information appears in a window.
9. Start the operating system update by using the "Update OS" button.
10. Reconnect the power supply to the HMI device.

This starts the update. The time this process takes differs depending on the data channel selected. A status display will monitor the transfer's progress.

Result

When the operating system update is successfully completed, a message appears.

There is no longer a project on the HMI device.

7.4.4 Transferring authorizations

Introduction

To protect the software, licenses (authorizations) on an Authorization disk can be transferred to and transferred back from the HMI device.

The authorization disk is supplied with the respective option, with ProAgent/MP for example, with ProAgent/MP for example.

Requirements

- The HMI device is connected to the configuration computer according to the selected connection type.
- WinCC flexible or ProSave is installed on the configuration computer.
- Insert the Authorization disk containing the licenses to be transferred in the disk drive of the configuration computer.

The ProSave Service Tool can be used to transfer authorizations. An advantage of this is that the authorization can be transferred without calling in WinCC flexible.

There are two methods of transferring an authorization:

- Transferring an authorization using standalone ProSave
- Transferring an authorization using WinCC flexible

If an authorization transfer should be performed using WinCC flexible, all the general settings, such as HMI device and transfer settings, are assumed from the project.

Procedure - transferring an authorization to the HMI device

Transferring an authorization to the HMI device

1. Start WinCC flexible via the Windows Start menu on the configuration computer and open a project, or start ProSave via the Windows Start menu.
2. In WinCC flexible, select the menu options "Project > Transfer > Transfer Settings" or select the HMI device available on the "General" tab in ProSave.
3. Select the connection.
4. Enter the connection parameters.
5. Select the menu options "Project > Transfer > Authorizations" in WinCC flexible or select the "Authorize" tab in ProSave.
6. Select the authorization to be transferred to the HMI device from the "Choices" options.
7. Configure the necessary transfer channel on the HMI device.
8. Switch the HMI device to transfer mode.
9. Press the ">>" button to start transferring the authorization onto the configuration computer.

Result

The authorization is transferred to the HMI device. The option as to which authorization is required can now be defined on the HMI device.

Procedure - transferring authorization back from the HMI device

Transferring an option back from the HMI device:

1. Start WinCC flexible via the Windows Start menu on the configuration computer and open a project, or start ProSave via the Windows Start menu.
2. In WinCC flexible, select the menu options "Project > Transfer > Transfer Settings" or select the HMI device available on the "General" tab in ProSave.
3. Select the connection.
4. Enter the connection parameters.
5. Select the menu options "Project > Transfer > Authorizations" in WinCC flexible or select the "Authorize" tab in ProSave.
6. Configure the necessary transfer channel on the HMI device.
7. Switch the HMI device to transfer mode.
8. Press the "Device Status" button on the configuration computer to display all the authorizations currently installed on the HMI device.
9. Select the authorizations under "Installed Authorizations" to be transferred from the HMI device.
10. Press the "<<" button to start transferring the authorizations back.

Result

The authorization is transferred back from the HMI device. The option as to which authorization is required can no longer be used on the HMI device.

7.4.5 Transferring options

Introduction

Options specially developed for the HMI device, e.g. additional applications, can be installed on the HMI device.

ProSave is supplied with the following options by default:

- Drivers for uninterruptible power supply
- Pocket Internet Explorer

Requirements

- The HMI device is connected to the configuration computer according to the selected connection type.
- WinCC flexible or ProSave is installed on the configuration computer.

The ProSave Service Tool can be used to transfer authorizations. An advantage of this is that the option can be transferred without calling in WinCC flexible.

There are two methods of transferring an option:

- Transferring an option using standalone ProSave
- Transferring an option using WinCC flexible

If an option transfer should be performed using WinCC flexible, all the general settings, such as HMI device and transfer settings, are assumed from the project.

Procedure - transferring an option to the HMI device

Transferring an option to the HMI device

1. Start WinCC flexible via the Windows Start menu and open a project, or start ProSave via the Windows Start menu.
2. In WinCC flexible, select the menu options "Project > Transfer > Transfer Settings" or select the HMI device available on the "General" tab in ProSave.
3. Select the connection.
4. Enter the connection parameters.
5. Select the menu options "Project > Transfer > Options" in WinCC flexible or select the "Options" tab in ProSave.
6. Select the options to be transferred to the HMI device from "Available options".
7. Configure the necessary transfer channel on the HMI device.
8. Switch the HMI device to transfer mode.
9. Press the ">>" button to start transferring the option.

Result

The option is transferred to the HMI device.

Procedure - transferring authorization back from the HMI device

Transferring an option back from the HMI device:

1. Start WinCC flexible via the Windows Start menu on the configuration computer and open a project, or start ProSave via the Windows Start menu.
2. In WinCC flexible, select the menu options "Project > Transfer > Transfer Settings" or select the HMI device available on the "General" tab in ProSave.
3. Select the connection.
4. Enter the connection parameters.

5. Select the menu options "Project > Transfer > Options" in WinCC flexible or select the "Options" tab in ProSave.
6. Configure the necessary transfer channel on the HMI device.
7. Switch the HMI device to transfer mode.
8. Press the "Device Status" button on the configuration computer to display all the options currently installed on the HMI device.
9. Select the options under "Installed Options" to be transferred back from the HMI device
10. Press the "<<" button to start transferring the options back.

Result

The option is transferred back from the HMI device.

See also

UPS (Page 6-16)

Runtime functionalities of a project

8.1 Screen objects

Overview

Runtime offers the following objects for operating and monitoring:

- Button
- Switch
- I/O field
- Graphic I/O field
- Symbolic I/O field
- Alarm indicator
- Alarm view
- Alarm window
- Recipe view
- Bar
- Trend view
- Slider control
- Gauge
- Date / time field
- Clock
- User view
- Status force
- Sm@rtClient view
- Symbol library

8.2 Alarms

Alarm classes

Alarms indicate events and states in the control process on the HMI device. WinCC flexible distinguishes the following alarm classes:

- Operation

Warning alarms indicate a process status, e.g. motor is ON. Warning alarms are configured.

- Fault

Error alarms indicate operational errors such as excess motor temperature. Error alarms are configured. These are high-priority alarms and must therefore be acknowledged.

- System

System alarms are triggered by the HMI device. They are not configured. System alarms provide information on operator errors or communication faults.

- STEP 7 alarm classes

The alarm classes configured in STEP 7 are also available for the HMI device.

- Custom alarm classes

It is possible to configure additional alarm classes.

Alarm buffer

All incoming, outgoing and acknowledged alarm events are logged to an internal volatile buffer memory. The size of this alarm buffer depends on the type of HMI device.

Alarm protocol

When alarm logging is activated, alarm events are printed out directly on the printer.

You can individually configure each alarm to be printed out.

Alarm log

Alarm events are stored in an alarm log if one is configured. The log file capacity is limited by the storage medium and system limits.

Alarm view

Events stored in the alarm buffer and the alarm log file can be output to the alarm screen in runtime.

The alarm view is used to indicate process alarm events. Whether alarm events need to be acknowledged or not is defined in your configuration data.

Alarm window

A configured alarm window shows all queued alarms or alarms of the relevant alarm class which require acknowledgement. The alarm window opens when a new alarm is received.

You can configure the order in which the alarms are displayed. You can choose to sort alarms in ascending or descending order of their occurrence. The alarm window can also be set to indicate the exact location of the fault, including the date and time of the alarm event.

Alarm indicator

An alarm indicator icon is displayed if at least one error alarm is queued on the HMI device.

The indicator flashes as long as unacknowledged alarms are pending. The displayed number indicates the number of pending alarms.

8.3 Tags

Definition

Tags represent defined memory areas on the HMI device to which values are written to or read from. This action can be initiated on the controller or by the operator at the HMI device.

8.4 Logs

Overview

Alarm events and process values can be saved to log files.

Examples of alarm events are the incoming, acknowledged and outgoing events occurring with an error alarm.

Process value logging is used for the following purposes:

- Early detection of danger / fault states
- Increase of productivity
- Enhancement of product quality
- Optimization of maintenance cycles
- Documentation of processes
- Quality assurance

Memory options

Depending on the configuration, the logs are written to a file or stored in a database configured for this.

- Logging to a CSV file

The project engineer must have specified a folder path for storing the CSV file containing your logged data. This references the storage location.

CSV format table columns are separated by separators; the table rows are terminated by a line break character. This allows you to evaluate or edit your log data using an external text editor or spreadsheet program.

- Logging to a database

By storing your log files in a database, you can utilize the full database functionality for further processing and analysis of the logged data.

Databases tested and released for WinCC flexible:

- MS Data Engine 97 and MS Data Engine 2000
- MS Access 97 and MS Access 2000
- MS SQL Server 7.0 and MS SQL Server 2000

Logging methods used in WinCC flexible Runtime:

- Circular log
- Segmented circular log
- Log with level-dependent system alarm
- Log file with data volume-based system alarm

Alarm logs

Project alarms indicate fault states and operating states of a process. They are generally triggered by the controller. Alarms can be output to the HMI device in the form of images. WinCC flexible allows you to log alarms and document operational and error states within a plant.

The following data are logged to the file:

- Date and time of alarm
- Alarm number
- Alarm tags (up to 8)
- Alarm status
- Alarm text (optional)
- Fault location (optional)

All alarms are assigned to a specific alarm class. All alarm classes can be logged.

Alarms can be logged either automatically or by operator intervention.

The contents of log files can be output to the HMI device if a corresponding alarm view has been configured.

Data logs

In Runtime, the process values are logged, processed and, depending on the project, written either to files or to the log database.

Data logging is controlled by means of cyclic operations and events. Logging cycles are used to ensure continuous acquisition and storage of the data. In addition, data logging can also be triggered by events, e.g. when a value changes.

8.5 Reports

Overview

Logs are used to document process data and completed production cycles. The log content and layout are specified in the project, as is the event which triggers the printout of the report.

For example, a log can be configured for output at the end of a shift in order to record downtimes. A log can also be configured to document product testing or quality inspections (ISO 9000).

Edition

Reports are printed in Runtime either automatically, e.g. by means of a scheduler, or manually, e.g. by means of a softkey.

Printing reports

Reports are output to the printer in graphic mode. The use of a serial printer is not recommended because of the accumulated data volume.

For proper output, the printer must support the paper format and page layout of the report.

Note

The value of a tag in the report is read and output at the moment of printing. A substantial time may elapse between printing out the first and the last page of a report with numerous pages. This may lead to the same tag on the last page being output with a different value from that on the first page.

8.6 System functions and scripts

Application

System functions and scripts are used in Runtime for the following purposes:

- To control the process
- To utilize the properties of the HMI device
- To make system settings on the HMI device online

In WinCC flexible, each system function and each script is linked to an object, such as a button, field or screen, and an event. An event immediately triggers the system function.

System functions

System functions are predefined functions that are used to implement many tasks in Runtime. For example:

- Calculations, e.g. increase of a tag value by a specific or variable amount
- Logging function, such as starting a process value log
- Settings, such as changing the PLC or setting a bit in the PLC
- Alarms, for instance after logon of a different user

Scripts

Scripts may also be included in the project for specific applications which may require additional functions. For the creation of scripts, WinCC flexible provides an interface to Microsoft Visual Basic Script (VBScript). This allows you to integrate additional functions such as:

- Conversion of values, e.g. between different physical units (temperatures)
- Automation of production sequences

A script can control a production sequence by transferring production data to a PLC. The status can be checked based on the returned values, and appropriate measures can thus be initiated.

Events

The object and the selected function determine what events can be defined as triggers for executing a system function.

For example, the events "Change value", "BelowLowerLimit" and "AboveUpperLimit" belong to the "Tag" object. The "Loaded" and "Cleared" events belong to the "Screen" object.

8.7 Safety

Overview

Operation in Runtime is protected by the use of user groups, passwords and logoff times. After starting Runtime, type in the user name and password in the login dialog.

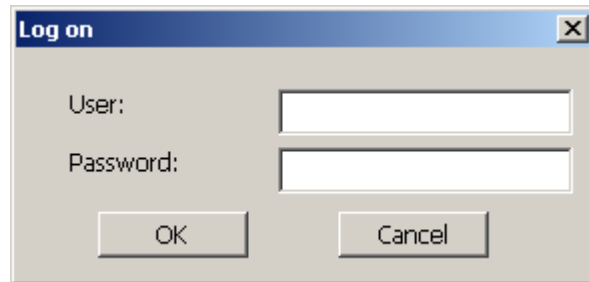

User groups

The security concept of WinCC flexible is organized in several layers. It is based on authorizations, user groups and users.

- User groups are created for specific projects by the project engineer. The "Administrators" group is included in all projects by default. User groups are assigned authorizations. The operation authorizations for individual user groups are specifically defined for all individual objects and functions in the project.
- User accounts are created by the project engineer or by the administrator in Runtime or by a user with the same rights. Users are always assigned to only one group.

After the project has been transferred, the system contains the "Admin" user who belongs to the "Administrators" group (group with maximum rights) and the user accounts created by the project engineer. Any further user accounts are created by the administrator as required.

Users belonging to the group with "Administration" authorization may create further user accounts and assign these to a group.

Passwords

Only registered users may log on to Runtime by entering their user names and passwords. The passwords can be assigned by the project engineer, by the "Admin" user (or by users who have "Administration" authorization), or by the user.

Which functions a user may execute after login depends on which user group he/she is assigned to.

After the initial transfer of the project, only the administrator is authorized to create user accounts and user groups and to change passwords. Any further users assigned to the "Administrator" group by the administrator can also perform these tasks.

The list will be encrypted and saved on the HMI device to protect it from loss due to a power failure.

Note

Depending on the transfer settings, changes to the password list are overwritten when the project is transferred again.

Log-off times

A logoff time is specified in the system for each user. If the time between any two user actions, e.g entering a value or pressing a key, is longer than this logoff time, the user is automatically logged off. The user must then log on again to continue to operate Runtime.

User view

Use the user view to display the users available on the HMI device.

User	Password	Group	Logoff time
Administrator	*****	Administrators	5
Miller	*****	Programmer	5
Smith	*****	Operators	5

Export and import

A user view contains all users, passwords, group assignments and logoff times set up on the HMI device. With an appropriate configuration, you can export this data and then import it to another device. In this way you can avoid reentering the data on another HMI device.

Notice

The currently valid passwords are overwritten during an import. The imported passwords are valid immediately.

8.8 Other operating functions

Print functions

Print functions available in online mode: :

- Hardcopy
You can print the contents of the currently displayed screen using the "PrintScreen" system function in your configuration.
- Alarm protocol
All alarm events (incoming, outgoing, acknowledgment) are also output to a printer.
- Printing reports

Note

Special, non-European characters

When printing non-West European alarms, some characters are not printed under certain circumstances. The result of printing is dependent on the printer used.

Note

Printing via a network printer

Printing alarms on a network printer is not approved for Windows CE HMI devices. All other functions have no restrictions, even over the network.

LED control

The light-emitting diodes (LED) in the softkeys of your SIMATIC HMI devices can be controlled by the PLC. For example, a lit or flashing LED may prompt the operator to press a specific softkey on the device.

Operate project

9.1 Basic principles of operation

9.1.1 Basics for operation in runtime

Introduction

The process control features are defined by the project configuration and the options available on the HMI device. This chapter contains general information on the settings for the runtime software and the operation of predefined screen objects.

Screen objects provide general system functions. Screen objects can be used and configured in screens in the project.

WinCC flexible Runtime can be operated with the keys, the touchscreen or via keyboard and mouse, depending on the HMI device used.

Multiple key operation

Multiple key operation can trigger unintentional actions.

- When you use a key device, you may not press more than two function keys simultaneously.
- If a touchscreen is used, do not operate more than one touch object at a time.

Language switching

WinCC flexible allows a multilingual project configuration. Up to five of these project languages can be loaded on the HMI device simultaneously.

Runtime allows you to change the languages provided this function is configured. Language-specific objects such as texts or formats are localized. The following objects may contain language-relevant texts:

- Alarms
- Screens
- Text lists
- Help texts
- Recipes
- Date/time
- Static texts

Objects in the template screen

Objects which should be available on each screen are configured in the template by the project engineer, e.g. important process values or date and time.

An operating element in a permanent screen area is available in all screens. In the case of touch panels, a button in a template screen represents a globally effective softkey.

Pictograms

In the case of keyboard devices, icons can be configured along the bottom and side margins of the screen.

Icons highlight the screen-specific functions of the softkeys. Use the associated softkey to trigger the function symbolized by the icon.

9.1.2 Operating the touch panel

9.1.2.1 Operating touch objects

Operation

Touch objects are touch-sensitive operating objects on the HMI device screen, e.g. buttons, I/O fields and alarm windows. The operation of these is basically no different than the operation of conventional keys. You operate these objects by touching them with your finger.



Caution

Always touch only one object on the screen. Do not touch several touch objects simultaneously. You may trigger an unintended action.

Caution

To avoid damaging the plastic surface of the touchscreen, do not use any pointed or sharp objects to operate the screen.

Direct keys

With a PROFIBUS DP coupling, it is also possible to configure buttons for operation as direct keys in order to allow rapid key operation. Rapid key operation is required for jog mode, for example.

PROFIBUS DP direct keys on the HMI device are used to set bits in the I/O area of a SIMATIC S7.

Note

Direct keys can only be triggered by touch and not by a mouse click from a connected external USB mouse.

Note

With touch operation, direct keys are triggered regardless of the configured password protection.

Notice

Direct keys are still active when the HMI device is in the "offline" mode.

Button action feedback

The HMI device outputs an acoustic and optical signal as soon as it detects the operation of a touch object. This feedback is always output, regardless of communication with the PLC. The feedback does not indicate whether the relevant action is actually executed or not.

Acoustic acknowledgement

The HMI device outputs a beep to signal operation of a touch object. You can disable this beep.

Visual feedback

The type of visual feedback depends on the operated touch object:

- Buttons

The HMI device outputs different indicators of the "Touched" and "Not touched" states if the programmer has configured a 3D effect.



Touched Untouched

The programmer defines the layout of a selected field (e.g. line width and color of the focus).

- Hidden buttons

The focus of hidden buttons is not set after marking (focus width value is 0 by default.) In Runtime, the outline of a touched button is indicated as a line when you modify the focus with value in the configuration data. This outline remains visible until the focus is set on another operating object.

- I/O fields

After you touch an I/O field, a screen keyboard appears as a feedback signal.

Operating screen objects with buttons

Screen objects with predefined buttons can also be operated with external buttons. This requires the programmer to have linked the relevant system functions to these buttons.

In WinCC flexible, these system functions are organized in the "Keyboard actions for screen objects" group.

See also

Volume & Sounds (Page 6-17)

9.1.2.2 Input of values

Screen keyboard

The HMI device automatically opens the screen keyboard when you touch an I/O field to enter values. This screen keyboard is also displayed to input of passwords for access to protected functions. The HMI device automatically hides the keyboard when input is complete.

Based on the configuration of the I/O field, the HMI device shows a screen keyboard only for the input of numeric or alphanumeric values.

To enable the screen keyboard:

- In Runtime, select an I/O field.
- Depending on the configuration, you can activate or deactivate the automatic display of the screen keyboard as required. This feature is useful when an external keyboard is connected to the HMI device and the screen keyboard is not required.

The screen keyboard can be permanently displayed. Use the operating element provided by the project engineer. The screen keyboard is now visible until closed by the operator, and can also be used for input in other applications.

9.1.2.3 Input of numeric values

Entering numeric values for the MP 270B 6" Touch or TP 270 6"

Numeric screen keyboard

The HMI device automatically opens the numeric screen keyboard for the input of numeric values when you touch an I/O field on the screen. The HMI device automatically hides the keyboard when input is complete.

The <Help> button is only active if an operator note is configured for the I/O field.

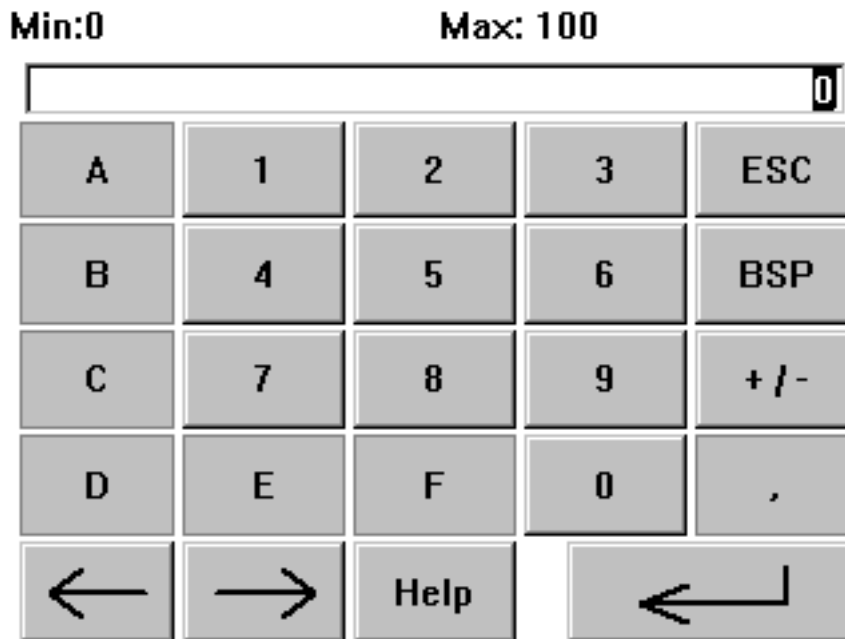

Figure 9-1 Example of numeric input on the screen keyboard

Note

The <BSP> key corresponds to the <Backspace> key and deletes the character to the left of the current cursor position.

Procedure

Numeric and hexadecimal values are entered, character by character, using the screen keyboard buttons. Confirm the value entered by pressing <Enter> or cancel it with <ESC>. Both functions will close the screen keyboard.

Note

The numeric input fields may be assigned limits. In this case, the system accepts only the values which lie within the configured range. The system rejects any values which are outside these limits and restores the original value. In this case, the HMI device outputs a system alarm.

If configured, the lower and upper limit values are displayed when the screen keyboard is opened.

Note

When the screen keyboard is open, PLC job 51, "Select Screen" has no function.

Entering numeric values for the MP 270B 10" Touch or TP 270 10"

Numeric screen keyboard

The HMI device automatically opens the numeric screen keyboard for the input of numeric values when you touch an I/O field on the screen. The HMI device automatically hides the keyboard when input is complete.

The <Help> button is only active if an operator note is configured for the I/O field.



Figure 9-2 Screen keyboard for numeric input

Procedure

Enter the characters of numeric values using the screen keyboard buttons. Confirm the input value with <Enter> or cancel it with <Esc>. Both functions will close the screen keyboard.

Note

The numeric input fields may be assigned limits. In this case, the system accepts only the values which lie within the configured range. The system rejects any values which are outside these limits and restores the original value. In this case, the HMI device outputs a system alarm.

When you input the first character, a tooltip appears showing the high and low limit values of the input field.

9.1.2.4 Input of alphanumeric values

Entering alphanumeric values for the MP 270B 6" Touch or TP 270 6"

Alphanumeric screen keyboard

The HMI device automatically opens an alphanumeric keyboard for the input of strings and numeric values in hex format when you touch an input object on the screen. The HMI device automatically hides the keyboard when input is complete.

The <Help> is only active if an operator note is programmed for the input object.

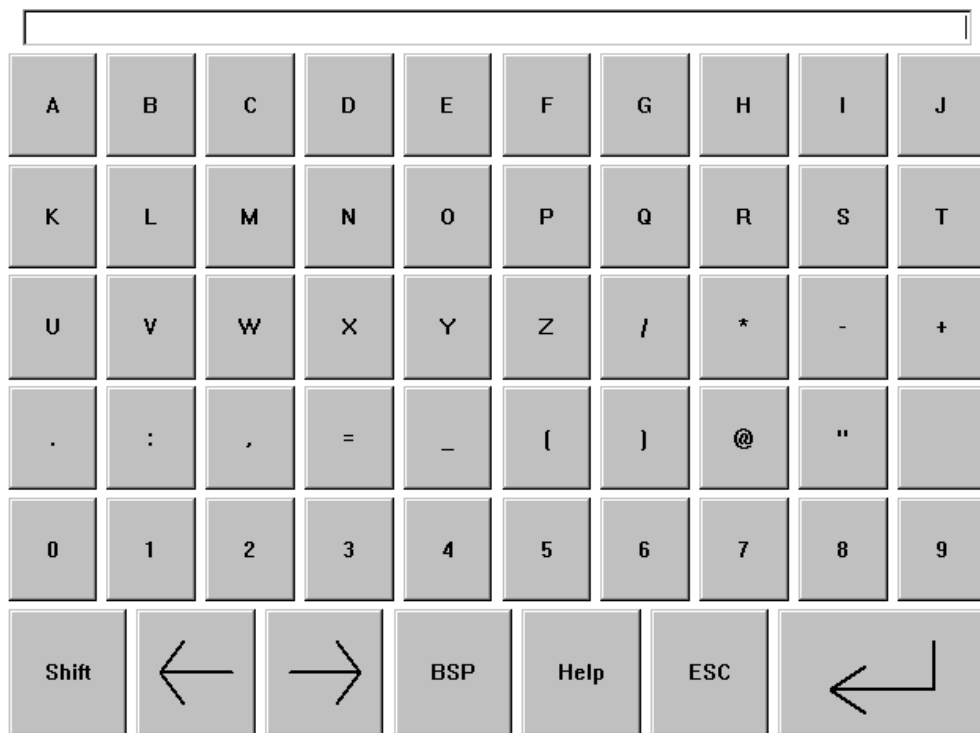

Figure 9-3 Screen keyboard for alphanumeric input

Note

The <BSP> key corresponds to the <Backspace> key and deletes the character to the left of the current cursor position.

Keyboard layers

The alphanumeric keyboard is organized in several layers:

- Standard layer (refer to figure)
- <Shift> layer

Procedure

Use the screen keyboard buttons to input the characters of alphanumeric values. Confirm the value entered by pressing <Enter> or cancel it with <ESC>. Both functions will close the screen keyboard.

Note

When the screen keyboard is open, PLC job 51, "Select Screen" has no function.

Entering alphanumeric values for the MP 270B 10" Touch or TP 270 10"

Alphanumeric screen keyboard

The HMI device automatically opens an alphanumeric keyboard for the input of strings and numeric values in hex format when you touch an input object on the screen. The HMI device automatically hides the keyboard when input is complete.

The <Help> is only active if an operator note is programmed for the input object.



Figure 9-4 Screen keyboard for alphanumeric input

Keyboard layers

The alphanumeric keyboard is organized in several layers:

- Standard layer (see the figure)
- <Shift> layer
- <Alt Gr> layer
- <Shift+Alt Gr> layer

The <Alt Gr> and <Shift+Alt Gr> layers are used for the input of special characters.

Procedure

Use the screen keyboard buttons to input the characters of alphanumeric values. Confirm the input value with <Enter> or cancel it with <Esc>. Both functions will close the screen keyboard.

9.1.2.5 Calling the operator note

Purpose

The operator notes provide the programmer with additional information and operating instruction relating to alarms, screen and operable screen objects. A operator note may contain information about the permissible range of values for an I/O field or information on the causes of alarm events and their elimination.

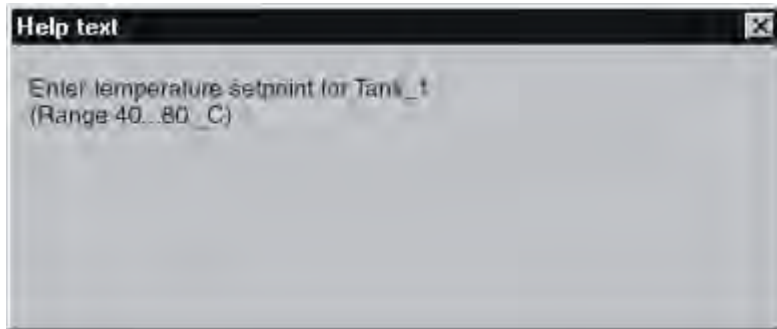
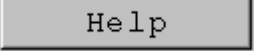

Figure 9-5 Operator note for an I/O field (Example)

Help on alarms

Actuate the  button on the alarm screen or in the alarm view

Help on input objects

Touch the <Help> button on the screen keyboard. This button is only available if you configured an operator note.

Help on the current screen

If the "ShowOperatorNotes" function is assigned to a button, for example, in the configuration, press that button to display the operator notes regarding the current screen.

Help on the focused screen object

Use the <Alt+H> key combination on the screen keyboard or on the connected USB keyboard to display the operator notes configured for the focused screen object.

Note

To view a new operator note, you first need to close the window showing the current operator note.









9.1.3 Operating a keyboard device











9.1.3.1 Functions of the system keys

Overview of system key functions

Note

The availability of system keys is determined by the HMI device used.













Key	Function	Purpose
	Shift (digits/letters)	<p>Toggles the assignment from numbers to letters.</p> <ul style="list-style-type: none"> No LED is lit: The number assignment is enabled. One actuation of the button toggles to letter assignment. One LED is lit: The left or right letter assignment is enabled. <p>Each time the key is pressed, the system toggles between the right letter assignment and number assignment.</p>
	Deleting characters	<ul style="list-style-type: none"> Deletes the character at the current cursor position.
	Cancel	<ul style="list-style-type: none"> Deletes the input characters of a value and restores the original value. Closes the active window.
	Acknowledge	<p>Acknowledges the currently displayed error alarm or all alarms of an acknowledgement group (group acknowledgement.)</p> <p>The LED is lit as long as unacknowledged error alarms are queued.</p>
	Display operator notes	<p>Opens the configured operator note for the selected object (e.g. a alarm, I/O field.) The LED signals an that an operator note exists for the selected object.</p>
	Enter	<ul style="list-style-type: none"> Applies and closes the input Opens a drop-down list for symbolic I/O fields Triggers buttons
	Tab	<p>Selects the next available screen object in the configured tab sequence.</p>
	Deleting characters	<p>Deletes the character to the left of the current cursor position.</p>











Key	Function	Purpose
   	Moving the cursor	<ul style="list-style-type: none"> Selects the next operable screen object on the right or left, above or below the current screen object. Navigates in the screen object.
	Scrolling back	Scrolls one page down.
	Scrolling up	Scrolls one page up.
	Shift (upper/lower case)	Use in key combinations, for example, for switching to uppercase letters.
	Shift (special character)	Use in key combinations for the input of special characters. Some of the keys contain a blue special character on their bottom left corners, e.g. the "%" character. In order to input these characters, press the relevant key in combination with the special character key shown on the left.
	General control functions	Used in key combinations, for example, for navigating through trend views.
	General control functions	Used in key combinations, for example, for the "Status force" screen object.

9.1.3.2 Functions of the key combinations









General operation

Navigation



Shortcut keys	Function
 + 	Selects the previously available screen object in the configured tab sequence.
 +   +   +   + 	Positions the cursor within a screen object, for example, in an I/O field.
 + 	Jumps to the start of the selection list.

Shortcut keys	Function
 + 	Jumps to the end of a selection list.
 +  + 	Selects a group of entries between the current position and the top of the list.
 +  + 	Selects a group of entries between the current position and the end of the list.
 + 	Opens a selection list.









Monitor screen settings

Shortcut keys	Function
 + 	Increases the brightness of the monitor screen.
 + 	Reduces the brightness of the monitor screen.
 + 	Increases the screen contrast (OP 270 only).
 + 	Reduces the screen contrast (OP 270 only).

In the startup phase

Shortcut keys	Function
 + 	Toggles the HMI device to "transfer" mode.
	You can always exit transfer mode provided the unit is currently not transferring any data.

Further functions (e.g. in the Explorer)



Shortcut keys	Function
 + 	Accepts the selected entry without closing the list.
 + 	<ul style="list-style-type: none"> • Toggles the active window. • Toggles between the base area and the window.
 + 	Selects all (left letter assignment is active.)
 + 	Shows the properties of a selected element.

Navigating in the operating system

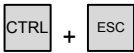
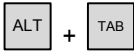



General

Shortcut keys	Function
	Opens the Windows CE Start menu.
	Opens the task manager.

Explorer

Shortcut keys	Function
	Changes to the parent level.
	Toggles the display range.
	Activates the menu bar.

Dialogs

Shortcut keys	Function
	Jumps to the next field.
	Jumps to the previous field.
	Opens the next tab if the focus is set on the name of this tab.
	Opens the previous tab if the focus is set on the name of this tab.
	Closes the dialog without saving.

Operating screen objects with softkeys

You may also operate screen objects with buttons, e.g. the alarm view, trend view, recipe view or status force, using softkeys. The programmer must have linked the corresponding system function to the softkey.

In WinCC flexible, these functions are organized in the "Keyboard actions for screen objects" group.

9.1.3.3 Input of values

Selection

When you select an object, the content entire field is highlighted by a color change. After pressing any key (except the cursor key), the functions immediately deletes the field content and displays the new entry.

To move the cursor to any position in the selected box, press the key  plus the relevant cursor key. The selection of the field content is cancelled.

Note

To enter the hexadecimal characters "A" to "F", toggle the input keys using  to activate the letter assignment.

Numeric I/O boxes may be assigned limit values. In this case, the system accepts only the values which lie within the configured range. The system rejects any values which are outside these limits and restores the original value. In this case, the HMI device outputs a system alarm.

9.1.3.4 Calling the operator note

Purpose

The operator notes provide the programmer with additional information and operating instruction relating to alarms, screen and operable screen objects. An operator note may contain information about the permissible range of values for an I/O field (refer to figure below) or, in the case of an alarm, information on the causes of an alarm event and its elimination.

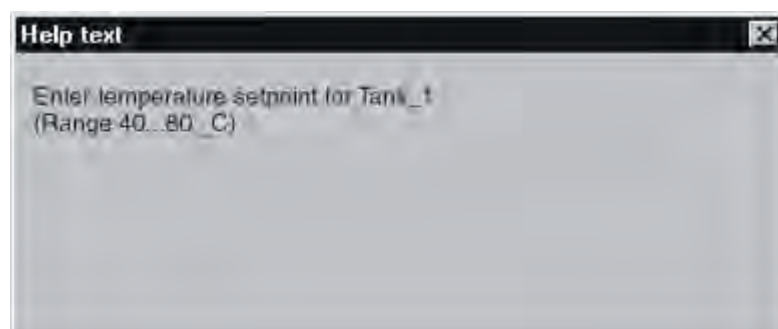



Figure 9-6 Operator note for an I/O field (Example)

Procedure

To display the operator note configured for an I/O field:

1. Select the I/O field, e.g. .

The I/O field is selected. The LED signal of the  key indicates that an operator note is available.

2. Press  to display the operator note.

The operator note is shown in the language currently set on the HMI device. Any operator note configured for the current screen is shown when you press the key again.

3. Close the Help window with the  key or by pressing the  key again.

Note

To view a new operator note, you first need to close the window showing the current operator note.

See also

Set language (Page 7-12)

9.2 Controlling graphic objects

9.2.1 Button

9.2.1.1 Description

Purpose

A button is a virtual key on the HMI device screen that can have one or more functions.



The functions are executed by one of the following events:

- Click
- Press
- Release
- Enable
- Disabling
- Change

Layout

A button can be labeled, use a graphic symbol or be hidden.

The operation may be followed with a visual feedback. Note that the visual feedback only indicates a completed operation and not whether the configured functions were actually executed.

9.2.1.2 Touch control



Procedure

Touch the button on the touch screen of the HMI device.

9.2.1.3 Keyboard control

Procedure

To operate a button with a keyboard:

- Use the cursor to select the button, e.g. 
- Then press  or .

9.2.1.4 Mouse and keyboard control

Procedure

Mouse

Click on the button with the mouse pointer.

Keyboard

Select the button with <Tab> according to the configured tab sequence, then press <Return> or <Space>.

9.2.2 Switch

9.2.2.1 Description

Purpose

The switch is an operating element and display object with two states: "pressed" and "released." Switches can signal the status of a system component that cannot be seen from the HMI device, e.g. a motor. You can also change the status of this system component at the HMI device.

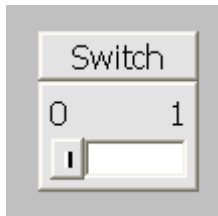

A switch has two stable states. When you actuate the switch, it changes to the other state. The switch retains this status until the next operation.

Layout

A switch can be labeled with a descriptive name, e.g. "Motor 2", and/or the names of its two states, e.g. "ON" and "OFF". The switch can be positioned vertically or horizontally.

9.2.2.2 Touch control



Procedure

Touch the switch on the touch screen of the HMI device.

9.2.2.3 Keyboard control

Procedure

To operate a switch with a keyboard:

- Select the switch with a cursor key, e.g. 
- Then press  or .

9.2.2.4 Mouse and keyboard control

Procedure

Mouse

The operation depends on the type of switch:

- "Switch with text", "Switch with graphic": Click the switch
- "Switch with slider": Click on the slider and move the slider to the other position.

Keyboard

Select the switch with <Tab> according to the configured tab sequence, then press <Return> or <Space>.

9.2.3 I/O field

9.2.3.1 Description

Purpose

You enter numeric or alphanumeric values in an I/O field. An example of a numerical value is the number 80 as setpoint for a temperature. An alphanumeric value is the text "Service" as user name.



Layout

The layout of an I/O field depends on its configuration in WinCC flexible, e.g.:

- Numeric I/O field
For input of numbers in decimal, hexadecimal or binary format.
- Alphanumeric I/O field
For input of character chains
- I/O field for date and time
For input of calendar dates or time information. The format depends on the language set on the HMI device.
- I/O field for password input
For concealed input of a password. The input character string is displayed with placeholders (*).

Behavior

If limit values are configured for the tag that is linked to the I/O field, the input value is only applied if the value is within the configured limits.

Any input values which are outside the range are rejected. The original value is displayed on the I/O field instead, and a system alarm is output on the HMI device.

9.2.3.2 Touch control

Procedure





Press the I/O field on the touch screen of the HMI device. The screen keyboard automatically appears. Enter the desired value using the screen keyboard. Confirm your input with <Enter> or cancel it with <Esc>. After the input has been confirmed or canceled, the screen keyboard is automatically closed.

9.2.3.3 Keyboard control

Procedure

Enable the I/O field with one or several  according to the configured tab sequence. The selection is signaled by the colored field content.

You now have two options:

- Use the cursor keys to position the cursor and then enter your value.
- Press . The object changes to the specific editing mode. Now, only one character will be marked in the field.
 - You can use the  /  cursor keys to scroll the character table.
 - The  /  cursor keys can be used to move to the next or previous input position.

Confirm your entry with  or cancel it with .

9.2.3.4 Mouse and keyboard control

Procedure

Mouse

Click in the I/O field with the mouse pointer. Type in the relevant value. Confirm your input on the HMI device with <Return> or cancel it with <Esc>.

Keyboard

Select the I/O field with <Tab> according to the configured tab sequence. The contents of the I/O field change color to show that it is now activated. You now have two options:

- Type in the relevant value.
- Press <Return>. The object changes to the specific editing mode. Now, only one character will be marked in the field.
 - Use the <Up>/<Down> cursor keys to scroll through a character table.
 - Use the <Right>/<Left> cursor keys to move the cursor to the next or previous input position.

Confirm your input on the HMI device with <Return> or cancel it with <Esc>.

9.2.4 Graphic I/O field

9.2.4.1 Description

Purpose

In a graphic I/O field, select a predefined image from a selection list. The graphic represents the value of a tag. This can be an internal tag or a tag with a connection to a PLC.

The graphic I/O field can be used for pure graphic output dependent on the tag value. In this case, the graphic I/O field can no longer be operated.

Layout

If the graphic I/O field shows a cactus icon, you have not defined the graphic output of a specific value in your project.



9.2.4.2 Touch control

Procedure

Touch the graphic I/O field on the touch screen of the HMI device. The predefined images are displayed in the selection list.









If the selection list has a scroll bar, Touch the scroll bar on the touch screen of the HMI device. touch the touch screen continuously to move the scroll bar in the desired direction.

Select the desired graphic and apply the associated tag value by touching the entry on the touch screen. The selection list is closed and the image is displayed. The graphic I/O field continues to have the focus.

9.2.4.3 Keyboard control

Procedure

Operating a graphic I/O field on a keyboard device:

Step		Procedure	
1	Select the graphic I/O field	e.g. 	The graphic I/O field is marked.
2	Open the selection list		The drop-down list opens.
3	Select the entry	   	Moves the cursor by lines.
4	Accept the selection or		The selected entry is now valid. The drop-down list is closed.
	Cancel the selection		The function restores the original value.

9.2.4.4 Mouse and keyboard control

Procedure

Mouse

Click on the graphic I/O field with the mouse pointer. The predefined images are displayed in the selection list.

If the selection list has a scroll bar, click on the scroll bar with the mouse pointer. Move the scroll bar in the desired direction while holding down the mouse button.

Select the image and apply the corresponding tag value by clicking the entry. The selection list is closed and the entry is displayed. The graphic I/O field remains active.

Keyboard

Select the graphic I/O field with <Tab> according to the configured tab sequence. The contents of the graphic I/O field change color to show that it is now activated.

You can control the graphic I/O field with the following keys:

Key	Function
<Return>	Open the selection list Confirms input. The selection list is closed. The graphic I/O field continues to have the focus.
<Down> or <Right>	Selects the next entry
<Up> or <Left>	Selects the previous entry
<Esc> or <Tab>	Discards the entry and displays the original value in the form of the corresponding graphic.

9.2.5 Symbolic I/O field

9.2.5.1 Description

Purpose

In a symbolic I/O field, select a predefined entry from a selection list. The entry represents the value of a tag. This can be an internal tag or a tag with a connection to a PLC.



The symbolic I/O field can be used for pure output of an entry dependent on the tag value. In this case, the symbolic I/O field can no longer be operated.

Layout

If the symbolic I/O field contains a blank text line in the drop-down list, you have not defined a relevant entry in the project.

9.2.5.2 Touch control

Procedure

Touch the symbolic I/O field on the touch screen of the HMI device. The predefined entries are displayed in the selection list.









If the selection list has a scroll bar, touch the scroll bar on the touch screen of the HMI device. Touch the touch screen continuously to move the scroll bar in the desired direction.

Select the desired entry and apply the associated tag value by touching the entry on the touch screen. The selection list is closed and the entry is displayed. The symbolic I/O field continues to have the focus.

9.2.5.3 Keyboard control

Procedure

To operate a symbolic I/O field with a keyboard:

Step		Procedure	
1	Select the symbolic I/O field	e.g. 	The symbolic I/O field is marked.
2	Open the selection list		The drop-down list opens.
3	Select the entry	   	Moves the cursor by lines.
4	Accept the selection		The selected entry is now valid. The drop-down list is closed.
	or Cancel the selection		The function restores the original value. The drop-down list is closed.

9.2.5.4 Mouse and keyboard control

Procedure

Mouse

Click on the symbolic I/O field with the mouse pointer. The predefined entries are displayed in the selection list.

If the selection list has a scroll bar, click on the scroll bar with the mouse pointer. Move the scroll bar in the desired direction while holding down the mouse button.

Select the entry, then apply the corresponding tag value by clicking the entry. The selection list is closed and the entry is displayed. The symbolic I/O field continues to have the focus.

Keyboard

Activate the symbolic I/O field by pressing the <Tab> key one or more times, corresponding to the configured tab order. The contents of the symbolic I/O field change color to show that it is now activated.

You can control the symbolic I/O field with the following keys:

Key	Function
<Enter>	Opens the selection list. Confirms input. The selection list is closed. The symbolic I/O field continues to have the focus.
<Down> or <Right>	Selects the next entry.
<Up> or <Left>	Selects the previous entry.
<Esc> or <Tab>	Discards the entry and displays the original value in the form of the corresponding graphic.

9.2.6 Alarm indicator

9.2.6.1 Description

Purpose

The alarm indicator is a configurable graphic icon that is displayed on the screen as long as at least one alarm belonging to the specified alarm classes is pending on the HMI device.



Behavior

The alarm indicator flashes as long as unacknowledged alarms are pending. The displayed number indicates the number of pending alarms.

Note

The icons from the symbol library can only be operated with a mouse or touch screen.

9.2.6.2 Touch control

Procedure

Touch the alarm indicator. An alarm window opens depending on the configuration.

Use the Close icon to close the alarm window and operate the screens. The alarm window can be reopened by touching the alarm indicator.

9.2.6.3 Mouse control

Procedure

Click on the alarm indicator with the mouse pointer. An alarm window opens depending on the configuration.

Use the Close icon to close the alarm window and operate the screens. The alarm window can be reopened by clicking on the alarm indicator.

9.2.7 Alarm view

9.2.7.1 Description

Purpose

The alarm view shows alarms or alarm events selected by the planner from the alarm buffer or, if supported by the HMI device, from the alarm log.

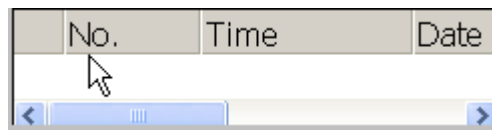

Layout



Alarm classes are identified in the first column of the alarm view to allow for distinguishing between different alarm classes:

Icon	Alarm class
!	Fault
(empty)	Operation
(depending on configuration)	Custom alarm classes
\$	System

In Runtime you can configure the column order and the sorting order of each column.

Operating elements

The buttons have the following functions:

Button	Function
	Use this button to call the configured operator note for the selected alarm.
	This button triggers the function assigned to the "Edit" event for the selected alarm.
	This button is used to acknowledge an unacknowledged alarm.

9.2.7.2 Touch control

Procedure

Touch the desired operating element in the alarm view on the touch screen of the HMI device.

Changing column sequence and sorting sequence

In Runtime you can configure the column order and the sorting order of each column.

- Change column sequence

For example, to reverse the "Time" and "Date" columns, touch the "Date" header on the HMI device touchscreen. Continue to press the touchscreen and drag the column heading to the "Time" heading.

- Change sorting order







To change the chronological order of the alarms, touch the "Time" or "Date" column headings on the HMI device's touchscreen.

9.2.7.3 Keyboard control

Procedure

There is also a tab order in the alarm view for the list showing displayed alarms and all configured buttons.

Proceed as follows to acknowledge an alarm using the keys.

1. Activate the alarm view using , according to the tab order.
2. Select the alarm to be acknowledged. The , ,  and  keys can be used for this.
3. Press and hold the  key until the button to be acknowledged is selected.
4. Press the  key.

9.2.7.4 Mouse and keyboard control

Procedure

Mouse

Click on the desired operating element or list entry.

Changing column sequence and sorting sequence

In Runtime you can configure the column order and the sorting order of each column.

- Change column sequence

For example, to reverse the "Time" and "Date" columns, drag the "Date" header to the "Time" header with the mouse.

- Change sorting order

To change the chronological sorting order of the alarms, click on the header of one of the two "Time" or "Date" columns.

Keyboard

The alarm view also has a tab sequence for the list which shows displayed and all configured buttons.

Do the following to acknowledge an alarm using the keyboard.

1. Activate the screen display with <Tab> according to the tab sequence.
2. Select the alarm to be acknowledged. You can use the keys <Home>, <End>, <Page Up>, <Page Down>, <Up> and <Down> for this.

3. Hold the <Tab> key pressed until the button to be acknowledged is selected.
4. Press the <Return> button.

9.2.8 Simple alarm view

9.2.8.1 Description

Purpose

On HMI devices which have displays smaller than 6" (e.g. OP 77B), the simple alarm view is used for displaying and editing of alarms.

Both alarm views can be used on all other HMI devices.



Layout

The display of the simple alarm view depends on the configuration.

- The display shows all current, departed or acknowledged alarms of the selected alarm classes.
- The number of lines per alarm and the visible lines.

Operating elements

The buttons have the following functions:

Button	Function
	This button is used to acknowledge an unacknowledged alarm.
	This button triggers the function assigned to the "Edit" event for the selected alarm.
	Use this button to call the configured operator note for the selected alarm.

9.2.8.2 Touch control

Procedure







Touch the desired operating element in the alarm view on the touchscreen of the HMI device.

9.2.8.3 Keyboard control

Procedure

The simple alarm view also has a tab order for the list showing displayed alarms and all configured buttons.

Proceed as follows to acknowledge an alarm using the keys.

1. Activate the simple alarm view using , according to the tab order.
2. Select the alarm to be acknowledged. The , ,  and  keys can be used for this.
3. Press and hold the  key until the button to be acknowledged is selected.
4. Press the  key.

9.2.8.4 Mouse and keyboard control

Procedure

Mouse

Click the relevant button.

Keyboard

The alarm view also has a tab sequence for the list which shows displayed and all configured buttons.

Do the following to acknowledge an alarm using the keyboard.

1. Activate the screen display with <Tab> according to the tab sequence.
2. Select the alarm to be acknowledged. You can use the keys <Home>, <End>, <Page Up>, <Page Down>, <Up> and <Down> for this.
3. Hold the <Tab> key pressed until the button to be acknowledged is selected.
4. Press the <Return> button.

9.2.9 Recipe view

9.2.9.1 Description

Purpose

The recipe view is a screen object that is used in runtime to display and edit recipe records.

Layout

The functions of the recipe view can be configured. To use the recipe view on small panels, a simple view is also available.

Different settings are also available to select if a recipe can only be selected or can also be changed.





Behavior



If you change to another screen and have not yet saved changes to the recipe data in the recipe view, you will be prompted to save the recipe data. The recipe name and the name of the recipe record are displayed to show the unsaved recipe data.

When you change to a screen that contains a recipe view loaded with recipe data, the recipe data is automatically updated.

Operating elements

The following operator controls can be configured in the recipe view:

Operator control element	Function
	Displays the configured operator notes of the given recipe view.
	Creates a new recipe record in the recipe displayed in the specified recipe view. The recipe record values are preset with the values that were specified as "Default value" when the recipe was configured.
	Saves the recipe data record currently displayed in the recipe view. The storage location is determined during configuration in the recipe properties view.
	Saves the recipe record currently displayed in the recipe view under a new name. The storage location is determined during configuration in the recipe properties view.
	Deletes the recipe record displayed in the recipe view from the data medium of the HMI device.

Operator control element	Function
	Synchronizes the values of the recipe record currently displayed in the recipe view with the associated tags. During synchronization, all values of the recipe record are written to the associated tags. Then the values are read from the tags and used to update the values in the recipe view.
	Transfers the recipe record currently displayed in the recipe view, to the connected PLC.
	Transfers the recipe record currently loaded in the PLC, to the HMI device and displays it in the recipe view.

9.2.9.2 Touch control

Procedure

Touch the desired operating element in the recipe view on the touchscreen of the HMI device.

Use the screen keyboard to enter values.



9.2.9.3 Keyboard control

Procedure

Activate the recipe view using , according to the configured Tab order.

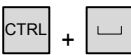
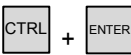
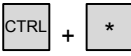
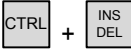
The table below shows the shortcut keys used to control the recipe view.

Shortcut keys	Function
	Creates a new recipe record in the recipe displayed in the specified recipe view. The recipe record values are preset with the values that were specified as "Default value" when the recipe was configured.
	Saves the recipe data record currently displayed in the recipe view. The storage location is determined during configuration in the recipe properties view.
	Saves the recipe record currently displayed in the recipe view under a new name. The storage location is determined during configuration in the recipe properties view.
	Deletes the recipe record displayed in the recipe view from the data medium of the HMI device.

Shortcut keys	Function
	Synchronizes the values of the recipe record currently displayed in the recipe view with the associated tags. During synchronization, all values of the recipe record are written to the associated tags. Then the values are read from the tags and used to update the values in the recipe view.
	Transfers the recipe record currently displayed in the recipe view, to the connected PLC.
	Transfers the recipe record currently loaded in the PLC, to the HMI device and displays it in the recipe view.

9.2.9.4 Mouse and keyboard control

Procedure

Mouse

Click the desired operating element or list entry.

Keyboard

Activate the recipe view with <Tab> according to the tab sequence.

The table below shows the shortcut keys used to control the recipe view.

Shortcut keys	Function
<Ctrl+Space>	Creates a new recipe record in the recipe displayed in the specified recipe view. The recipe record values are preset with the values that were specified as "Basic value" when the recipe was configured.
<Ctrl+Return>	Saves the recipe data record currently displayed in the recipe view. The storage location is determined during configuration in the recipe properties view.
<Ctrl+*>	Saves the recipe record currently displayed in the recipe view under a new name. The storage location is determined during configuration in the recipe properties view.
<Ctrl+Del>	Deletes the recipe record displayed in the recipe view from the data medium of the HMI device.
<Ctrl+=>	Synchronizes the values of the recipe record currently displayed in the recipe view with the associated tags. During synchronization, all values of the recipe record are written to the associated tags. Then the values are read from the tags and used to update the values in the recipe view.

Shortcut keys	Function
<Ctrl+Down>	Transfers the recipe record currently displayed in the recipe view, to the connected PLC.
<Ctrl+Up>	Transfers the recipe record currently loaded in the PLC, to the HMI device and displays it in the recipe view.

9.2.10 Simple recipe view

9.2.10.1 Description

Purpose

On HMI devices which have displays smaller than 6" (e.g. OP 77B), the simple recipe view is used to display and edit recipes.

Both recipe views can be used on all other HMI devices.

Layout

The simple recipe view consists of three areas:

- Recipe selection
- Recipe data record selection
- Recipe entries

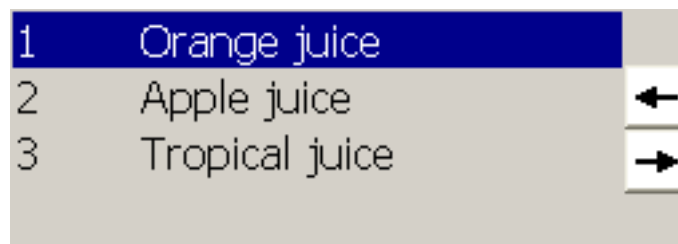



In the simple recipe view, each area is shown separately on the HMI device. The simple recipe view always begins with the recipe selection.

Behavior

A command selection can be opened for each display area by pressing the  button. The command selection lists those commands that are available in the current display area. Each command is assigned a number which you can use to make a selection directly from the list (without using the <Enter> key).

Operating elements

The buttons have the following functions:

Button	Function
	Returns to the previous selection.
	Opens the shortcut menu commands

9.2.10.2 Touch control

Procedure









Touch the desired operating element or list entry in the simple recipe view on the touchscreen of the HMI device.



9.2.10.3 Keyboard control

Procedure

Each command for processing recipes and recipe records is assigned a number that is shown in the command selection. You can select the command directly by pressing the corresponding number key on the HMI device.

The following table lists the key combinations for controlling the simple recipe view:

Shortcut keys	Function
	Calls the shortcut menu commands.
 + 	Selects the previous/next entry.
 	Scrolls one page up or down and selects the corresponding entry.
 +   + 	Selects the first/last entry.

Shortcut keys	Function
	Returns to the previous selection.
	Displays the recipe data records or recipe elements according to the selection.

9.2.10.4 Mouse and keyboard control

Procedure

Mouse

Click the desired operating element or list entry.

Keyboard

Each command for processing recipes and recipe records is assigned a number that is shown in the command selection. You can select the command directly by pressing the corresponding number key on the HMI device.

The following table lists the key combinations for controlling the simple recipe view:

Key	Function
<Right>	Calls the shortcut menu commands.
<Up>/<Down>:	Selects the previous/next entry
<Pg Up>/<Pg Down>	Scrolls one page up or down and selects the corresponding entry
<Home>/<End>	Selects the first/last entry
<Esc>	Returns to the previous selection
<Enter>	Displays the recipe data records or recipe elements according to the selection

9.2.11 Bar

Purpose

The bar is a dynamic display object. The bar displays a value from the PLC as a rectangular area. The operator at the HMI device can thus see immediately how far the current value is from the configured limit value or whether a set point value has been reached. The bar can display values such as fill levels or batch counts.

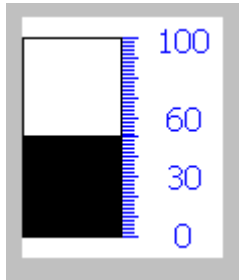

Layout

The layout of the bar is set in the user program. In the bar, for example, lines can identify the configured limit values. Color changes can signal when a limit value has been exceeded or are not met.

Operation

The bar is for display only and cannot be controlled by the operator.

9.2.12 Trend view

9.2.12.1 Description

Purpose

The trend view is a dynamic display object. The trend value can continuously display actual process data and logged process data when it is supported by the HMI device.

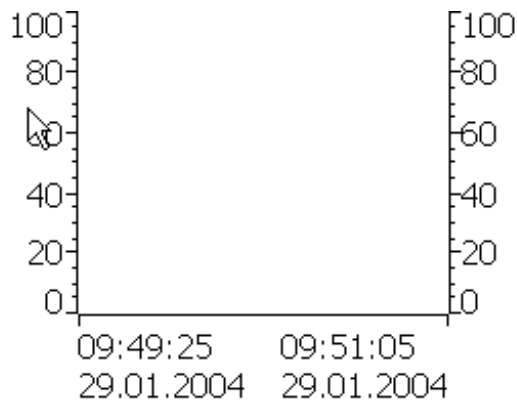









Layout

The layout of the trend view is based on the configuration. A trend view can show multiple curves simultaneously to allow the user to compare different process sequences. If the displayed process value exceeds or falls below the configured limit values, the violation of the limit can be displayed by a change of color in the curve.

A ruler can also simplify the reading of the process values from the trend view. The ruler displays the Y-value that belongs to an X-value.

Operating elements

The trend view is operated by the configured trend display buttons. If no buttons have been configured for the trend view, you can operate it using the keyboard or the function keys of the HMI device. The project engineer must configure and document this type of operation.

Operator control element	Function
	Scrolls back to the beginning of the trend recording. The start values of the trend recording are displayed there.
	Zooms the displayed time section.
	Zooms out of the displayed time section.
	Moves the ruler backward (to the left).
	Moves the ruler forward (to the right).
	Scrolls one display width backward (to the left).
	Scrolls one display width forward (to the right).
	Shows or hides the ruler. The ruler displays the X-value associated with a Y-value.
	Stops or continues trend recording.

9.2.12.2 Touch control



















Procedure

Touch the desired operating element in the trend view on the touch screen of the HMI device.

9.2.12.3 Keyboard control

Procedure

Activate the trend view with  using the tab order configured.
The table below shows the available shortcut keys.

Keys	Function
 + 	Scrolls back to the beginning of the trend recording. The start values of the trend recording are displayed there.
 +  + 	Zooms the displayed time section.
 +  + 	Zooms out of the displayed time section.
 +  + 	Moves the ruler backward (to the left).
 +  + 	Moves the ruler forward (to the right).
 + 	Scrolls one display width backward (to the left).
 + 	Scrolls one display width forward (to the right).

9.2.12.4 Mouse and keyboard control

Procedure

Mouse

Click the desired button.

Keyboard

Activate the trend view with <Tab>, using the tab order configured.
The table below shows the available shortcut keys.

Key	Key (Panel PC)	Function
<Ctrl+Return>	<Ctrl+Return>	Scrolls back to the beginning of the trend recording. The start values of the trend recording are displayed there.
<Ctrl+Plus>	<Ctrl+Plus>	Zooms the displayed time section.
<Ctrl+Minus>	<Ctrl+Minus>	Zooms out of the displayed time section.

Key	Key (Panel PC)	Function
--	<Ctrl+Alt+Left>	Moves the ruler backward (to the left).
--	<Ctrl+Alt+Right>	Moves the ruler forward (to the right).
<Left>	<Shift+Left>	Scrolls one display width backward (to the left).
<Right>	<Shift+Right>	Scrolls one display width forward (to the right).

9.2.13 Slider control

9.2.13.1 Description

Purpose

The slider is used to transfer a numerical value to the PLC by moving the slide to the desired position. Each change in the position of a slider element results in the immediate change of the corresponding value at the associated tag.

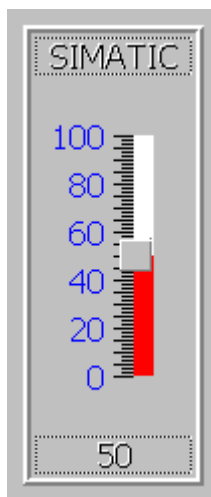

Note

In the following circumstances, the displayed value on the slider control may deviate from the actual value:

- The value range (minimum and maximum value) configured for the slider control does not correspond to the configured limits for the slider control tag.
 - An invalid password has been entered for a password-protected slider control.
-

Layout

If the slider control is used as a display object, the represented value is determined by the position and configuration of the movable slide.

9.2.13.2 Touch control















Procedure

Touch the slider on the touch screen of the HMI device. Move the slider in the desired direction while keeping contact with the screen.

9.2.13.3 Keyboard control

Procedure

One way to operate the slider control with a keyboard is to use the cursor keys
The following table lists the key combinations for controlling the slider control.

Keys	Meaning
 +   + 	Increase value
 +   + 	Reduce value
 HOME  END	Increase value in 5% increments
 +  HOME  +  END	Move to maximum/minimum value

9.2.13.4 Mouse and keyboard control

Procedure

Mouse

Click the slider control. Move the slider control in the desired direction while holding down the mouse button.

Keyboard

Activate the trend view with <Tab>, using the tab order configured.

You can operate the slider with the following keys:

Key	Key (Panel PC)	Function
<Up> or <Right>	<Shift+Up> or <Shift+Right>	Increase value
<Down> or <Left>	<Shift+Down> or <Shift+Left>	Reduce value
<Page up>	--	Increase value in 5% increments
<Page down>	--	Reduce value in 5% increments
<Home>	--	Set maximum value
<End>	--	Set minimum value

9.2.14 Gauge

Purpose

The gauge is a dynamic display object. The gauge displays numeric values in analog form by means of a pointer. For example, the operator at the HMI device can thus see at a glance that the boiler pressure is in the normal range.

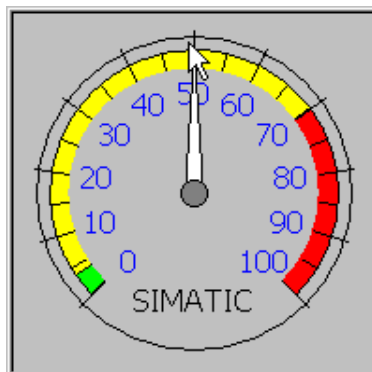

Layout

The layout of the gauge depends on the configuration. Up to three differently colored areas can be set on the scale to visualize different operating states, such as normal operation, warning range and danger range.

A trailing pointer can display the maximum value reached on the scale. The trailing pointer is reset when the screen is reloaded.

The label on the scale can show the measured variable, e.g. boiler pressure, and the physical unit, e.g. bar.

Operation

The gauge is for display only and cannot be controlled by the operator.

9.2.15 Date/time field

9.2.15.1 Description

Purpose

The date/time field indicates the system time and data. In Runtime, you may change the system time and data in accordance with the configuration.

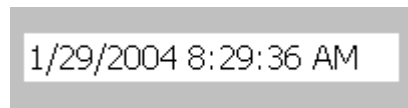

Layout

The layout in the date/time field depends on the language set in the HMI device.

Behavior

Input values other than the date and system time are rejected. Instead, the original values, plus the time that has elapsed in the meantime will appear in the date/time field and a system alarm will be displayed on the HMI device.

9.2.15.2 Touch control

Procedure





Touch the date/time field on the touch screen of the HMI device. The screen keyboard automatically appears. Enter the desired value using the screen keyboard. Confirm your input with <Enter> or cancel it with <Esc>. After the input has been confirmed or canceled, the screen keyboard is automatically closed.

9.2.15.3 Keyboard control

Procedure

Enable the date/time field with one or several , according to the configured tab sequence. The selection is signaled by the colored field content.

You now have two options:

- Use the cursor keys to position the cursor and then enter your value.
- Press . The object changes to the specific editing mode. Now, only one character will be marked in the field.
 - You can use the  /  cursor keys to scroll the character table.
 - The  /  cursor keys can be used to move to the next or previous input position.

Confirm your entry with  or cancel it with .

9.2.15.4 Mouse and keyboard control

Procedure

Mouse

Click in the date/time field. Type in the relevant value. Confirm your input on the HMI device with <Return> or cancel it with <Esc>.

Keyboard

Select the date/time field using the <Tab> key according to the configured tab sequence. The contents of the I/O field will change color to show that it is now activated. You now have two options:

- Type in the relevant value.
- Press <Return>. The object changes to the specific editing mode. Now, only one character will be marked in the field.
 - Use the <Up>/<Down> cursor keys to scroll through a character table.
 - Use the <Right>/<Left> cursor keys to move the cursor to the next or previous input position.

Confirm your input on the HMI device with <Return> or cancel it with <Esc>.

9.2.16 Clock

Purpose

The clock displays the system time of the HMI device.

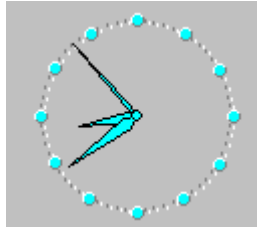

Layout

The time is displayed in analog or digital form, depending on the configuration. The current date is also displayed in the digital display. The display format depends on the language set on the HMI device.

Operation

The clock is for display only and cannot be operated. You can use the date/time field to set the date and time.

9.2.17 User view

9.2.17.1 Description

Purpose

The user view is used by the administrator to manage user accounts, group assignments and user passwords.

Users can change their passwords and logoff times.

User	Password	Group	Logoff time
Administrator	*****	Administrators	5
Miller	*****	Programmer	5
Smith	*****	Operators	5

Layout

The user view contains four columns: user, password, group and logoff time. The passwords are encrypted by means of asterisks.

- The users in the "Administrators" group can view all existing users in the user view, change all entries and create new user accounts.
- Other users only see a single line in the user view showing their own user name.

If the name or password of a logged on user is entered, a system alarm is output.

Export and import

A user view contains all users, passwords, group assignments and logoff times set up on the HMI device. To avoid having to reenter all the data on another HMI device, you can export the user view and import it to another device. However, this is only possible if this function has been configured.

Note

Do not export the password list immediately after changing it. Exit the "User view" object after making changes and wait until the changes have been written to the internal Flash memory before performing the export.

Notice

The currently valid passwords are overwritten during an import. The imported passwords are valid immediately.

9.2.17.2 Touch control

Procedure

To create a new user, touch an empty line. Then use the screen keyboard to type in the user name and confirm your entry with <Enter>. Assign a password and a logoff time in the same way and then select the group.

To change user data, touch the relevant field and make the change.

9.2.17.3 Keyboard control

Procedure

Select the user view with  according to the configured tab sequence.

- To create a new user, select an empty line using the cursor keys and press .

Enter the user name and press . Use  to go to the next field and repeat the procedure.

- To change the user data, select the desired line using the cursor keys and press .

Make the desired changes and complete the action by pressing .

9.2.17.4 Mouse and keyboard control

Procedure

Mouse

To create a new user account, click an empty line. Type in the user name and confirm your entry with <Return>. Assign a password and a logoff time in the same way and then select the group.

To change user data, click the relevant field and make the change.

Keyboard

Select the user view with the <Tab> key according to the configured tab sequence.

To create a new user account, select an empty line using the cursor keys and press <Return>. Type in the user name and confirm your entry with <Return>. Use <Right> to go to the next field and repeat the procedure.

To change the user data, select the desired line using the cursor keys and press <Return>. Then make the relevant changes.

9.2.18 Simple user view

9.2.18.1 Description

Purpose

On HMI devices which have displays smaller than 6" (e.g. OP 77B), the simple user view is used to display users on the HMI device.

Both user views can be used on all other HMI devices.

Layout

Users in the "Administrators" group see all existing users in the user view.

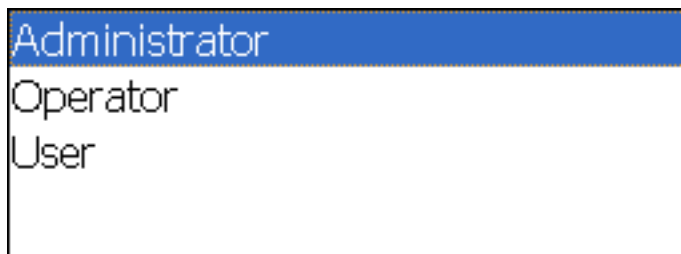

Other users only see a single line in the user view showing their own user name.

9.2.18.2 Touch control

Procedure

Touch the relevant entry in the simple user view on the touch screen of the HMI device.



Use the screen keyboard to input data.

9.2.18.3 Keyboard control





Entering custom user data

Custom user data (name, password, group, logoff time) is entered sequentially in several dialogs.

Procedure

Select the simple user view with , using the tab order configured. Select one of the users displayed using the cursor keys and press .

The following table shows the available key operations for entering custom user data in the dialogs:

Key	Function
 	Selects the previous/next user
	Selects the next element in the dialog
	Opens the next dialog

9.2.18.4 Mouse and keyboard control

Entering custom user data

Custom user data (name, password, group, logoff time) is entered sequentially in several dialogs.

Procedure

Mouse

Start the input mode by clicking on the desired user name.

Keyboard

Start the input mode by activating the simple user view with the <Tab> sequence and then select the user with <Enter>.

The following table shows the available key operations for entering custom user data in the dialogs:

Key	Function
<Up>/<Down>:	Selects the previous/next user
<Tab>	Selects the next element in the dialog
<Enter>	Opens the next dialog

9.2.19 Status/Force

9.2.19.1 Description

Purpose

You read or write access values of the connected PLC directly in the status force view. The status force view allows you to carry out operations such as monitoring or modifying the addresses of the PLC program without the need of an online connection via PC or PU.

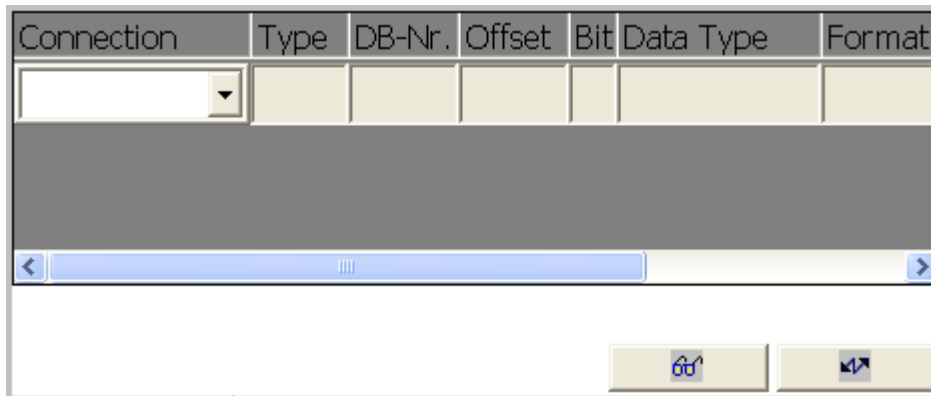

Note

The status force view can only be used in combination with SIMATIC S5 or SIMATIC S7 PLCs.

Layout

The screen shows the general layout of the status force screen object. Every row represents an address.



If your HMI device has a mouse or a touch screen, you can change the column sequence on the HMI device. For example, to interchange the format and control value columns, drag the control value header to the format header.

The table shows the meaning of the individual columns.

Column	Function
Connection	The PLC with the displayed address ranges
Type, DB number, offset, bit	The address range of the operand
Data type, format	The data type of the operand
Status value	The value that was read from the given address of the operand
Control value	The value to be written to the given address of the operand

Operating elements

The buttons have the following functions:

Button	Function
	This button refreshes the display in the status value column. The button engages when it is pressed. You cannot operate any input fields until the button is actuated again and the refresh is stopped.
	Use this button to accept the new value in the control value column. The control value is then written to the PLC.

9.2.19.2 Touch control

Procedure







To enter or edit values, touch the respective field. A screen keyboard or a selection list appears.



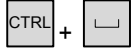

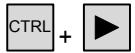
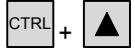
Touch the relevant buttons to write or read the values.

9.2.19.3 Keyboard control

Procedure

The following table lists the key combinations for controlling the status force:

Keys	Meaning
	Operates the "Write" button.
	Operates the "Read" button.
 	Selects the first/last field in the current row.
 	Selects the first/last field in the current column.
	Increases the width of the current column.
	Decreases the width of the current column.

Keys	Meaning
 + 	Deletes the current row. Otherwise: Select no PLC from the "Connection" column.
 + 	Optimize column width.
	Opens selection field.

9.2.19.4 Mouse and keyboard control

Procedure

Mouse

To enter or edit values, click the relevant field. Enter the value using the keyboard, or select a value from the selection list.

Click the desired buttons to write or read the values.

Keyboard

The following keys can be used on the keyboard to operate Status Force.

Key	Key (Panel PC)	Function
<Ctrl+Return>	<Ctrl+Enter>	Operates the "Write" button.
<Ctrl+Space>	<Ctrl+Space>	Operates the "Read" button.
<Ctrl+Left>	<Ctrl+Shift+Left>	Selects first field in current row.
<Ctrl+Right>	<Ctrl+Shift+Right>	Selects last field in current row.
<Ctrl+Up>	<Ctrl+Shift+Up>	Selects first field in current column.
<Ctrl+Down>	<Ctrl+Shift+Down>	Selects last field in current column.
<Ctrl+Del>	<Ctrl+INS/DEL>	Deletes current row.
<Return>	<Enter>	Opens selection list.

9.2.20 Sm@rtClient view

9.2.20.1 Description

Purpose

The Sm@rtClient view may be used to start remote monitoring and control of another HMI device.



With an appropriate configuration, the Sm@rtClient view can be used to monitor and control a system process from multiple HMI devices with the same authorizations.

Layout

The Sm@rtClient view displays the current Runtime screen of the remote device on your HMI device. You can now monitor and control this screen according to your configuration. Scroll bars are displayed if the screen of the remote HMI device is larger than that of your HMI device.

Behavior

Start

The initiation of remote monitoring or control can be configured in different ways. Depending on the project, you can view the Runtime of the remote HMI device in the following ways:

- Automatically when the device is started (and selection of the screen with the Sm@rtClient view if this is not the start screen)
- By activating the Sm@rtClient view with the <Tab> key or by touch on a touch screen device
- By entering the IP address of the remote HMI device and, if required, entering a password in the appropriate field in the Sm@rtClient view

Note

If you enter an incorrect password five times in succession, all attempts to establish a connection are rejected for the next ten seconds.

Stop

The screen showing the display of the remote HMI device can be configured to be closed in different ways. Depending on the configuration, you can terminate the remote monitoring or remote operation and open your project's next object by taking one of the following steps:

- Press the appropriate key.
- Click "Exit".
- Exit the screen.
- Press <Shift+Ctrl> or, with touch panels, press a clear spot for an extended period. The menu opens with the corresponding menu command.

Monitoring mode

On a Sm@rtClient view which is configured for monitoring mode, you can only monitor the remote HMI device. You cannot control its operation.

In this case, the keys retain their standard functions. Press <Tab> to open the next object in the current screen of your project according to the configured tab sequence.

Control mode

The Sm@rtClient view can be run in two different control modes:

- If the "shared" check box is not set in the "Display" area of the "General" property view, only one HMI device can use the remote control function at any time. The others can be used to monitor the activities. Depending on the setting, a further HMI device logon will either be rejected or the existing connection will be shut down so that the new HMI device can connect.
- If the "shared" check box is set in the "Display" area in the property view "General", every HMI device on which remote operation is activated can access the remote HMI device and assume control of the process. Only one HMI device can be active at a time in this case. A different HMI device can assume control when there has been no activity on the active HMI device for a specified period of time.

The appearance of the mouse pointer indicates when operator control is possible.

In both operation modes, the operator at the remote device is not permitted to initiate any further actions.

Note

In the event of an emergency, you can override the operation block on the remotely controlled or currently inactive HMI device by clicking on the user interface five times in succession or by pressing the <Shift> key five times in succession. Then you may have to enter a specific (configured) password.

Keys

In operation mode, all keys have the same function as those on the remote HMI device. You can therefore use the <Tab> key to move from one object to another on the remote screen in the order of the tab configuration.

Function keys

When you press a function key that has been configured with a function, this function will be executed in your project.

If you press a function that has *not* been configured with a function in your project, it will actuate the function key on the remote HMI device.

9.2.20.2 Touch control









Procedure

Touch the desired operating element on the touchscreen of the HMI device.

9.2.20.3 Keyboard control

Procedure

How do I operate the Sm@rtClient view with touch?

- Activate the desired operating element with  according to the configured tab sequence on the remote HMI device.
- Move the scroll bars in the desired direction with  +  or  + .
- To exit the Sm@rtClient view, display a menu line with  + . Use  to make a selection and the corresponding shortcut key for the desired menu command.

9.2.20.4 Mouse and keyboard control

Procedure

Mouse

Click on the desired operating element with the mouse pointer.

To operate a scroll bar, click on it with the mouse pointer and move it in the desired direction while holding down the mouse button.

Keyboard

- Activate the desired operating element with <Tab> according to the configured tab sequence on the remote HMI device.
- You can move the scroll bars in the desired direction with <Ctrl+Up/Down>.
- To exit the Sm@rtClient view, display a menu line with <Shift+Ctrl>. Select the desired menu command with <Alt+Shortcut key>.

9.2.21 Symbol library

9.2.21.1 Description

Purpose

The symbol library is a comprehensive library with images from the areas of technology and production.

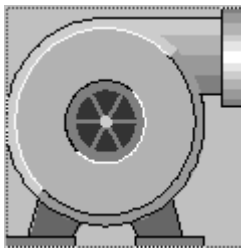

Behavior

The following events can trigger functions when the project engineer has configured them for the symbols:

- Click
- Double-click
- Press
- Release
- Enable
- Disabling

Note

The icons from the symbol library can only be operated with a mouse or touch screen.

9.2.21.2 Touch control

Procedure

Touch the symbol on the touch screen of your HMI device.

There is no operator feedback, for example with color changes.

9.2.21.3 Mouse control

Procedure

Click on the symbol with the mouse pointer. The active mouse function is e-established in Runtime by a changing cursor icon according to your configuration.

There is no operator feedback, for example with color changes.

Operating recipes

10.1 Recipes

Overview

Recipes are a collection of associated data, e.g. machine configuration or production data. You can transfer this data from the HMI device to the controller in a single step in order to change the production variant. If you have programmed directly at the machine you can transfer the data to your HMI device and write it to the recipe.

Operating recipes in Runtime

WinCC flexible offers two options for viewing and editing recipes and their corresponding recipe data records in Runtime on the HMI device:

- Recipe view
- Recipe screen

Recipe view

The recipe view is a screen object that is configured in the "Screens" editor. You can specify what operating function the recipe view will have in Runtime.

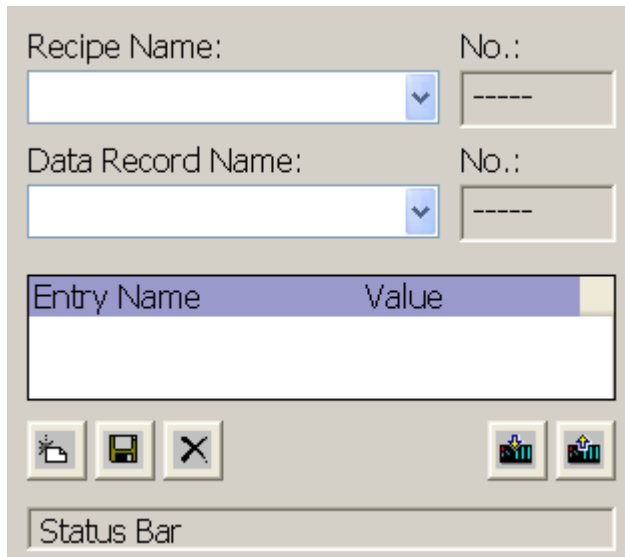

The recipe view shows recipe data records in tabular form. The recipe view is particularly useful if data records are small in size or if only a few values are to be modified.

Recipe screen

A recipe screen is a process screen with a customized input screen form that you create in the "Screens" editor by setting I/O fields and other screen objects. This makes it possible for you to input parameter data in the context of machine visualization. The I/O fields for a recipe can be distributed over multiple recipe screens, with topical organization of recipe elements. The operating functions for the recipe screens must be specifically configured in the process screens.

10.2 Structure of recipes

Introduction

A product often has several variants. Product variants can differ with respect to size or quality. This condition is accurately reflected in a recipe.

Principle

A recipe consists of recipe data records containing values. The structure of a recipe is explained using the example of a filing cabinet.

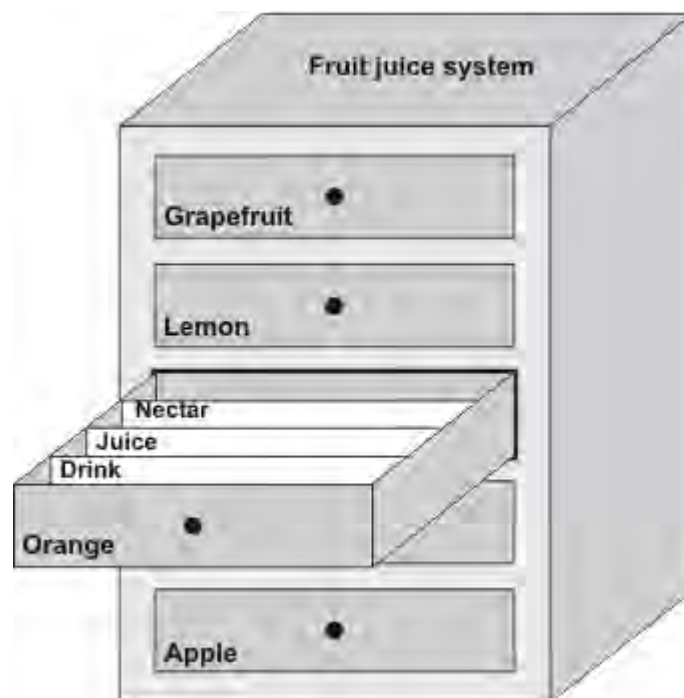

Each recipe represents a drawer of the file cabinet shown and thus precisely one product. If the fruit juice mixing plant is producing orange, apple, and tropical fruit e-esta, you would then configure one recipe for each e-esta.

You define the recipe elements in the recipe. A recipe element consists of the display name and a tag. The display names are indicated in the recipe data records and on the HMI device in the recipe view. In Runtime, the appropriate tag value is read from the controller or transferred to the controller.

10.3 Structure of recipe data records

Introduction

A recipe data record corresponds to a file card in an individual drawer and thus to a single product variant. If the fruit juice mixing plant is producing juice, nectar, and fruit drinks, you would then create a recipe data record in the recipe for each product variant. In this case, the product variants consist of the different mixing ratios for the ingredients.

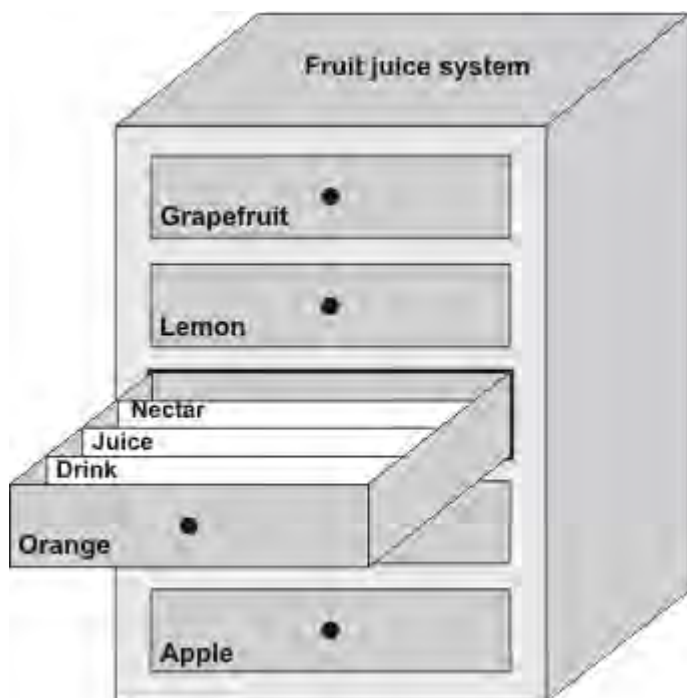

A recipe data record is a set of values for the tags defined in the recipe. You enter the values in the input fields. You can enter the values either during configuration or during runtime on the HMI device or the machine.

Elements		Data records					
	Name	Display name	Numb...	Water	Concentrate	Sugar	Aroma
☰	Beverage	Beverage	1	30	70	45	600
☰	Nektar	Nektar	2	50	50	10	300
☰	Juice	Juice	3	5	95	3	100

To produce a product, you transfer the appropriate recipe data record from the HMI device to the connected controller. The values in the recipe data record cannot be changed on the HMI device unless the configuring engineer has provided for this.

Editing recipe data records

You can edit recipe data records during configuration or in runtime on the HMI device.

- During configuration, you can define recipes in the "Recipes" editor in the "Elements" tab. You can enter values in the recipe data records in the "Data records" tab.
- During runtime, you have the option of entering recipe data record values directly on the HMI device or importing them via a CSV file. You can also export the recipe data records to a CSV file.

10.4 Recipe application

10.4.1 Transfer of recipe data records

Introduction

Recipe data records can be transferred in Runtime between external data storage media, e.g. a flash memory, an HMI device and a controller.

Principle

The figure below shows how recipe data records can be transferred. You configure the appropriate functionality for transferring data records in the recipe view. In a recipe screen, you use the system functions provided for this purpose.

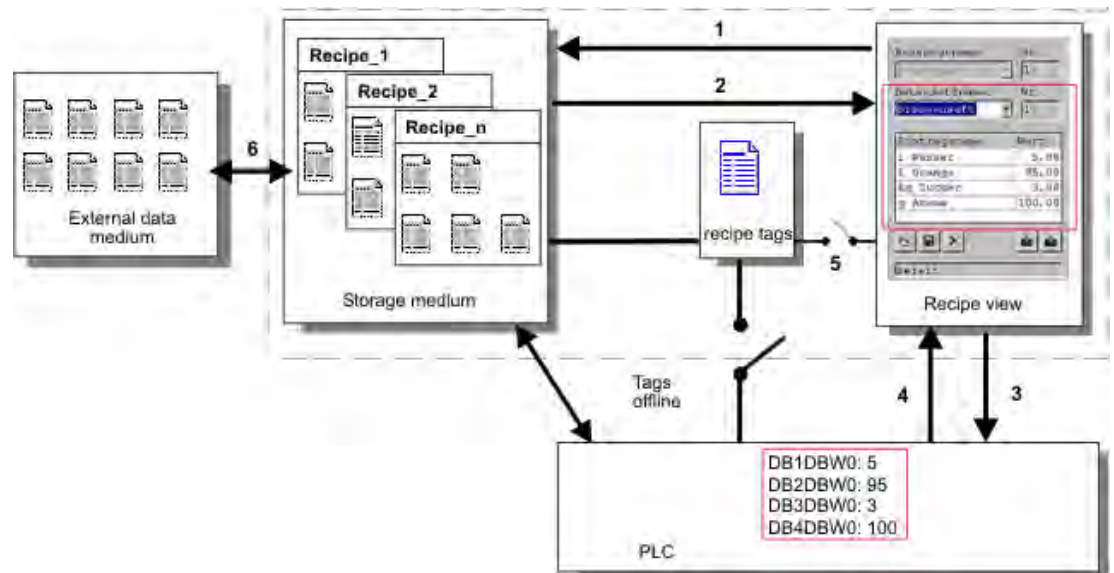

The HMI device stores recipe data records on a storage medium such as a flash memory device or hard disk. You can edit a recipe data record in a recipe view or recipe screen on the HMI device display.

(1) Save: Values you change on the recipe view or recipe screen are written to the recipe data record on the storage medium by executing the "Save" function.

(2) Load: The "Load" function is used to update the values of recipe tags shown on the recipe screen with the values of the recipe data record on the storage medium. The function overwrites any values changed on the recipe screen. The "Load" function is executed for the recipe view when the data record is selected again.

(3) To PLC: if you change values in a recipe view and recipe screen, download the changes to the PLC with the "To PLC" function.

(4) From PLC: Use the "From PLC" function to update the indicated values of the recipe view and recipe screen with the controller values. The function overwrites any data changed on the recipe view or screen.

(5) Synchronization with controller: In your configuration, you can decide to synchronize the values in the recipe view with the values of the recipe tags by setting the "Synchronization with controller" function. After this synchronization, both the recipe tags and the recipe view contain the current updated values. When the "Variables offline" setting is disabled for the recipe, the current values are also applied in the controller.

(6) Import, Export: A data record can be exported to an external storage medium and edited, for example, with MS Excel. The data record is saved in *.csv format.

10.4.2 Configuration of recipes

Introduction

You configure recipes according to your intended application. To write a value to a recipe data record on your HMI device without disturbing the current process, you need configuration settings other than those required for assigning parameters to a machine.

Principle

In the configuration settings of a recipe, you specify the e-establish of the tags you are using in the recipe. The figure below shows the basic differences when working with recipe data records.

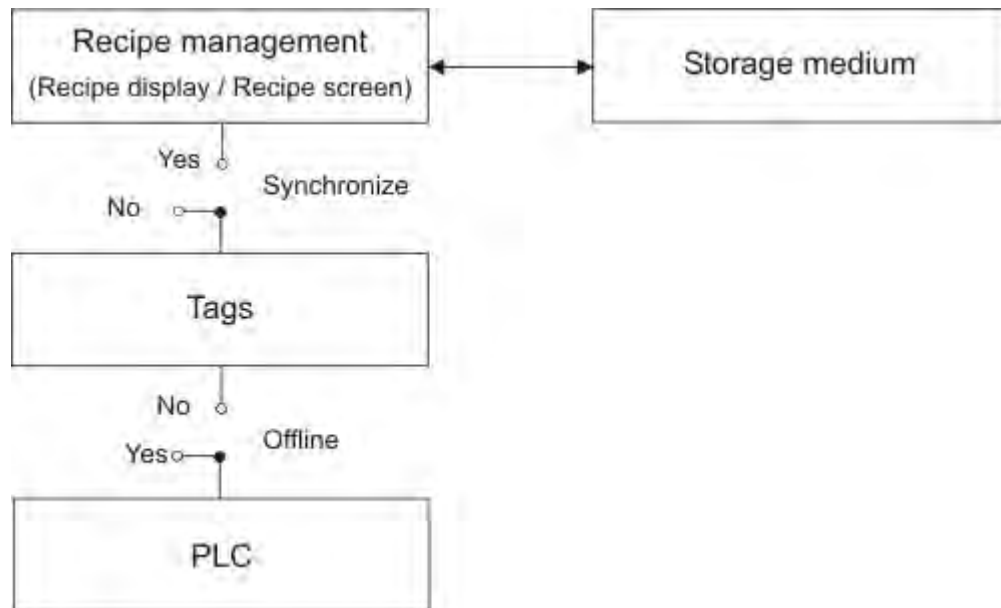

These configuration settings are made under "Settings" in the property view:

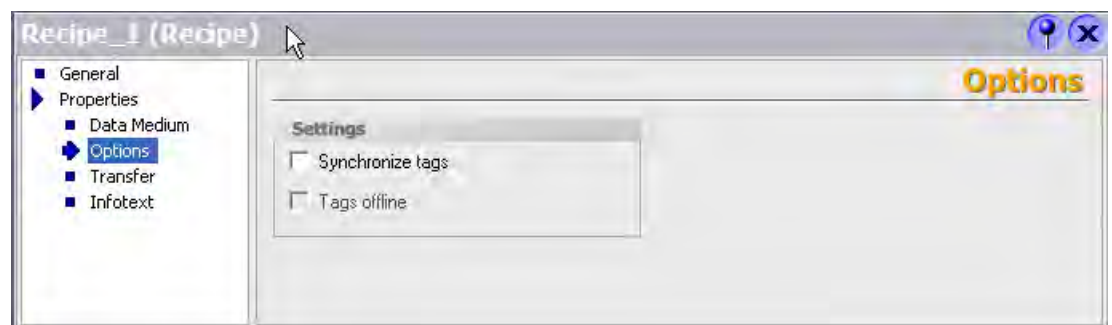

Configuration 1: Recipe without "Synchronize tags"

Data of a data record that has been read are only displayed and can only be edited in the recipe view. Using these same tags outside of the recipe view does not affect their values.

Configuration 2: Recipe with "Synchronize tags" and with "Tags offline"

The "Synchronize tags" option is used to specify that the data of a data record read from the controller or storage medium are to be written to or read from the tags you have configured for the recipe.

The "Offline" option ensures that the input data are written to the tags without being transferred directly to the controller.

Configuration 3: Recipe with "Synchronize tags" and without "Tags offline"

The "Synchronize tags" option is used to specify that the data of a data record read from the controller or storage medium are to be written to or read from the tags you have configured for the recipe.

The input or read data are transferred immediately to the controller:

Synchronization with the controller

In the case of synchronous transfer, both the controller and the HMI device set status bits in the shared data compartment. You can use this mechanism to prevent unintentional overwriting of data in either direction in your control program. You define the address range of the data compartment separately for each controller on the "Range pointer" tab in the "Connections" editor.

Applications for synchronous transfer of recipe data records:

- The controller is the "active partner" for the transfer of recipe data records.
- The controller evaluates the data containing the recipe number and name, as well as the recipe data record number and name.
- Trigger the data record transfer with a system function or PLC job, e.g. with the system functions "SetDataRecordToPLC" and "GetDataRecordFromPLC", or with the PLC jobs "Set_Data_Record_To_PLC" and "Get_Data_Record_From_PLC."

In order to synchronize transfer of data records between the HMI device and the controller, the following requirements must be met during configuration:

- The "Data mailbox" range pointer is located under "Range pointers" in the project view.
- The controller with which the HMI device synchronizes the data record transfer is specified in the recipe properties.

10.4.3 Scenario: Entering recipe data records in Runtime

Objective

You want to enter production data on the HMI device without disturbing the process that is currently underway. Therefore, the production data should not be transferred to the PLC.

Sequence

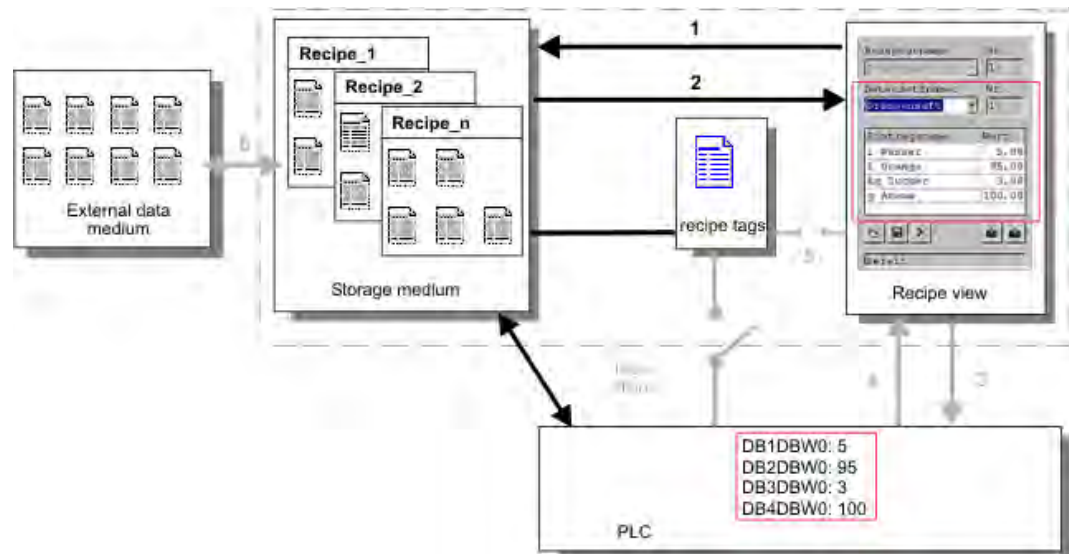

You enter the production data in the recipe view or the recipe screen, assign a recipe data record name, and save the new recipe data record on the storage medium of the HMI device.

Configuration in WinCC flexible

You configure the recipe along with the associated tags.

Synchronization with the recipe tags is not necessary because production data (tags) are not intended to be transferred to the PLC. Make the following settings for the recipe in the property view:

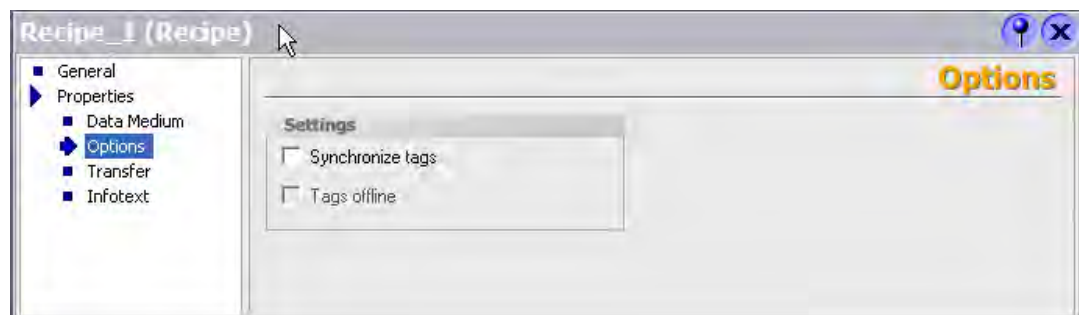

Depending on the extent of the recipe, you either configure a recipe view or create a recipe screen.

10.4.4 Scenario: Manual production sequence

Objective

The production data are to be requested by the PLC according to the work piece to be processed and displayed on the HMI device for inspection. You want to be able to correct the transferred production data online, if necessary.

Sequence

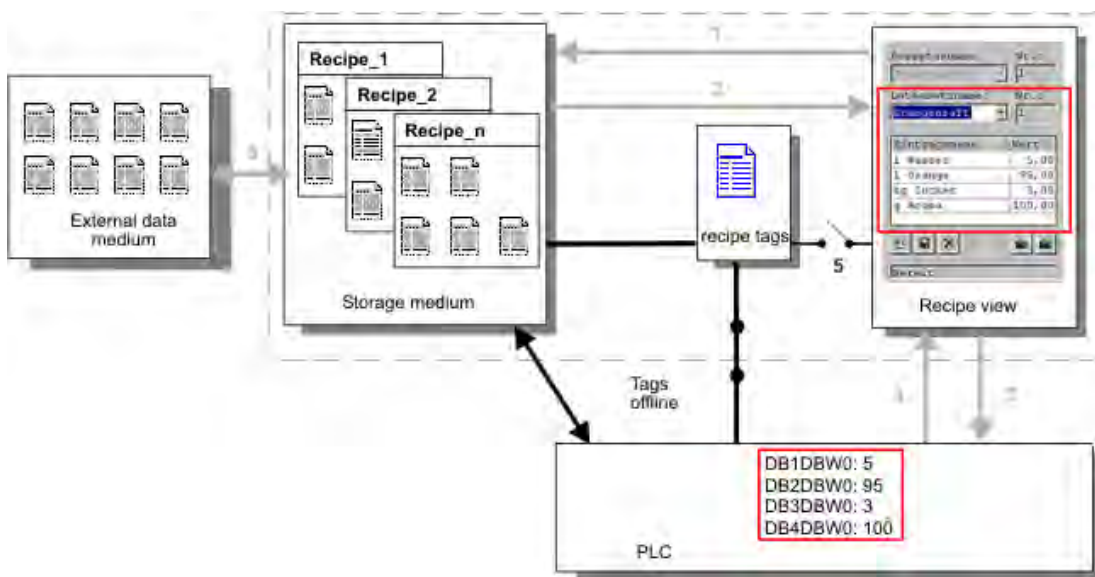

A reading device connected to the PLC reads a bar code on the work piece to be processed. The recipe data record names correspond to the respective bar code names. This will enable the PLC to load the necessary recipe data record from the storage medium of the HMI device. The recipe data record is displayed for inspection. Changes are transferred immediately to the PLC.

Configuration in WinCC flexible

You configure the recipe along with the associated tags.

Production data are to be transferred to the PLC, so it is necessary to synchronize with the PLC to prevent the data from accidentally overwriting each other. The tags are to be transferred to the PLC. Make the following settings for the recipe in the property view:

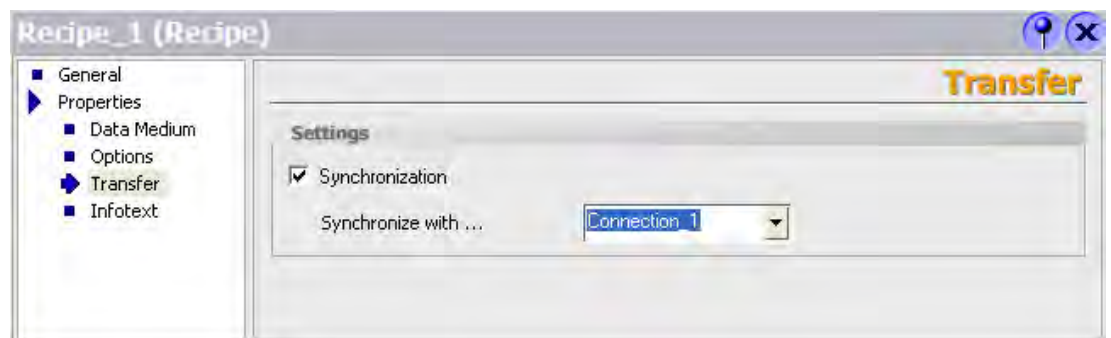
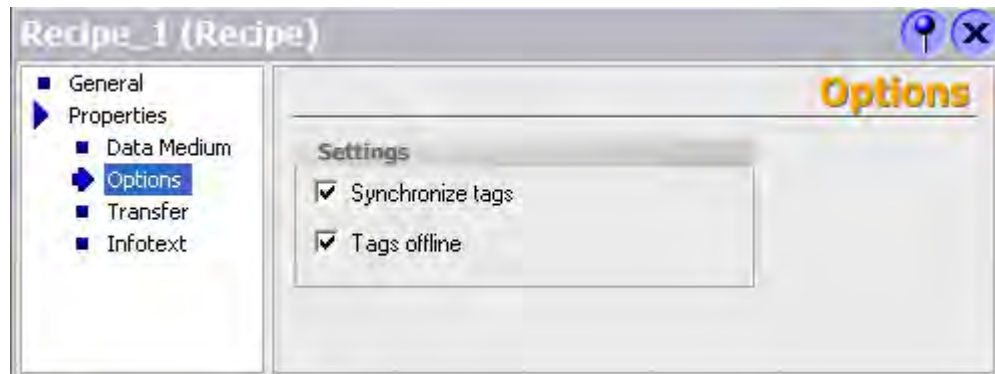

Depending on the extent of the recipe, you either configure a recipe view or create a recipe screen.

10.4.5 Scenario: Automatic production sequence

Objective

You want production to be executed automatically. The production data should be transferred directly to the PLC either from the data storage medium in the HMI device or from an external data storage medium. The production data do not have to be displayed.

Sequence

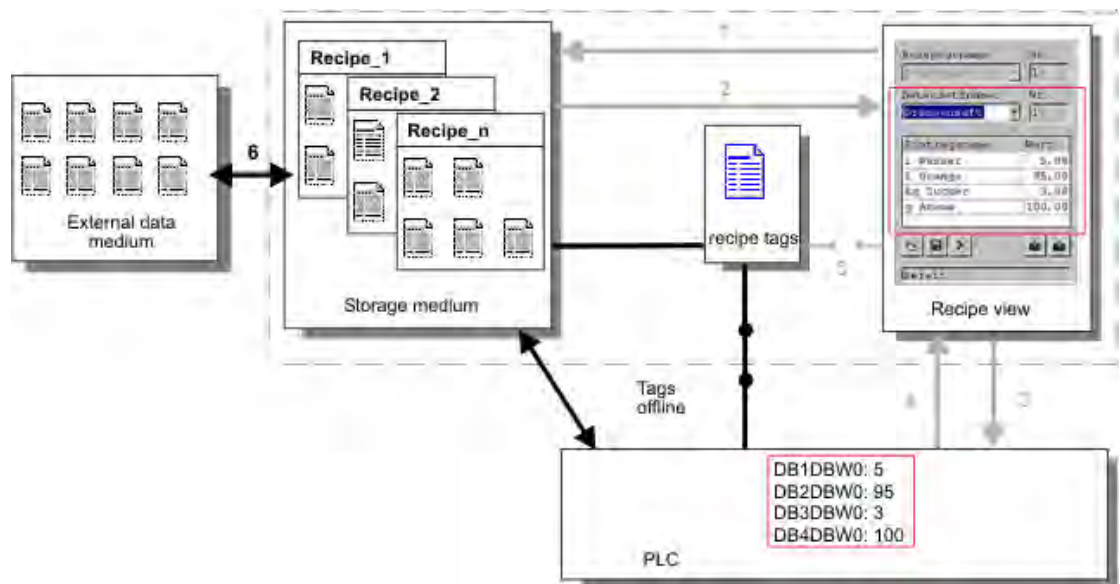

Production can be controlled using one or more "Scripts" which transfer production data records automatically to the PLC. The sequence can be checked using the return values of the utilized functions.

Configuration in WinCC flexible

You can implement the automatic production sequence with available system functions. The "ImportDataRecords" system function loads data records from a CSV file to the data medium. The "SetDataRecordTagsToPLC" system function transfers a data record from the data storage medium to the PLC.

10.5 Displaying recipes

10.5.1 Viewing and editing recipes in Runtime

Introduction

The WinCC flexible ES offers you two configuration options for viewing and editing recipes and their corresponding data records in Runtime on the HMI device:

- Recipe view
- Recipe screen

Recipe view

The recipe view is a screen object that is configured in the "Screens" editor. You can specify what operating function the recipe view will have in Runtime.

The screenshot displays the Recipe View configuration window. It features two rows of input fields. The first row has 'Recipe Name:' followed by a dropdown menu and 'No.:' followed by a text field containing '----'. The second row has 'Data Record Name:' followed by a dropdown menu and 'No.:' followed by a text field containing '----'. Below these fields is a table with two columns: 'Entry Name' and 'Value'. The table is currently empty. At the bottom of the window, there are several icons: a folder icon, a floppy disk icon, a close icon (X), and two bar chart icons. A 'Status Bar' is located at the very bottom of the window.

The recipe view shows recipe data records in tabular form. The recipe view is particularly useful if data records are small in size or if only a few values are to be modified.

Simple recipe view

On HMI devices which have displays smaller than 6" (e.g. OP 77B), the simple recipe view is used to display and edit recipes.

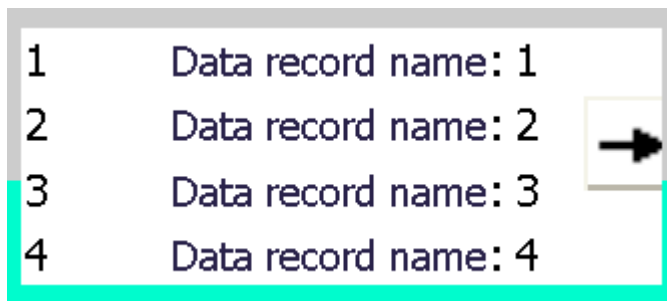

The simple recipe view consists of three areas:

- Recipe selection
- Recipe data record selection
- Recipe entries

In the simple recipe view, each area is shown separately on the HMI device. The simple recipe view always begins with the recipe selection.

Recipe screen

A recipe screen is a process screen with a customized input screen form that you create in the "Screens" editor by setting up input/output fields and other screen objects. This makes it possible for you to input parameter data in the context of machine visualization. The I/O fields for a recipe can be distributed over multiple recipe screens, which allows you a topical organization of recipe elements. The operating functions for the recipe screens must be specifically configured in the process screens.

Litre Water	50	Recipe name	No.:
Litre Concentrate	50	Orange	1
Kilo Sugar	30	Data record name	No.:
Gram Aroma	50	Nectar	2
		Save	Data to PLS
		Load	Data from PLS

10.5.2 Behavior of the recipe view in Runtime

Screen change

If you change to another screen and have not yet saved changes to the recipe data in the recipe view, you will be prompted to save the recipe data. The recipe name and the name of the recipe record are displayed to show which recipe data have not been saved yet.

If you change to a process screen that contains a recipe view with loaded recipe data, the recipe data will be automatically updated.

Operating the recipe view with softkeys

The recipe view can be operated with function keys, e.g. when the HMI device does not have touch functionality. System functions allow you to assign functions such as "Save data record" to the function keys of the HMI device.

10.6 Recipe data record administration

10.6.1 Recipe data record administration

Recipe data record administration

You can perform the following tasks in Runtime depending on the configuration:

- Create new recipe data records
- Copy recipe data records
- Edit recipe data records
- e-est recipe data records

You can edit recipe data records in the recipe view or screen, or import recipe data records from a CSV file.

Creating new recipe records

1. Select the recipe on the HMI device in which you want to create a new recipe data record.
2. Use the "Add data record" button in the recipe view or the corresponding button on the HMI device that is configured with this function.

A new data record with the next available number will be created. If you change the new data record number of an existing data record number, the data record is overwritten.

3. Enter a name for the recipe data records.

4. Enter the values for the recipe data records.
The configuration data may already contain default values for the recipe data record.
5. Use the "Save" button in the recipe view or the corresponding button on the HMI device that is configured with this function.

Result

The new recipe data records will be saved to the selected recipe. If the recipe data records already exists, a system alarm will be output to the screen.

Copying a recipe data record

You copy a recipe record by saving it under a new name.

1. Select the recipe on the HMI device in which you want to edit an existing recipe data record.
2. Select the recipe data record that you want to edit on the HMI device.
3. Assign a new name to the recipe data record.

As soon as you close the "Recipe data record" input field, the next free recipe data record number will be automatically assigned to the recipe data record. You may change the recipe data record number.

4. Use the "Save" button in the recipe view or the corresponding button on the HMI device that is configured with this function.

Result

The recipe data record is stored under the new name.

Modify recipe record

1. Select the recipe on the HMI device in which you want to edit an existing recipe data record.
2. Select the recipe data record that you want to edit on the HMI device.
3. Replace the old values with new ones.
4. Use the "Save" button in the recipe view or the corresponding button on the HMI device that is configured with this function.

Result

The modified values are applied to the recipe data record.

e-est recipe data record

1. Select the recipe on the HMI device in which you want to delete an existing recipe data record.
2. Select the recipe data record that you want to delete on the HMI device.
3. On the recipe view, select "Delete data record", or use the relevant button on the HMI device that is configured with this function.

Result

The recipe data record is deleted from the data medium of the HMI device.

10.6.2 Synchronizing a recipe data record

Introduction

In Runtime, differences between the indicated values and the actual values of the recipe tags may arise as a result of data input in recipe views or modification of recipe tags. Depending on the configuration, you can synchronize the values displayed in the recipe view with the recipe tags and values of the PLC. This synchronization is performed for each one of the recipe tags contained in the recipe data record.

Requirements

A recipe data record is displayed in the recipe view. The value of recipe tags can be changed by teach-ins.

Procedure

1. Use the "Synchronization with controller" button in the recipe view or the corresponding button configured with this function.

Result

- The system always updates the current value of the recipe view with the up-to-date recipe tag value.
- When the value shown in the recipe view is more recent than the current recipe tag value, the system writes this value to the recipe tag.

10.6.3 Read recipe data record from PLC

Introduction

You can read values from the PLC and write them to a recipe data record. For example, you can do this in machine teach-in mode in order to save the positioning data of axes as a recipe data record.

The read values are written to the recipe record that is currently displayed on the HMI device.

Procedure

1. Select the recipe on the HMI device.
2. On the HMI device, select the recipe data record whose values you want to read from the PLC.
3. Use the "Read from PLC" button in the recipe view or the corresponding button on the HMI device that is configured with this function.
4. Use the "Save" button in the recipe view or the corresponding button on the HMI device that is configured with this function.

Result

The values are read from the PLC, visualized on the HMI device and saved to the recipe data record.

10.6.4 Transfer recipe record to PLC

Introduction

You can edit recipes offline or online.

- Offline: The data are transferred to the PLC after the relevant command is executed.
- Online: The data are transferred immediately to the PLC

In the recipe view, data are always edited offline. The configuration of the recipe screen determines whether the recipe data are edited offline or online.

When you edit data offline, you have to transfer the changed data to the PLC.

Procedure

1. Select the recipe on the HMI device.
2. On the HMI device, select the recipe data record whose values you want to transfer to the PLC.
3. Use the "To PLC" button in the recipe view or the corresponding button on the HMI device that is configured with this function.

Result

The values of the recipe record are transferred to the PLC.

10.6.5 Exporting and importing recipe data records

Introduction

Based on your configuration, you can either export recipe data record to a CSV file or import data records from a CSV file. The extent to which you can influence these processes is determined by the project configuration. Various input boxes may be configured on the user interface:

- Input of the CSV file path
- Selection of the recipe data records for export
- Overwriting an existing CSV file

Export recipe data record

Requirements

Export functions are configured.

Procedure

1. Customize the export settings on the user interface of the HMI device. You can set the CSV file path, for example.
2. Press the button or the key on the HMI device configured with the "Export recipe records" function.

Result

The recipe data records are exported to a CSV file.

Note

New data records created in Runtime can be exported to an external file.

Importing recipe records

Requirements

Import functions are configured.

Procedure

1. Customize the import settings on the user interface of the HMI device. For example, you can set the CSV file path.
2. Use the button or the key on the HMI device which is assigned the "Import recipe records" function.

Result

The recipe data records are imported. If the structure of the CSV file is different from the recipe structure, deviations are treated as follows:

- Any additional values in the CSV file will be rejected.
- If the CSV file contains values of the wrong data type, the configured default value is set in the recipe record.

Example:

The CSV file contains values that show the tank contents and were input as floating point numbers. However, the corresponding recipe tag expects an integer value. In this case, the system discards the imported value and uses the configured default.

- The system also applies the configured default value to the recipe data record if the CSV file contains an insufficient number of values.

10.6.6 Reactions to modifications of the recipe structure

Introduction

Engineering for the purpose of machine retrofitting may also influence the recipe structure. Previously created recipe data records can nevertheless continue to be used.

Effects

If the structure of the recipe record is different from the defined address ranges in the PLC, deviations are handled as follows:

- Any additional values in the recipe record will be rejected.
- If the recipe record contains values of the incorrect data type, the default will be used in the recipe record.

Example: The recipe record contains values that show the tank contents and were input as floating point numbers. However, the corresponding recipe tag expects an integer value. In this case, the transferred value is rejected and the default value is used.

The system also applies the default value to the recipe data record if the recipe data record contains an insufficient number of values.

Caution

When a tag is renamed, the assignment is lost.

10.7 Example

10.7.1 Example: Creating a recipe

Task

In this example, you create three recipes for a fruit juice mixing machine. The fruit juice mixing machine is to be used to produce orange, apple, and tropical fruit e-estab, based on mixing ratios for fruit drinks, nectar, and juice.

Settings

The settings relate to an HMI device which is connected to a SIMATIC S7-300 or SIMATIC S7-400 via MPI.

In this example, you need the following tags, flags, recipes, and recipe data record values:

Tags:

Name	PLC connection	Address	Type
Liter water	Yes	DB 120, DBW 0	Integer
Liter concentrate	Yes	DB 120, DBW 4	Integer
Kilo sugar	Yes	DB 120, DBW 8	Integer
Gram flavoring	Yes	DB 120, DBW 12	Integer

Flag:

Name	Address
Data record	DB 100, DBW 0

Recipe (basic settings):

Recipe element	Associated tag
Liter water	Liter water
Liter concentrate	Liter concentrate
Kilo sugar	Kilo sugar
Gram flavoring	Gram flavoring

Recipe data record values:

Data record name	Liter water	Liter concentrate	Kilo sugar	Gram flavoring
Fruit drink	30	70	45	600
Nectar	50	50	10	300
Juice	5	95	3	100

Procedure

1. Create the following tags with the settings indicated earlier: Liter water, Liter concentrate, Kilo sugar and Gram e-establi.
2. Create the orange, apple, and tropical fruit recipes with the settings indicated above.

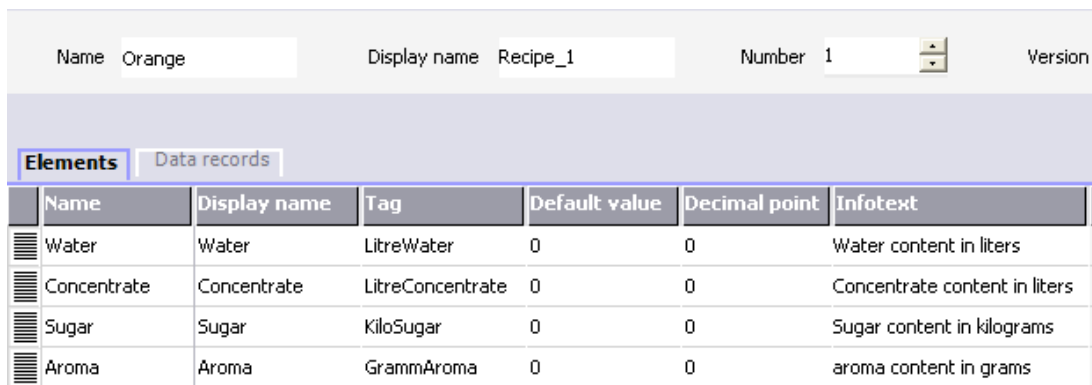

Figure 10-1 Recipe with recipe elements

3. Configure each recipe in such a way that you can edit the recipe data records on a recipe screen. The values of the recipe tags should not be transferred automatically to the PLC.
4. Create the data records indicated above in each recipe. Enter the values indicated above in each of the data records.

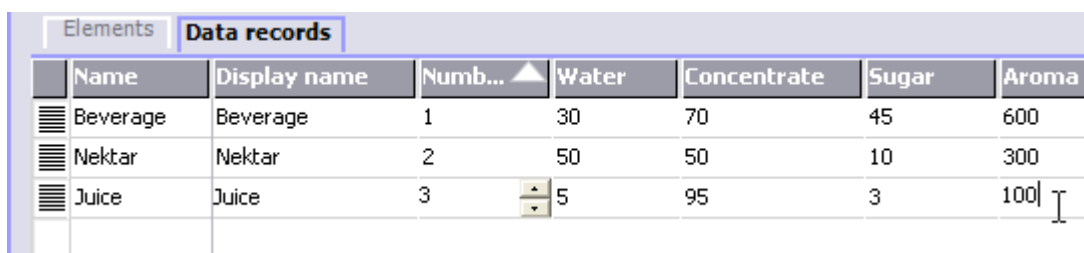

Figure 10-2 Recipe with recipe data record values

Result

The orange, apple, and tropical fruit e-esta recipes have been created. In the "Configure recipe screen" example, you create a recipe screen in which you create an individual input screen form.

10.7.2 Example: Configuring a recipe screen

Task

In this example, you create a recipe screen for the visualization of values of the fruit juice mixing machine. You use a recipe view to select the recipes and their associated recipe data records. You should be able to load and save the values of the recipe data records and transfer them to and read them from the PLC.

Requirements

The "Creating a recipe" sample application has been carried out.

The "Fruit juice mixing machine" process screen has been created and is opened.

Settings

In this example, you need the following tags and buttons with the indicated settings:

Tags:

Name	PLC connection	Type
RecipeNumber	No	Integer
Data record number	No	Integer

Buttons:

Labeling	Configured event	System function
Load	Press	LoadDataRecord
Save	Press	SaveDataRecord
Data to PLC	Press	Write data record tags to PLC
Data from the PLC	Press	GetDataRecordTagsFromPLC

Procedure

1. Drag-and-drop the "Liter water", "Liter concentrate", "Kilo sugar", and "Gram e-establi" tags from the object view to the "Fruit juice mixing machine" process screen.
Four I/O fields are created and linked by the specified tags.
2. Configure a recipe view containing only the drop-down lists for the recipe name and data record name. Link the recipe view to the "RecipeNumber" and "DataRecordNumber" (recipe data record number) tags in the "General" group in the property view.
3. Assign the settings described above to each one of the four buttons. Transfer each "RecipeNumber" and "DataRecordNumber" tag as a parameter for the recipe number and recipe data record number.

Result

In Runtime, you can select the recipe and the associated recipe data record from the recipe view. Click "Load" to load the recipe data record values and display these in the configured I/O fields. Click "To PLC" to write the recipe data record values to the associated tags and to transfer the recipe data record values to the PLC.

Maintenance/Service

11.1 Clean screen/keyboard foil

11.1.1 General information

Introduction

Clean the HMI device screen or keyboard foil at regular intervals. Use a damp cloth.



Caution

Cleaning the keyboard foil of key devices

Clean the HMI device after it has been switched off. This ensures that functions are not inadvertently triggered by touching the keys or the touch screen.

Cleaning agents

Use only water with liquid soap or a screen cleaning foam. Never spray the cleaning agent directly onto the screen. Apply it to a cloth. Never use aggressive solvents or scouring powder.

11.1.2 Notes on the touch panel

Clean screen

Only applies to HMI devices with a touchscreen:

The HMI device touchscreen can be cleaned when switched on and when operating normally if touchscreen input has been suppressed by means of an appropriately configured operating element (Clean Screen). After the Clean Screen function has been activated, all input via the touchscreen operating elements is deactivated for a defined period of time. The time remaining until the end of operating suppression is indicated by a progress bar.

Notice

Suppressing operating elements

Only clean the screen during operation when Clean Screen is activated. Note the end of operating suppression by the Clean Screen.

Otherwise, incorrect operations may be initiated.

Protective foil

A protective foil is available for the touchscreens on HMI devices. The necessary ordering information is provided in the Siemens Catalog ST 80. The protective foil is not part of the material supplied with the HMI device.

The self-adhesive foil prevents the screen from being scratched and soiled. In addition, the matte surface of the foil reduces reflections in poor lighting conditions.

The protective foil can be removed as necessary without leaving any adhesive residue on the screen.

Caution

Remove protective foil

Never use sharp or pointed tools, such as a knife, to remove the protective foil. This may damage the touchscreen.

See also

General information (Page 11-1)

11.2 Replacing the optional backup battery

Function of the backup battery

An optional backup battery is available for the HMI device. The battery ensures that in the event of a power failure, the HMI device's internal hardware clock continues to run.

Under normal operating conditions, the battery has a service life of approx. four years. It is not supplied with the HMI device.

Supply source

The battery can be ordered from the Siemens spare parts service. It is shipped ready for installation with a cable and connector. Please refer to the Siemens Catalog ST80 for the order number.

Procedure



Caution

Change the battery while power is still being supplied to ensure the internal hardware clock continues to run.

The battery must be changed by a properly qualified person.

Before replacing the battery, refer to the ESD Guidelines.

1. Unplug the battery cable connector from the two-pin socket in the HMI device.
2. In the case of the MP 270B 10", TP 270 10" or OP 270 10", the battery is normally secured at the back of the HMI device with two cable ties, In the case of the MP 270B 6", TP 270 6" or OP 270 6", one cable tie is used. Cut the cable ties, using pliers for instance, and remove the empty battery.
3. In the case of the MP 270B 10", TP 270 10" or OP 270 10", secure the battery at the back of the HMI device with two cable ties. In the case of the MP 270B 6", TP 270 6" or OP 270 6", use one cable tie.
4. Insert the battery lead connector back into the socket. The plug is coded to prevent reversed poling.

General information

Please observe the following safety notes to ensure correct handling and disposal of lithium batteries:



Warning

The lithium battery can explode if not handled properly. The lithium battery should:

- never be charged
- not be opened
- not be short-circuited
- be safeguarded against reversed poling
- not be exposed to temperatures in excess of 100 °C
- be protected against direct sunlight

Do not allow condensation to form on batteries.

If you have to ship a battery, ensure compliance with the Dangerous Goods Ordinance for the shipping agent concerned (coding obligation).

Treat used lithium batteries as special waste. Pack them separately in leakproof plastic bags for disposal.

See also

ESD guidelines (Page A-2)

Interfaces (Page 4-6)

Backup battery (Page 1-12)

Technical data

12.1 Dimension drawings

12.1.1 MP 270B 10" Touch, TP 270 10" dimensions

Unit dimensions

HMI device dimensions, MP 270B 10" Touch and TP 270 10":

The two devices only differ on the front by their e-establ ("SIMATIC MULTI PANEL" on the MP 270B 10" Touch, "SIMATIC PANEL" on the TP 270 10").

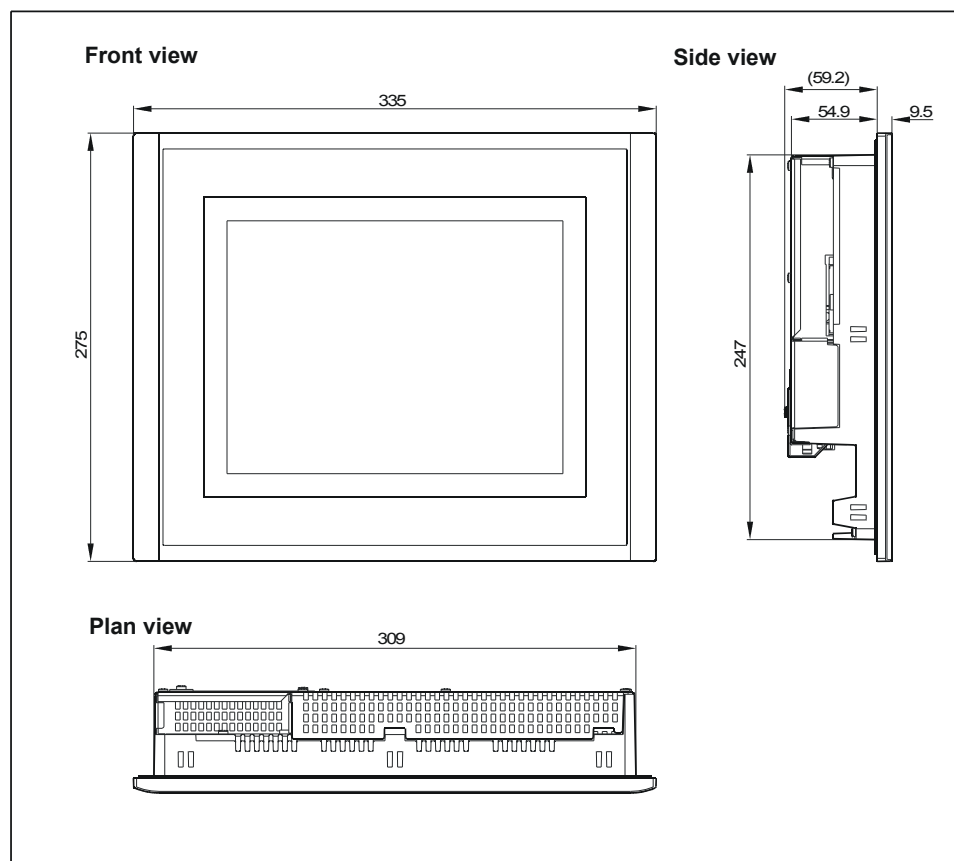

Figure 12-1 MP 270B 10" Touch and TP 270 10" dimensions:

12.1.2 MP 270B 6" Touch, TP 270 6" dimensions

Unit dimensions

HMI device dimensions, MP 270B 6" Touch and TP 270 6":

The two devices only differ on the front by their e-establ ("SIMATIC MULTI PANEL" on the MP 270B 6" Touch, "SIMATIC PANEL" on the TP 270 6").

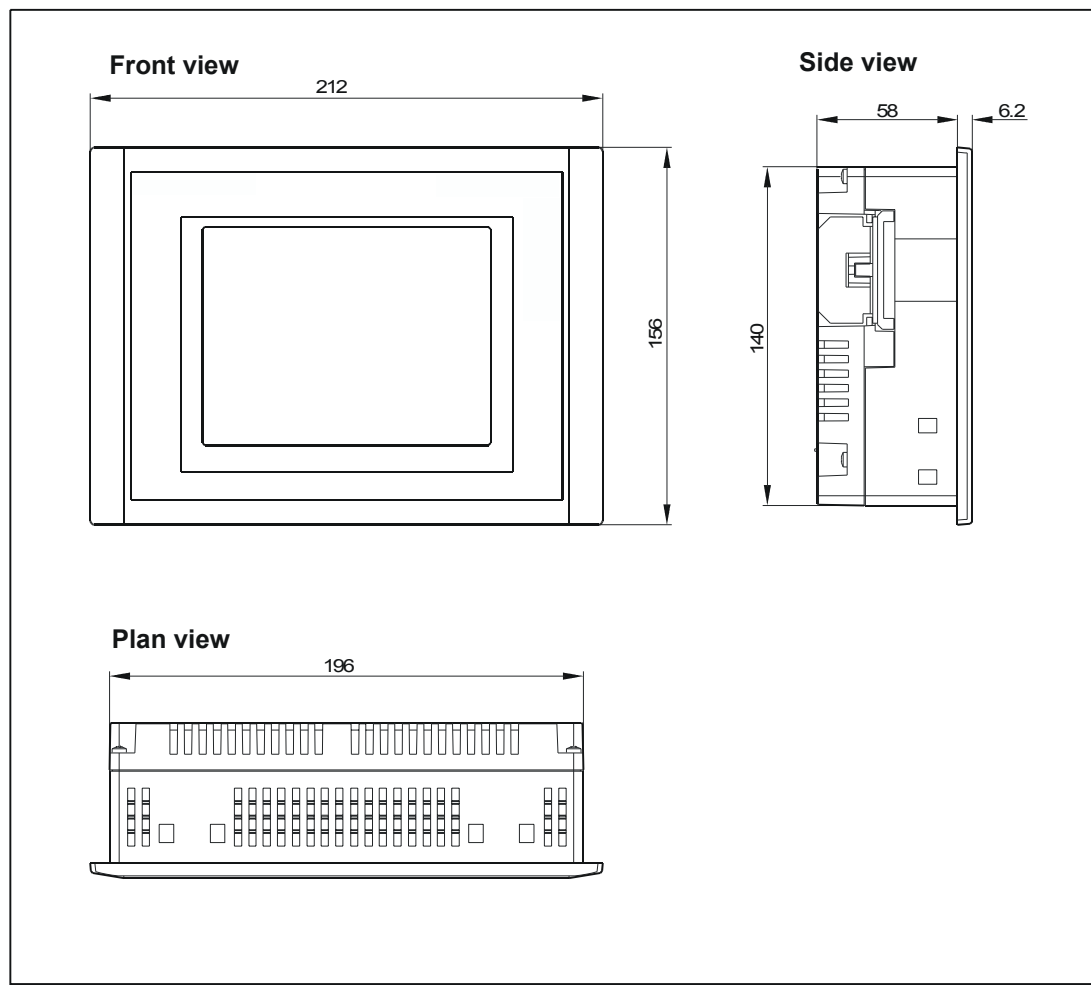

Figure 12-2 MP 270B 6" Touch and TP 270 6" dimensions:

12.1.3 Dimensions, MP 270B 10" Keys, OP 270 10"

Unit dimensions

MP 270B Keys and OP 270 10" HMI device dimensions:

The two devices only differ on the front by their e-establ ("SIMATIC MULTI PANEL" on the MP 270B 10" Keys, "SIMATIC PANEL" on the TP 270 10").

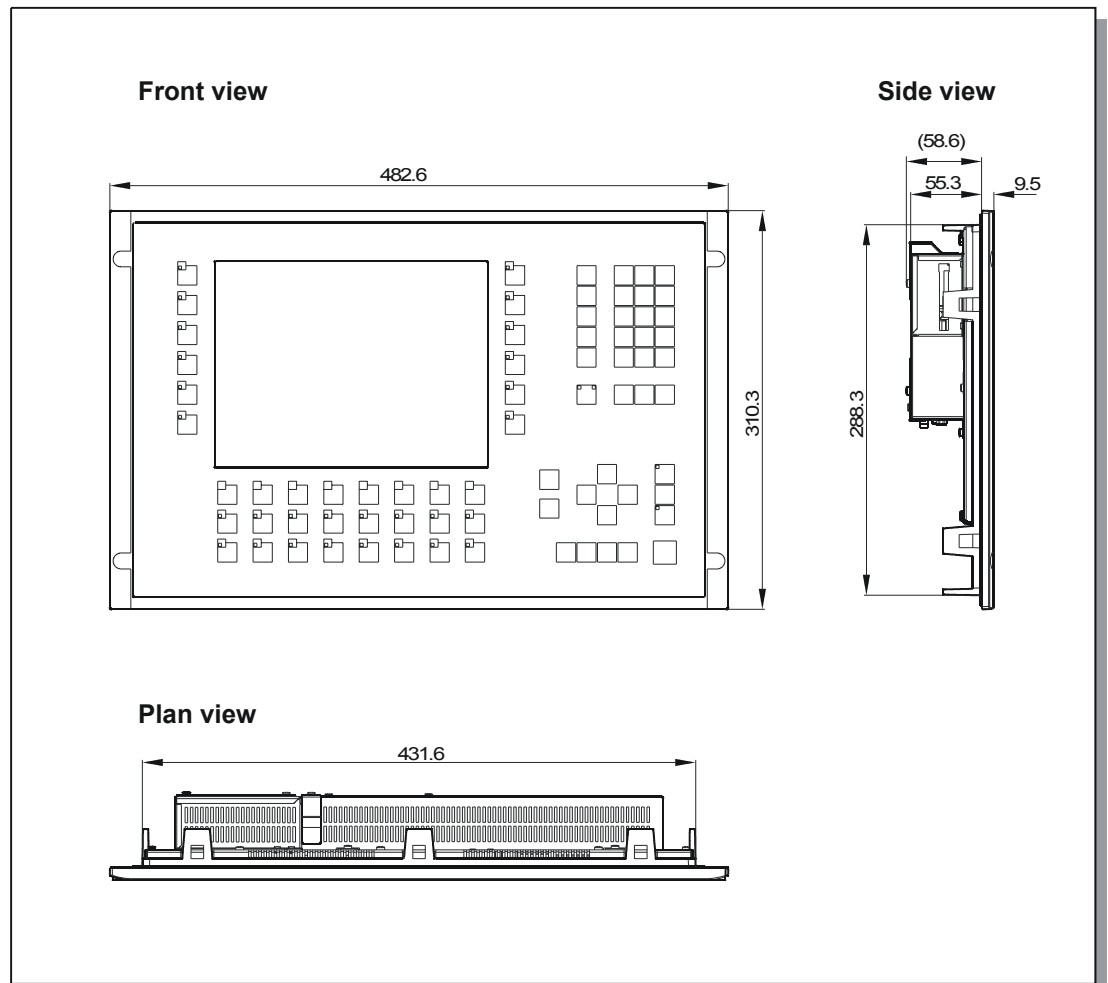

Figure 12-3 Dimensions of the MP 270B 10" Keys and OP 270 10"

12.1.4 Dimensions, OP 270 6"

Unit dimensions

OP 270 6" device dimensions

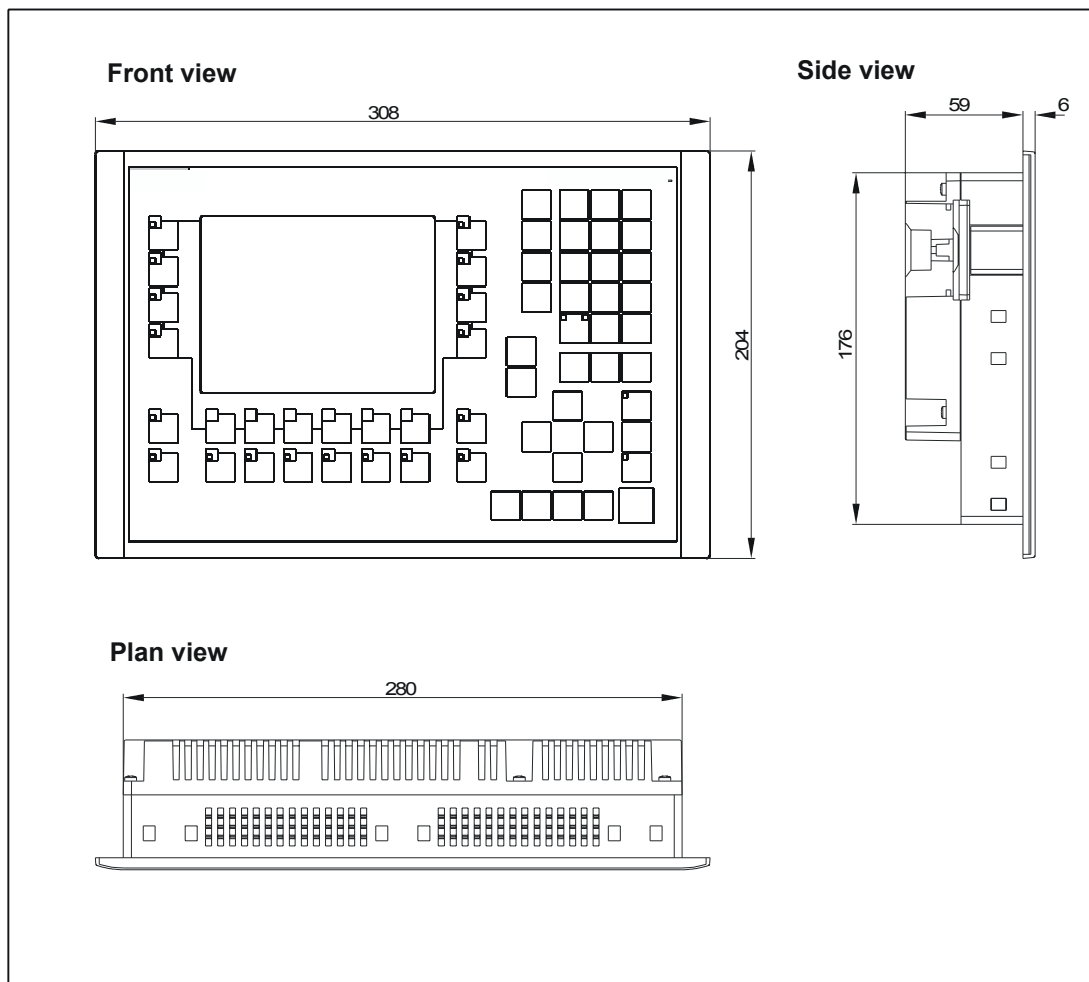

Figure 12-4 OP 270 6" dimensions

12.2 Technical data

Technical data

Housing	MP 270B 10" Keys / OP 270 10"	MP 270B 10" Touch / TP 270 10"	OP 270 6"	MP 270B 6" Touch / TP 270 6"
External dimensions (W x H) in mm	483 x 310	335 x 275	308 x 204	212 x 156
Installation cutout (W x H) in mm	436 ⁺¹ x 295 ⁺¹	310 ⁺¹ x 248 ⁺¹	282 ⁺¹ x 178 ⁺¹	198 ⁺¹ x 142 ⁺¹
Installation depth	55 mm		59 mm	
Degree of protection				
Front	IP65/NEMA 4x Indoor/NEMA 12			
Rear panel	IP20			
Weight	Approx. 6 kg	Approx. 4,5 kg		Approx. 1 kg

Processor

Type	64 bit RISC CPU
------	-----------------

Memory

	MP 270B	OP 270 / TP 270
Memory for configuration	4 MB	2 MB
Bulk storage		
Slot for CF card	e.g. ATA Flash card	
Slot for PC card	E.g. <ul style="list-style-type: none"> • ATA Flash card • SRAM cards • NE 2000-compatible Ethernet card 	

Software

Operating system	Microsoft Windows CE
------------------	----------------------

Technical data

12.2 Technical data

Color display	MP 270B 10" Keys	MP 270B 10"/6" Touch	OP 270 10" / OP 270 6"	TP 270 10" / TP 270 6"
Type	TFT LCD	TFT LCD with touch panel	CSTN LCD	CSTN LCD with touch panel
Active screen diagonal	10,4 "	10,4 " / 5,7 "	10,4 " / 5,7 "	10,4 " / 5,7"
Resolution (pixels)	640 x 480 (VGA)	640 x 480 (VGA) / 320 x 240 (QVGA)	640 x 480 (VGA) / 320 x 240 (QVGA)	
Possible colors	256			
Back-lighting	CCFL tubes			
Half brightness life ¹⁾	50000 h	50000 h	60000 h / 40000 h	60000 h / 40000 h

- 1) Time period the brightness of the lighting tube only achieves 50% of its original value. The specified value depends on the operating temperature.

Keyboard	MP 270B 10" Keys / OP 270 10"	OP 270 6"
Type	Membrane keyboard	
System keys with dedicated functions	38 (3 with LEDs)	36 (3 with LEDs)
Configurable function keys		
Number	36 (28 with LEDs)	24 (18 with LEDs)
for local assignment	20	14
Labeling	System-specific with e-establish strips	System-specific with e-establish strips

Acoustic acknowledgement	MP 270B Touch / TP 270
In the case of touch control	× (can be disabled)

Power supply	OP 270 6" / TP 270 6"	MP 270B 6" Touch	MP 270B / OP 270 10" / TP 270 10"
Rated voltage	+24 V DC		
Permissible range	+24 V DC -15%, +20%		
Max. permissible transients	35 V (500 msec)		
Time between two transients	Min. 50 s		
Power consumption			
Typical	Approx. 0,6 A	Approx. 0,8 A	Approx. 0,9 A
Max. constant current	Approx. 0,9 A	Approx. 1,0 A	Approx. 1,0 A
Power on current surge I ² t	Approx. 0.5 A ² s	Approx. 0.5 A ² s	Approx. 0.5 A ² s
Fuse, internal	Electronic		

Backup battery (option)	
Type	Lithium battery (Sonnenschein SL2361)
Voltage/Capacity ²⁾	3.6 V / approx. 1.5 Ah
Service life	Approx. 4 years

2) All rights reserved

Network connection	MP 270B	OP 270 / TP 270
Type	1 x Ethernet (10/100 Mbit)	Optional via NE 2000-compatible Ethernet card

Ambient conditions	OP 270 6" / TP 270 6" MP 270B 6" Touch	MP 270B / OP 270 10" / TP 270 10"
Installation position	Vertical	Vertical
Max. permissible angle of inclination without external ventilation	±35°	±35°
Max. permissible ambient temperature		
Operation		
Vertical installation		
Installation angled from the perpendicular to max. 35°	0...+50 °C 0...+35 °C	0...+50 °C 0...+40 °C
Shipping, storage	-20...+60 °C	-20...+60 °C
Shock loading		
Operation		15 g / 30 ms
Shipping, storage		25 g / 6 ms
Vibration		
Operation		0,075 mm (10 - 58 Hz) 1 g (58 - 150 Hz)
Shipping, storage		3.5 mm (5 - 9 Hz) 1 g (9 - 500 Hz)
Barometric pressure		
Operation		795...1080 hPa
Shipping, storage		660...1080 hPa

Ambient conditions	MP 270B Keys / OP 270	MP 270B Touch / TP 270
Relative humidity		
Operation, transport, storage	Max. 90%, no condensation	Max. 85%, no condensation

12.3 EMC requirements

EMC requirements

Compliance of the named products with the regulations of Directive 89/336 EEC is verified by conformance with the following standards:

Noise immunity	Norms	
Static discharge (contact discharge/air discharge)	EN 61000-4-2	6 kV/8 kV
RF irradiation	EN 61000-4-3	10 V/m, 80% AM, 1 kHz
Pulse modulation	EN 61000-4-3	900 MHz \pm 5 MHz 10 V/m _{eff.} , 50% ED, 200 Hz
RF conduction	EN 61000-4-6	150 kHz - 80 MHz 10 V, 80% AM, 1 kHz
Burst interference	EN 61000-4-4	
Supply lines		2 kV
Process data lines		2 kV
Signal lines		1 kV
Surge coupling	EN 61000-4-5	1 kV with choke,
Power supply cable		Type DEHNrail (Order No. 901 104) 2 kV with choke, Type DEHNrail (Order No. 901 104)
Magnetic fields	EN 61000-4-8	30A/m 50/60 Hz
Radio interference		
Radio interference level complying to EN 55011		Class A

12.4 Interfaces

IF1A

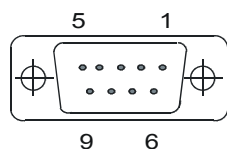

Table 12-1 9-pin Sub-D plug (pin)

Pin	RS 232
1	-
2	RXD
3	TXD
4	-
5	GND
6	-
7	RTS
8	CTS
9	-

IF1B

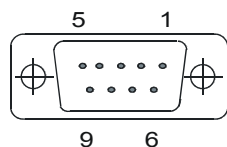

Table 12-2 9-pin Sub-D socket (configuration via switch)

Pin	RS 422	RS 485 / PROFIBUS-DP / MPI
1		N.C.
2		N.C.
3	TXD+	Data B
4	RXD+	RTS-AS
5		GND (floating)
6		+5 V (floating)
7		N.C.
8	TXD-	Data A
9	RXD-	-

IF2

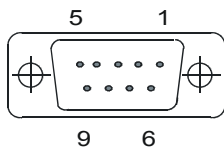

Table 12-3 9-pin Sub-D plug (pin)

Pin	RS 232
1	DCD
2	RXD
3	TXD
4	DTR
5	GND
6	DSR
7	RTS
8	CTS
9	N.C.

Ethernet interface (MP 270B only)

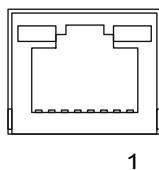
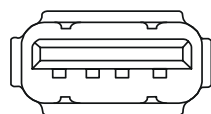

Table 12-4 RJ45 plug connection

Pin	RJ45
1	10BaseT: TX+
2	10BaseT: TX-
3	10BaseT: RX+
4	-
5	-
6	10BaseT: RX-
7	-
8	-

USB interface



1

Table 12-5 USB standard plug

Pin	USB
1	+5V
2	+5V
3	USB-DM
4	USB-DP
5	0V
6	0V

Appendix

A.1 Certificates and Directives

A.1.1 Approvals

Approvals

As of the date of delivery, the following approvals have been granted or their application is pending. Please refer to the rating plate on the back of the HMI device for identification.



Warning

Personal injury and equipment damage can occur.

Personal injury and equipment damage can occur in hazardous areas if a plug connection is disconnected from the HMI device while the system is running.

In hazardous areas, turn off the power to the HMI device when disconnecting the connectors.

DO NOT DISCONNECT WHILE CIRCUIT IS LIVE UNLESS LOCATION IS KNOWN TO BE NON HAZARDOUS.

Approvals	
UL approval	UL Recognition Mark ¹⁾ Underwriters Laboratories (UL) complying with Standard UL 508, File E 116536
UL approval	In accordance with the UL/CSA Approval Agreement
FM approval	FM approval Complying with Factory Mutual Approval Standard Class Number 3611 Hazardous (classified) Locations Class I, Division 2, Group A, B, C, D

- 1) The UL and CSA file numbers are dependent on the production site. The numbers specified here change according to the change of production site.

A.1.2 ESD guidelines

What does ESD mean?

Virtually all present-day, electronic modules incorporate highly integrated MOS devices or components. For technological reasons, these electronic components are very sensitive to overvoltage and, consequently, to electrostatic discharge. As a result, they are identified as follows:

- **EGB** – Elektrostatisch Gefährdeten Bauelemente/Baugruppen
- **ESD** – Electrostatic Sensitive Devices

The following symbol on plates on cabinets, mounting racks and packages draws attention to the use of ESD and, thus, to the contact sensitivity of the assemblies concerned:



Figure A-1 Symbol for ESD

ESDs may be destroyed by voltages and energies that are undetectable to a human. Voltages of this kind occur as soon as a device or an assembly is touched by a person who is not grounded against static electricity. ESDs exposed to such over voltages may not immediately be detected as defective. In the majority of cases, faulty e-establishment may occur only after a long period of operation.

Precautions against electrostatic discharge

Most plastics are capable of carrying high charges. It is therefore imperative that they be kept away from ESDs.

When handling electrostatic sensitive devices, make sure that persons, workplaces and packages are properly grounded.

Handling ESD assemblies

A general rule is that ESDs should be touched only when necessary, for example, when maintenance is required.

Only touch devices if

- You are grounded by permanently wearing an ESD wrist strap.
- You are wearing ESD shoes or ESD shoe-grounding protection straps in conjunction with an ESD floor.

Before you touch an electronic assembly, your body must be discharged. The simplest way of doing this is to touch a conductive, grounded object immediately beforehand (e.g. bare metal parts of a cabinet, water pipe etc.).

ESDs should not be brought into contact with charge-susceptible and highly insulating materials such as plastic films, insulating table tops and items of clothing containing synthetic fibers.

Assemblies should be deposited only on conductive surfaces, e.g. tables with an ESD coating, conductive ESD cellular material, ESD bags, ESD shipping containers.

Do not place ESDs near visual display units, monitors or television sets (minimum distance to screen > 10 cm).

Never touch ESDs so that contact is made with module connections or conductor rails.

Measuring ESD assemblies

Perform measurements on ESD assemblies only when:

- The measuring instrument is grounded (e.g. by means of a grounded conductor).
- The measuring head has been briefly discharged before measurements are made with a potential-free measuring instrument (e.g. by touching a bare metal control cabinet).

When soldering, use only grounded soldering irons.

Shipping ESD assemblies

Always store and ship assemblies and devices in conductive packing (e.g. metal-plated plastic boxes, metal boxes).

- Packing ESD

If packing is not conductive, ESDs must be conductively wrapped before they are packed. You can use, for example, conductive foam rubber, ESD bags, domestic e-establ foil or paper (never use plastic bags or foils).

- ESD with fitted battery

With assemblies containing fitted batteries, make sure that the conductive packing does not come into contact with batteries or short-circuit them. If necessary, cover the connectors beforehand with suitable insulating material.

A.2 System alarms

Introduction

System alarms on the HMI device provide information on internal conditions of the HMI device and PLC.

The following is an overview of when system alarms occur, their causes and the remedies available.

Note

System alarms are only displayed when an alarm window has been configured, System alarms are issued in the language currently set on the HMI device.

System alarm parameters

The system alarms may contain parameters which are coded but which are relevant with respect to the cause of an error. They provide a reference to the source code from the runtime software. These parameters are issued after the text "Error code:".

System alarm parameters

Number	Effect/cause	Remedy
10000	The print job cannot be started or was e-established due to an unknown cause. The printer is not configured correctly. Or There are no rights for a network printer. A power failure occurred during data transfer.	Check the printer settings, cable connections and power supply. Setup the printer again. Request rights for the network printer. If an error occurs repeatedly, contact the hotline.
10001	No printer is installed or a default printer has not been selected.	Install a printer and/or select it as the default printer.
10002	The graphics buffer for printing is full. Up to two graphics are buffered.	Wait before triggering print jobs.
10003	Graphics can be buffered again.	-
10004	The buffer for printing lines in text mode (e.g. alarms) is full. Up to 1000 lines are buffered.	Wait before triggering print jobs.
10005	Text lines can be buffered again.	-
10006	The Windows printing system reports an error. Refer to the printed text and the error number to determine the possible causes. Nothing is printed or the printout is incorrect.	Repeat the action if necessary.
20010	An error has occurred in the specified script line. The execution of the script was therefore aborted. Note the system alarms that may have occurred prior to this.	Select the specified script line in the configuration. Ensure that the tags used are the allowed types. Check system functions for the correct number and types of parameters.
20011	An error has occurred in a script that was called by the specified script. The execution of the script was therefore aborted in the called script. Note the system alarms that may have occurred prior to this.	In the configuration select the script that has been called directly or indirectly by the specified script. Ensure that the tags used are the allowed types. Check system functions for the correct number and types of parameters.
20012	The configuration data is inconsistent. The script could therefore not be generated.	Recompile the configuration.
20013	The script components from WinCC flexible runtime are not correctly installed. Therefore, no scripts can be executed.	Reinstall WinCC flexible runtime.
20014	The system function returns a value that is not written in any return tag.	Select the specified script in the configuration. Check whether the script name has been assigned a value.
20015	Too many scripts have been triggered in quick succession. When more than 20 scripts are queued for processing, any subsequent scripts are rejected. In this case, the script indicated in the alarm is not executed.	Find what is triggering the scripts. Extend the times, e.g. the polling time of the tags which trigger the scripts.
30010	The tag could not accept the function result, e.g. when it has exceeded the value range.	Check the tag type of the system function parameter.

Number	Effect/cause	Remedy
30011	A system function could not be executed because the function was assigned an invalid value or type in the parameter.	Check the parameter value and tag type of the invalid parameter. If a tag is used as a parameter, check its value.
40010	The system function could not be executed since the parameters could not be converted to a common tag type.	Check the parameter types in the configuration.
40011	The system function could not be executed since the parameters could not be converted to a common tag type.	Check the parameter types in the configuration.
50000	The HMI device is receiving data faster than it is capable of processing. Therefore, no further data is received until the data currently available has been processed. Data exchange then resumes.	-
50001	Data exchange resumes.	-
60000	This alarm is generated by the function "ShowSystemAlarm". The text to be displayed is transferred to the function as a parameter.	-
60010	The file could not be copied to the defined path because one of the two files is currently open or the source/target path is not available. It is possible that the Windows user has no access rights to one of the two files.	Restart the system function or check the paths of the source/target files. Using Windows NT/2000/XP: The user executing WinCC flexible Runtime must be granted access rights for the files.
60011	An attempt was made to copy a file to itself. It is possible that the Windows user has no access rights to one of the two files.	Check the path of the source/target file. When using Windows NT/2000/XP with NTFS: The user executing WinCC flexible Runtime must be granted access rights for the files.
70010	The application could not be started because it could not be found in the path specified or there is insufficient memory.	Check whether the application exists in the specified path or close other applications.
70011	The system time could not be modified. The error message only appears in connection with area pointer "Date/Time PLC". Possible causes: <ul style="list-style-type: none"> An invalid time was transferred in the job mailbox. The Windows user does not have the right to modify the system time. If the first parameter in the system alarm is displayed with the value 13, the second parameter indicates the byte containing the incorrect value.	Check the time to be set. When using Windows NT/2000/XP: The user executing WinCC flexible Runtime must be granted the right to change the system time of the operating system.
70012	An error occurred executing the function "StopRuntime" with the option "Runtime and operating system". Windows and WinCC flexible Runtime are not closed. One possible cause is that other programs cannot be closed.	Close all programs currently running. Then close Windows.
70013	The system time could not be modified because an invalid value was entered. Incorrect separators may have been used.	Check the time to be set.

Number	Effect/cause	Remedy
70014	The system time could not be modified. Possible causes: <ul style="list-style-type: none"> An invalid time was transferred. The Windows user does not have the right to modify the system time. Windows rejects the setting request. 	Check the time to be set. When using Windows NT/2000/XP: The user executing WinCC flexible Runtime must be granted the right to change the system time of the operating system.
70015	The system time could not be read because Windows rejects the reading function.	-
70016	An attempt was made to select a screen by means of a system function or job. This is not possible because the screen number specified does not exist. or: a screen could not be generated due to insufficient system memory.	Check the screen number in the function or job with the screen numbers configured. Assign the numbers to a screen, if necessary.
70017	The date/time is not read from the area pointer because the address set in the PLC is either not available or has not been set up.	Change the address or set up the address in the PLC.
70018	Acknowledgment that the password list has been successfully imported.	-
70019	Acknowledgment that the password list has been successfully exported.	-
70020	Acknowledgment for activation of alarm reporting.	-
70021	Acknowledgment for deactivation of alarm reporting.	-
70022	Acknowledgment to starting the Import Password List action.	-
70023	Acknowledgment to starting the Export Password List action.	-
70024	The value range of the tag has been exceeded in the system function. The calculation of the system function will not be performed.	Check the desired calculation and correct it if necessary.
70025	The value range of the tag has been exceeded in the system function. The calculation of the system function will not be performed.	Check the desired calculation and correct it if necessary.
70026	No other screens are stored in the internal screen memory. No other screens can be selected.	-
70027	The backup of the RAM file system has been started.	-
70028	The files from the RAM have been copied in the Flash memory. The files from the RAM have been copied in the Flash memory. Following a restart, these saved files will be copied back to the RAM file system.	-
70029	Backup of the RAM file system has failed. No backup copy of the RAM file system has been made.	Check the settings in the "Control Panel > OP" dialog and save the RAM file system using the "Save Files" button in the "Persistent Storage" tab.

Number	Effect/cause	Remedy
70030	The parameters configured for the system function are faulty. The connection to the new PLC was not established.	Compare the parameters configured for the system function with the parameters configured for the PLC and correct them as necessary.
70031	The PLC configured in the system function is not an S7 PLC. The connection to the new PLC was not established.	Compare the S7 PLC name parameter configured for the system function with the parameters configured for the PLC and correct them as necessary.
70032	The object configured with this number in the tab order is not available in the selected screen. The screen changes but the focus is set to the first object.	Check the number of the tab order and correct it if necessary.
70033	An e-mail cannot be sent because a TCP/IP connection to the SMTP server no longer exists. This system alarm is generated only at the first attempt. All subsequent unsuccessful attempts to send an e-mail will no longer generate a system alarm. The alarm is regenerated when an e-mail has been successfully sent. The central e-mail component in WinCC flexible Runtime attempts, in regular intervals (1 minute), to establish the connection to the SMTP server and to send the remaining e-mail.	Check the network connection to the SMTP server and re-establish it if necessary.
70034	Following a disruption, the TCP/IP connection to the SMTP server could be re-established. The queued e-mail are then sent.	-
70035	The e-mail queue of the central component in WinCC flexible Runtime responsible for sending e-mail is full. The e-mail could therefore not be entered into the queue and therefore not sent. The cause may be a broken connection to the SMTP server or an overload resulting from too much e-mail traffic. This system alarm is generated only at the first attempt. The next system alarm is only generated when at least one e-mail has been successfully sent to the queue.	Check if <ul style="list-style-type: none"> the network connection still exists or the connection is overloaded (for example, due to reoccurring system alarms resulting from disruptions).
70036	No SMTP server for sending e-mail is configured. A connection to an SMTP server can therefore not be established and no e-mail can be sent. The system alarm is generated by WinCC flexible Runtime the first time an attempt is made to send an e-mail.	Configure an SMTP server: In WinCC flexible Engineering System using "Device settings > Device Settings". In the Windows CE operating system using "Control Panel > Internet Settings > Email > SMTP Server"
70037	An e-mail cannot be sent for unknown reasons. The contents of the e-mail are lost.	Check the e-mail parameters (recipient, etc.).
70038	The SMTP server has rejected sending or forwarding an e-mail because the domain of the recipient is unknown to the server or because the SMTP server requires authentication. The contents of the e-mail are lost.	Check the domain of the recipient address or deactivate the authentication on the SMTP server if possible. SMTP authentication is currently not used in WinCC flexible Runtime.
70039	The syntax of the e-mail address is incorrect or contains illegal characters. The contents of the e-mail are discarded.	Check the e-mail address of the recipient.

Number	Effect/cause	Remedy
70040	The syntax of the e-mail address is incorrect or contains illegal characters.	-
80001	The specified log is filled to the maximum (in percent) and must be stored elsewhere.	Store the file or table by executing a 'move' or 'copy' function.
80002	A line is missing in the specified log.	-
80003	The copying process for logging was not successful. In this case, it is also advisable to check any subsequent system alarms.	-
80006	Logging is not possible, resulting in a permanent loss of the functionality.	In the case of databases, check whether the corresponding data source exists and restart the system.
80009	A copying action has been completed successfully.	-
80010	The storage location was incorrectly entered in WinCC flexible, resulting in a permanent loss of the functionality.	Configure the storage location for the respective log again and restart the system when full functionality is required.
80012	Log entries are stored in a buffer. If the values are read to the buffer faster than they can be physically written (using a hard disk, for example), overloading may occur and recording is then stopped.	Archive fewer values. or: Increase the logging cycle.
80013	The overload status no longer applies. Archiving resumes the recording of all values.	-
80014	The same action was triggered twice in quick succession. Since the process is already in operation, the action is only carried out once.	-
80015	This system alarm is used to report DOS or database errors to the user.	-
80016	The logs are separated by the system function "CloseAllLogs" and the incoming entries exceed the defined buffer size. All entries in the buffer will be deleted.	Reconnect the logs.
80017	The incoming entries exceed the defined buffer size. This can be caused, for example, by several copying actions being activated at the same time. All copy jobs will be deleted.	Stop the copy action.
80018	After executing the system function "OpenAllLogs", all connections between WinCC flexible and the logs have been re-established. Entries will be rewritten into the logs.	-
80019	All connections between WinCC flexible and all logs have been severed, for example, after executing the system function "CloseAllLogs". Entries will be written to the buffer and written into the logs when a connection is re-established. There is no connection to the storage location and the data medium may be in the process of being exchanged.	-
80020	The maximum number of simultaneously activated copy actions has been exceeded. Copying is not executed.	Wait until the current copying actions have been completed and restart the last copy action.

Number	Effect/cause	Remedy
80021	An attempt was made to delete a log which is still involved with a copy action. Deletion has not been executed.	Wait until the current copying actions have been completed and restart the last action
80022	Using the system function "StartSequenceLog", an attempt was made to start a sequential log for a log not configured as such. No sequential log is created.	Check the project for the following: <ul style="list-style-type: none"> • The system function "StartSequenceLog" is configured correctly. • The tag parameters are being correctly provided on the HMI device.
80023	An attempt was made to copy a log to itself. The log is not copied.	Check the project for the following: <ul style="list-style-type: none"> • The system function "CopyLog" is configured correctly. • The tag parameters are being correctly provided on the HMI device.
80024	The system function "CopyLog" is configured not to permit copying when the target log already contains data (Parameter: "Mode"). The log is not copied.	If necessary, modify the system function "CopyLog" in the project. Before initiating the system function, delete the target log.
80025	You have interrupted the copy process. Data written up to this point is retained. Deletion of the target log (if configured) is not executed. The cancellation is documented by a \$RT_ERR\$ error entry at the end of the target log.	-
80026	This notification is issued after all the logs have been successfully initialized. Values are written to the logs from this moment on. Prior to this, no entries are written to the logs even though WinCC flexible Runtime is running.	-
80027	The internal Flash memory has been specified as the storage location for a log. This is not permissible. No values will be logged for this log and the log will not be created.	Configure "Storage Card" or a network path as the storage location.
80028	The alarm serves as a status acknowledgment that initialization of the logs is currently running. No values are logged until system alarm 80026 is issued.	-
80029	The number of logs specified in the event could not be initialized. Initialization of the logs has been completed. The faulty logs are not available for logging jobs.	Evaluate the additional system alarms generated for this alarm. Check the configuration, the ODBC (Open Database Connectivity) and the specified drive.
80030	The structure of existing log does not match the expected log structure. The logging process is stopped for this log.	Delete the existing log data manually in advance.
80031	The log in CSV format is corrupted. The log cannot be used.	Delete the corrupt file.
80032	Logs can be configured with events. These are triggered as soon as the log is full. If WinCC flexible Runtime is started and the log is already full, the event will not be triggered. The log specified no longer logs data because it is full.	Stop the WinCC flexible Runtime, delete the log and restart the WinCC flexible Runtime. or: Configure a button which contains the same actions as the event and press it.

Number	Effect/cause	Remedy
80033	"System Defined" is selected in the data log as the data source name. This results in an error. No logging is made to the database log whereas the logging to the CSV logs works.	Install MSDE again.
80034	An error has occurred in the initialization of the logs. An attempt has been made to create tables as a backup. This did not work. A backup has been made of the tables of the corrupt log and the log has been newly started (empty).	No action is necessary. However, it is recommended to save the backups or delete them to free up memory.
80035	An error has occurred in the initialization of the logs. An attempt has been made to create backups of the tables and this has failed. No logging or backup has been performed.	It is recommended to save the backups or delete them to free up memory.
110000	The operating mode has been changed. The operating mode is now 'offline'.	-
110001	The operating mode has been changed. The operating mode is now "online".	-
110002	The operating mode cannot be changed.	Check the connection to the PLCs. Check whether the address area for the area pointer 88 "Coordination" in the PLC is available.
110003	The operating mode of the specified controller has been changed by the system function "SetConnectionMode". The operating mode is now "offline".	-
110004	The operating mode of the specified controller has been changed by the system function "SetConnectionMode". The operating mode is now "online".	-
110005	An attempt was made to use the system function "SetConnectionMode" to switch the specified PLC to the "online" operating mode although the entire system is in the "offline" mode. This switchover is not permissible. The PLC remains in operating mode "offline".	Switch the complete system to operating mode "online" and execute the system function again.
110006	The content of the area pointer "User version" does not match the user version configured WinCC flexible. WinCC flexible Runtime is therefore closed.	Check: <ul style="list-style-type: none"> The user version entered on the controller The user version entered in WinCC flexible
120000	The trend is not displayed because an incorrect axis to the trend or incorrect trend has been configured.	Change the configuration.
120001	The trend is not displayed because an incorrect axis to the trend or incorrect trend has been configured.	Change the configuration.
120002	The trend is not displayed because the tag assigned tries to access an invalid PLC address.	Check if the data area for the tag exists in the PLC, the configured address is correct and the value range for the tag is correct.
130000	The action was not executed.	Close the other programs. Delete files no longer required from the hard disk.
130001	The action was not executed.	Delete files no longer required from the hard disk.

Number	Effect/cause	Remedy
130002	The action was not executed.	Close the other programs. Delete files no longer required from the hard disk.
130003	No data medium is inserted. The process is stopped.	For example, check if <ul style="list-style-type: none"> • The correct data medium is being accessed • The data medium is inserted
130004	The data medium is write-protected. The process is stopped.	Check whether access has been made to the correct storage medium. Remove any write protection.
130005	The file is write-protected. The process is stopped.	Check whether access has been made to the correct file. Modify the file attributes, if necessary.
130006	No access to file is possible. The process is stopped.	For example, check if <ul style="list-style-type: none"> • The correct file is being accessed • The file exists • Another action is preventing simultaneous access to the file
130007	The network connection is interrupted. Data records cannot be saved or read over the network connection.	Check the network connection and correct the reason for the disruption.
130008	The storage card is not available. Data records cannot be saved or read to the storage card.	Insert the storage card.
130009	The specified directory is not on the storage card. The files that are saved in this directory are not saved when the HMI device is switched off.	Insert the storage card.
130010	The maximum nesting depth can be exhausted, for example, when a value change in a script results in the initiation of another script. The second script in turn has a value change resulting in the initiation of another script and so on. The configured functionality is not provided.	Check the configuration.
140000	Online connection to the PLC has been successfully established.	-
140001	Online connection to the PLC has been disconnected.	-
140003	No tag updating or writing is executed.	Check the connection and whether the PLC is switched on. Check the parameter definitions in the Control Panel using "Set PU/PC interface". Restart the system.
140004	No tag updating or writing is executed because the access point or the subrack configuration is incorrect.	Verify the connection and check whether the PLC is switched on. Check the access point or the subrack configuration (MPI, PPI, PROFIBUS) in the Control Panel with "Set PU/PC interface". Restart the system.
140005	No tag updating or writing is executed because the address of the HMI device is incorrect (possibly too high).	Use a different HMI device address. Verify the connection and check whether the PLC is switched on. Check the parameter definitions in the Control Panel using "Set PU/PC interface". Restart the system.

Number	Effect/cause	Remedy
140006	No tag updating or writing is executed because the baud rate is incorrect.	Select a different baud rate in WinCC flexible (according to module, profile, communication peer, etc.).
140007	Tags are not updated or written because the bus profile is incorrect (see %1). The following parameters cannot be entered in the registry: 1: Tslot 2: Tqui 3: Tset 4: MinTsdr 5: MaxTsdr 6: Trdy 7: Tid1 8: Tid2 9: Gap Factor 10: Retry Limit	Check the user-defined bus profile. Check the connection and whether the PLC is switched on. Check the parameter definitions in the Control Panel using "Set PU/PC interface". Restart the system.
140008	No tag updating or writing is executed because baud rate is incorrect. The following parameters cannot be entered in the registry: 0: General error 1: Incorrect version 2: Profile cannot be entered in the registry. 3: Subnet type cannot be entered in the registry. 4: Target rotation time cannot be entered in the registry. 5: Highest address (HAS) incorrect.	Check the connection and whether the PLC is switched on. Check the parameter definitions in the Control Panel using "Set PU/PC interface". Restart the system.
140009	No tag updating or writing is executed because the module for the S7 communication was not found.	Reinstall the module in the Control Panel using "Set PU/PC interface".
140010	No S7 communication peer could be found because the PLC is switched off. DP/T: The option "Is not active as the only master" is set in the Control Panel under "Set PU/PC interface".	Switch the PLC on. DP/T: If only one master is connected to the network, deactivate the option "Is not active as the only master" in "Set PU/PC interface". If there is more than one master connected to the network, activate them. Do not change any settings otherwise the bus will be disrupted.
140011	No tag updating or writing is executed because the communication is interrupted.	Check the connection and that the communication peer is switched on.
140012	There is an initialization problem (e.g. when WinCC flexible Runtime has been closed in the Task Manager). or: another application (e.g. STEP7) is active with different bus parameters and the driver cannot be started with the new bus parameters (e.g. baud rate).	Restart the HMI device. or: Start WinCC flexible Runtime first and then the other applications.
140013	The MPI cable is not plugged in; there is no power supply.	Check the connections.
140014	"Configured bus address already assigned."	Modify the HMI device address in the configuration in PLC.

Number	Effect/cause	Remedy
140015	Incorrect baud rate or: incorrect bus parameter (e.g.I) or: OP address > I or: incorrect interrupt vector (interrupt does not arrive at the driver)	Correct the incorrect parameters.
140016	Configured interrupt is not supported by the hardware.	Change the interrupt number.
140017	Configured interrupt in use by another driver.	Change the interrupt number.
140018	The consistency check was deactivated by SIMOTION Scout. Only one appropriate note appears.	Activate the consistency check with SIMOTION Scout again and reload the configuration in the project.
140019	SIMOTION Scout loads a new project to the PLC. Connection to the PLC is interrupted.	Wait until the end of the reconfiguration.
140020	The version in the PLC and that in the configuration (FWX file) do not match. Connection to the PLC is interrupted.	The following remedies are available: Load the current version in the PLC using SIMOTION Scout. Regenerate the project using WinCC flexible ES, close WinCC flexible Runtime and restart with a new configuration.
150000	No additional data is read or written. Possible causes: <ul style="list-style-type: none"> • The cable is defective. • The PLC does not respond, is defective, etc. • The connection is established via the wrong interface. • The system is overloaded. 	Check that the cable is plugged in, the PLC is operational and the correct interface is used. Reboot the system if the system alarm is displayed continuously.
150001	Connection is re-established because the cause of the interruption has been eliminated.	-
160000	No additional data is read or written. Possible causes: <ul style="list-style-type: none"> • The cable is defective. • The PLC does not respond, is defective, etc. • Connection has been established via the wrong interface. • The system is overloaded. 	Check that the cable is plugged in, the PLC is operational and the correct interface is used. Reboot the system if the system alarm is displayed continuously.
160001	Connection is re-established because the cause of the interruption has been eliminated.	-
160010	There is no connection to the server because the server identification (CLS-ID) cannot be established. Values cannot be read or written.	Check the access rights.
160011	There is no connection to the server because the server identification (CLS-ID) cannot be established. Values cannot be read or written.	For example, check if <ul style="list-style-type: none"> • The server name is correct • The computer name is correct • The server is registered

Number	Effect/cause	Remedy
160012	There is no connection to the server because the server identification (CLS-ID) cannot be established. Values cannot be read or written.	For example, check if <ul style="list-style-type: none"> • The server name is correct • The computer name is correct • The server is registered Note for experienced users: Interpret the value from HRESULT.
160013	The specified server was started as InProc Server. This has not been released and may possibly lead to incorrect e-establ because the server is running in the same process area as the WinCC flexible Runtime software.	Configure the server as OutProc Server or Local Server.
160014	Only one OPC server project can be started on a PC/MP. An error message appears when an attempt is made to start a second project. The second project has no OPC server functionality and cannot be located as an OPC server from external sources.	Do not start a second project with OPC server functionality on the computer.
170000	S7 diagnostic alarms are not displayed because it is not possible to log on to the S7 diagnostics with this unit. The service program is not supported.	-
170001	The S7 diagnostics buffer cannot be displayed because communication with the PLC has been switched off.	Switch the PLC online.
170002	The S7 diagnostics buffer cannot be displayed because reading in the diagnostics buffer (SSL) was aborted due to an error.	-
170003	The display of an S7 diagnostic alarm is not possible. An internal error %2 has been reported.	-
170004	The display of an S7 diagnostic alarm is not possible. An internal error with error class %2 and error number %3 has been reported.	-
170007	It is not possible to read in the S7 diagnostics buffer (SSL) because it was aborted with an internal error class %2 and error code %3.	-
180000	A component/OCX receives configuration data with a version identification which is not supported.	Install a newer component.
180001	The system is overloaded because too many actions have been activated simultaneously. Not all the actions can be executed; some are rejected.	Several remedies are available: <ul style="list-style-type: none"> • Increase the configured cycle times or basic clock. • Generate the alarms slower (polling). • Trigger the scripts and functions at greater intervals. If the alarm appears more frequently: Restart the HMI device.
180002	The screen keyboard could not be activated. Possible cause: The file "TouchInputPC.exe" was not registered due to an incorrectly executed Setup.	Reinstall WinCC flexible runtime.
190000	It is possible that the tag will not be updated.	-
190001	The tag is updated following an error status after the cause of the last error state has been eliminated (return to normal operation).	-

Number	Effect/cause	Remedy
190002	The tag is not updated because communication to the PLC has been interrupted.	Switch on communication via the system function "SetOnline".
190004	The tag is not updated because the configured address is not available for this tag.	Check the configuration.
190005	The tag is not updated because the configured PLC type does not exist for this tag.	Check the configuration.
190006	The tag is not updated because it is not possible to map the PLC type in the data type for the tag.	Check the configuration.
190007	The tag values are not modified because the connection to the PLC has been interrupted or the tag is offline.	Switch to online mode or re-establish connection to the PLC.
190008	The threshold values configured for the tag have been violated possibly due to: <ul style="list-style-type: none"> • an entered value • a system function • a script 	Note the configured or current threshold value of the tag.
190009	An attempt has been made to assign a value to a tag which is outside the value range permitted for this data type. E.g., a value of 260 entered for a byte tag or a value of -3 for a word tag without a sign.	Note the value range for the data type of the tags.
190010	Too many values are being used to describe a tag (i.e. in a loop triggered by a script). Values are lost because the maximum of 100 actions have been stored in the buffer.	Increase the time interval between the multi-writing tasks.
190011	Possible cause 1: The value entered could not be written to the configured PLC tag because it was either above or below the value range. The input is rejected and the original value is reset. Possible cause 2: The connection to the PLC has been interrupted.	Ensure that the value entered is within the value range of the PLC tags. Check the connection to the PLC.
190012	It is not possible to convert a value from a source format to a target format. For example: A value should be assigned to a counter which is outside the valid, PLC-dependent value range. A tag of the type Integer should be assigned a value of the type String.	Check the value range or the data type of the tags.

Number	Effect/cause	Remedy
190100	The area pointer is not updated because the configured address for this area pointer is not available. Type 1 Warning alarms 2 Error alarms 3 PLC acknowledgment 4 HMI device acknowledgment 5 LED mapping 6 Trend request 7 Trend transfer 1 8 Trend transfer 2 No.: is the consecutive number displayed in WinCC flexible ES.	Check the configuration.
190101	The area pointer is not updated because it is not possible to map the PLC type in the area pointer type. Parameter type and no.: see alarm 190100	-
190102	The area pointer is updated following an error status after the cause of the last error state has been eliminated (return to normal operation). Parameter type and no.: See alarm 190100.	-
200000	Coordination is not executed because the address configured in the PLC does not exist/has not been set up.	Change the address or set up the address in the PLC.
200001	Coordination is not executed because the address configured in the PLC does not exist/has not been written.	Change the address or set up the address in the PLC in an area which can be written to.
200002	Coordination is currently not being performed because the address format of the area pointer does not match the internal storage format.	Internal error
200003	Coordination can be executed again because the last error status has been eliminated (return to normal operation).	-
200004	The coordination may not be executed.	-
200005	No additional data is read or written. Possible causes: <ul style="list-style-type: none"> • The cable is defective. • The PLC does not respond, is defective, etc. • The system is overloaded. 	Check that the cable is plugged in and the PLC is operational. Reboot the system if the system alarm is displayed continuously.
200100	Coordination is not executed because the address configured in the PLC does not exist/has not been set up.	Change the address or set up the address in the PLC.
200101	Coordination is not executed because the address configured in the PLC does not exist/has not been written.	Change the address or set up the address in the PLC in an area which can be written to.
200102	Coordination is currently not being performed because the address format of the area pointer does not match the internal storage format.	Internal error

Number	Effect/cause	Remedy
200103	Coordination can be executed again because the last error status has been eliminated (return to normal operation).	-
200104	The coordination may not be executed.	-
200105	No additional data is read or written. Possible causes: <ul style="list-style-type: none"> • The cable is defective. • The PLC does not respond, is defective, etc. • The system is overloaded. 	Check that the cable is plugged in and the PLC is operational. Reboot the system if the system alarm is displayed continuously.
210000	Jobs are not processed because the address configured in the PLC does not exist/has not been set up.	Change the address or set up the address in the PLC.
210001	Jobs are not processed because the address configured in the PLC cannot be written to/read from.	Change the address or set up the address in the PLC in an area which can be written to/read from.
210002	Commands are not executed because the address format of the area pointer does not match the internal storage format.	Internal error
210003	The job mailbox is processed again because the last error status has been eliminated (return to normal operation).	-
210004	It is possible that the job mailbox is not processed.	-
210005	A controller job with an illegal number was triggered.	Check the PLC program.
210006	An error occurred while attempting to execute the controller job. As a result, the controller job will not be executed. Note the subsequent/previous system alarm, if appropriate.	Check the parameters in the controller job. Recompile the configuration.
220001	The tag is not downloaded because the associated communication driver / HMI device does not support downloading the data type bool/bit.	Change the configuration.
220002	The tag is not downloaded because the associated communication driver / HMI device does not support the data type byte when writing.	Change the configuration.
220003	The communication driver cannot be loaded. The driver may not be installed.	Install the driver by reinstalling WinCC flexible Runtime.
220004	Communication is terminated and no update is executed because the cable is not connected or is defective, etc.	Check the connection.
220005	Communication is running.	-
220006	The connection is established to the specified PLC at the specified interface.	-

Number	Effect/cause	Remedy
220007	The connection to the specified PLC at the specified interface is disrupted.	Check if <ul style="list-style-type: none"> • The cable is plugged in • The PLC is OK • The correct interface is used • The configuration is OK (interface parameters, protocol settings, controller address). Reboot the system if the system alarm is displayed continuously.
220008	The communication driver cannot access the specified interface or open it. It is possible that another program is using this interface or an interface is being used which is not available on the target device. There is no communication to the PLC.	Close all the programs which access the interface and restart the computer. Use another interface available in the system.
230000	The value entered could not be accepted. The entered value is rejected and the previous value is restored. Either the value range has been exceeded or impermissible characters were entered.	Enter a permissible value.
230002	Since the user currently logged on does not have the proper authorization, the input is rejected and the previous value is restored.	Log on as a user with sufficient rights.
230003	Changeover to the specified screen is not executed because the screen is not available/configured. The current screen remains selected.	Configure the screen and check the selection function.
230005	The value range of the tag has been exceeded in the I/O field. The original value of the tag is retained.	Take the value range of the tag into consideration when entering value.
230100	During navigation in the web browser, a message which may be of interest to the user is issued. The web browser continues to run, but may not (fully) display the new page.	Navigate to another page.
230200	The connection to the HTTP channel was interrupted due to an error. This error is explained by another system alarm. Data is no longer exchanged.	Check the network connection. Check the configuration of the server.
230201	The connection to HTTP channel has been re-established. Data is exchanged.	-

Number	Effect/cause	Remedy
230202	<p>WININET.DLL has detected an error. This error usually occurs when it is not possible to make a connection to the server or the server rejects the attempt to make a connection because the client lacks the authorization.</p> <p>An unknown server certificate can also be the cause when the connection is encoded through SSL.</p> <p>The text of the error message provides more information.</p> <p>This text is always in the language of the Windows installation since it originates from Windows. Process values are no longer exchanged.</p>	<p>Depending on the cause:</p> <p>When a connection cannot be made or a timeout occurs:</p> <ul style="list-style-type: none"> • Check the network connection and the network. • Check the server address. • Check if the web server is actually running on the target computer. <p>In the absence of an authorization:</p> <ul style="list-style-type: none"> • Configured user name and/or password do not match those on the server. Match them. <p>When the server certificate is rejected: Certificate signed by an unknown CA ():</p> <ul style="list-style-type: none"> • Either set the configuration to ignore this point, or • Install a certificate that has been signed with a root certificate known to the client computer. <p>If the date of the certificate is invalid:</p> <ul style="list-style-type: none"> • Either set the configuration to ignore this point, or • Install a certificate with a valid date on the server. <p>If there is an invalid CN (Common Name or Computer Name):</p> <ul style="list-style-type: none"> • Either set the configuration to ignore this point, or • Install a certificate with a name that corresponds to that of the server address.
230203	<p>Although a connection can be made to the server, the HTTP server rejects the connection because</p> <ul style="list-style-type: none"> • WinCC flexible Runtime is not running on the server, or • The HTTP channel is not supported (503 Service unavailable). <p>Other errors may occur if the web server does not support the HTTP channel. The language of the error text depends on the web server. Data is not exchanged.</p>	<p>For error 503 Service unavailable: Check if: WinCC flexible Runtime is running on a server. The HTTP channel is supported.</p>
230301	<p>An internal error has occurred. An English text explains the error somewhat more specific. One possible cause is insufficient memory, for example. OCX does not work.</p>	-
230302	<p>The name of the remote server cannot be determined. No connection can be established.</p>	<p>Check the configured server address. Check if the DNS service of the network is activated.</p>
230303	<p>The remote server is not running on the addressed computer. The server address is incorrect. No connection can be established.</p>	<p>Check the configured server address. Check if the remote server is running on the target computer.</p>
230304	<p>The remote server on the addressed computer is incompatible to VNCOCX. No connection can be established.</p>	<p>Use a compatible remote server.</p>
230305	<p>The authentication has failed because the password is incorrect. No connection can be established.</p>	<p>Configure the correct password.</p>

Number	Effect/cause	Remedy
230306	The connection to the remote server has been interrupted. This may occur during network problems. No connection can be established.	Check if <ul style="list-style-type: none"> • The cable is plugged in • there are network problems.
230307	The connection to the remote server was ended because <ul style="list-style-type: none"> • The remote server was shut down, or • The user instructed the server to close all connections. The connection is closed.	-
230308	This notification informs you about the establishment of the connection. A connection has just been established.	-
240000	WinCC flexible Runtime is operating in demo mode. You have no authorization or your authorization is corrupt.	Load the authorization.
240001	WinCC flexible Runtime is operating in demo mode. Too many tags are configured for the installed version.	Load an adequate authorization / powerpack.
240002	WinCC flexible Runtime is operating with a time-limited standby authorization.	Restore the full authorization.
240003	Authorization cannot be executed. Without authorization, WinCC will run in demo mode.	Restart WinCC flexible Runtime or reinstall it.
240004	Error while reading the standby authorization. WinCC flexible Runtime is operating in demo mode.	Restart WinCC flexible Runtime, install the authorization or repair the authorization (see Commissioning Instructions Software Protection).
250000	The tag in the specified line in "Status force" is not updated because the address configured for this tag is not available.	Check the set address and then check that the address has been set up in the PLC.
250001	The tag in the specified line in "Status force" is not updated because the PLC type configured for this tag is not available.	Check the set address.
250002	The tag in the specified line in "Status force" is not updated because it is not possible to map the PLC type in the tag type.	Check the set address.
250003	No connection could be established to the PLC. The tags will not be updated.	Check the connection to the PLC. Check that the PLC is switched on and online.
260000	An unknown user or an unknown password has been entered in the system. The current user is logged off the system.	Log on to the system as a user with a valid password.
260001	The logged on user does not have sufficient authorization to perform the protected functions on the system.	Log on to the system as a user with sufficient authorization.
260002	This notification is triggered by the system function "TrackUserChange".	-
260003	The user has logged off the system.	-
260004	The user name entered into the user display already exists in the user administration.	Select another user name because user names have to be unique in the user administration.
260005	The entry is rejected.	Use a shorter user name.

Number	Effect/cause	Remedy
260006	The entry is rejected.	Use a shorter or longer password.
260007	The logoff time you entered is outside the valid range of 0 to 60 minutes. The entered value will be discarded and the original value retained.	Enter a value between 0 and 60 minutes for the logoff time.
260008	An attempt was made to read a PTProRun.pwl file created with ProTool V 6.0 in UTAH. Reading the file was interrupted due to format incompatibility.	-
270000	A tag is not displayed in the alarm because it attempts to access an invalid address in the PLC.	Check if the data area for the tag in the controller exists, whether the configured address is correct and whether the value range for the tag is correct.
270001	There is a unit-dependent limit as to how many alarms may be queued simultaneously in order to be displayed (see Commissioning Instructions). This limit has been exceeded. The display no longer contains all the alarms. However, all the alarms are recorded in the alarm buffer.	-
270002	Alarms are displayed from a log for which there is no data in the current project. Placeholders are issued for the alarms.	Delete older log data, if necessary.
270003	The service cannot be set up because too many devices want to set up this service. A maximum of four devices may execute this action.	Connect fewer HMI devices which want to use the service.
280000	Connection is reestablished because the cause of the interruption has been eliminated.	-
280001	No additional data is read or written. Possible causes: <ul style="list-style-type: none"> • The cable is defective. • The PLC does not respond, is defective, etc. • Connection has been established via the wrong interface. • The system is overloaded. 	Check if <ul style="list-style-type: none"> • The cable is plugged in • The PLC is OK • The correct interface is used. Reboot the system if the system alarm is displayed continuously.
280002	A connection is used which requires a function module in the PLC. The function block has replied. Communication can now proceed.	-

Number	Effect/cause	Remedy
280003	A connection is used which requires a function module in the PLC. The function block has not replied.	Check if: <ul style="list-style-type: none"> • The cable is plugged in • The PLC is OK • The correct interface is used. Reboot the system if the system alarm is displayed continuously. The remedy depends on the error code: <ol style="list-style-type: none"> 1: The function block must set the COM bit in the response container. 2: The function block must not set the ERROR bit in the response container. 3: The function block must respond within the specified time (timeout). 4: Establish an online connection to the controller.
280004	Connection to the PLC is interrupted. There is no data exchange at present.	Check the connection parameters in WinCC flexible. Check that the cable is plugged in, the PLC is operational and the correct interface is used. Reboot the system if the system alarm is displayed continuously.
290000	The recipe tag could not be read or written to. It is assigned the start value. The alarm can be entered in the alarm buffer for up to four more failed tags, if necessary. After that, the alarm number 290003 is issued.	Check in the configuration that the address has been set up in the PLC.
290001	An attempt has been made to assign a value to a recipe tag which is outside the value range permitted for this type. The alarm can be entered in the alarm buffer for up to four more failed tags, if necessary. After that, the alarm number 290004 is issued.	Note the value range for the tag type.
290002	It is not possible to convert a value from a source format to a target format. The alarm can be entered in the alarm buffer for up to four more failed recipe tags, if necessary. After that, the alarm number 290005 is issued.	Check the value range or type of the tag.
290003	This alarm is issued when alarm number 290000 is triggered more than five times. In this case, no further individual alarms are generated.	Check in the configuration that the tag addresses have been set up in the PLC.
290004	This alarm is issued when alarm number 290001 is triggered more than five times. In this case, no further individual alarms are generated.	Note the value range for the tag type.
290005	This alarm is issued when alarm number 290002 is triggered more than five times. In this case, no further individual alarms are generated.	Check the value range or type of the tag.
290006	The threshold values configured for the tag have been violated by values entered.	Note the configured or current threshold value of the tag.

Number	Effect/cause	Remedy
290007	There is a difference between the source and target structure of the recipe currently being processed. The target structure contains an additional data recipe tag which is not available in the source structure. The data recipe tag specified is assigned its start value.	Insert the specified data recipe tag in the source structure.
290008	There is a difference between the source and target structure of the recipe currently being processed. The source structure contains an additional data recipe tag which is not available in the target structure and therefore cannot be assigned. The value is rejected.	Remove the specified data recipe tag in the specified recipe from the project.
290010	The storage location configured for the recipe is not permitted. Possible causes: Impermissible characters, write protected, data medium full or does not exist.	Check the configured storage location.
290011	The data record with the specified number does not exist.	Check the source for the number (constant or tag value).
290012	The recipe with the specified number does not exist.	Check the source for the number (constant or tag value).
290013	An attempt was made to save a data record under a data record number which already exists. The action is not executed.	The following remedies are available: <ul style="list-style-type: none"> • Check the source for the number (constant or tag value). • First, delete the data record. • Change the "Overwrite" function parameter.
290014	The file specified to be imported could not be found.	Check the following: <ul style="list-style-type: none"> • Check the file name. • Ensure that the file is in the specified directory.
290020	Acknowledgment that downloading of data records from HMI device to controller has started.	-
290021	Acknowledgment that downloading of data records from HMI device to controller was completed without errors.	-
290022	Acknowledgment that downloading of data records from HMI device to controller was aborted due to an error.	Check the configuration: <ul style="list-style-type: none"> • Are the tag addresses configured in the PLC? • Does the recipe number exist? • Does the data record number exist? • The "Overwrite" function parameter set?
290023	Acknowledgment that downloading of data records from the controller to the HMI device has started.	-
290024	Acknowledgment that downloading data records from the controller to the HMI device was completed without errors.	-
290025	Acknowledgment that downloading of data records from the controller to the HMI device was aborted due to an error.	Check the configuration: <ul style="list-style-type: none"> • Are the tag addresses configured in the PLC? • Does the recipe number exist? • Does the data record number exist? • The "Overwrite" function parameter set?

Number	Effect/cause	Remedy
290026	An attempt has been made to read/write a data record although the data mailbox is not free at present. This error may occur in the case of recipes for which downloading with synchronization has been configured.	Set the data mailbox status to zero.
290027	No connection to the PLC can be established at present. As a result, the data record can neither be read nor written to. Possible causes: No physical connection to the controller (no cable plugged in, cable is defect) or the controller is switched off.	Check the connection to the PLC.
290030	This alarm is issued after reselecting a screen that contains a recipe display in which a data record is already selected.	Reload the data record from the storage location or retain the current values.
290031	While saving, it was detected that a data record with the specified number already exists.	Overwrite the data record or cancel the action.
290032	While exporting data records, it was detected that a file with the specified name already exists.	Overwrite the file or cancel the process.
290033	Confirmation request before deleting data records.	-
290040	A data mailbox error with error code %1 that cannot be described in more detail occurred. The action is cancelled. It is possible that the data mailbox was not installed correctly on the controller.	Check the storage location, the data record, the "Data record" area pointer and, if necessary, the connection to the controller. Wait a short period of time and then trigger the action again. If the error persists, contact Customer Support. Provide them with the error code.
290041	A data record or file cannot be saved because the storage location is full.	Delete files no longer required.
290042	An attempt was made to execute several recipe actions simultaneously. The last action was not executed.	Wait a short period of time and then trigger the action again.
290043	Confirmation request before storing data records.	-
290044	The data store for the recipe has been destroyed and will be deleted.	-
290050	Acknowledgment that the export of data records has started.	-
290051	Acknowledgment that the export of data records was completed successfully.	-
290052	Acknowledgment that the export of data records was aborted due to errors.	Ensure that the structure of the data records at the storage location and the current recipe structure on the HMI device are identical.
290053	Acknowledgment that the import of data records has started.	-
290054	Acknowledgment that the import of data records was completed successfully.	-
290055	Acknowledgment that the import of data records was aborted due to errors.	Ensure that the structure of the data records at the storage location and the current recipe structure on the HMI device are identical.

Number	Effect/cause	Remedy
290056	The value in the specified line/column could not be read/written without errors. The action was cancelled.	Check the specified line/column.
290057	The tags of the specified recipe were switched from operating mode "offline" to "online". Each modification of a tag in this recipe is now immediately transferred to the PLC.	-
290058	The tags of the specified recipe were switched from operating mode "online" to "offline". Modifications to tags in this recipe are no longer immediately transferred to the PLC but must be transferred there specifically if necessary by downloading a data record.	-
290059	Acknowledgment that the specified data record was stored successfully.	-
290060	Acknowledgment that the data record memory was cleared successfully.	-
290061	Acknowledgment that clearing the data record memory was aborted due to errors.	-
290062	The data record number is above the maximum of 65536. This data record cannot be created.	Select another number.
290063	This occurs with the system function "ExportDataRecords" when the parameter "Overwrite" is set to "No". An attempt has been made to save a recipe with a file name that already exists. The export is cancelled.	Check the system function "ExportDataRecords".
290068	Request to confirm whether all data records in the recipe should be deleted.	-
290069	Request to confirm whether all data records of all recipes should really be deleted.	-
290070	The data record specified is not in the import file.	Check the source of the data record number or data record name (constant or tag value).
290071	During the editing of data record values, a value was entered that was below the lower limit of the recipe tag. The entry is rejected.	Enter a value within the limits of the recipe tag.
290072	During the editing of data record values, a value was entered that was above the upper limit of the recipe tag. The entry is rejected.	Enter a value within the limits of the recipe tag.
290073	An action (e.g. saving a data record) was not possible due to an unknown reason. The error corresponds to the status alarm IDS_OUT_CMD_EXE_ERR in the large recipe view.	-
290074	While saving, it was detected that a data record with the specified number already exists but under another name.	Overwrite the data record, change the data record number, or cancel the action.

Number	Effect/cause	Remedy
290075	A data record with this name already exists. Saving the data record is stopped.	Select a different data record name.
300000	Process monitoring (e.g. using Pdiag or S7-Graph) has been incorrectly programmed. More alarms are queued than specified in the technical data of the CPU. No further ALARM_S alarms can be managed by the PLC and reported to HMI devices.	Change the PLC configuration.
300001	Logon cannot be performed for ALARM_S on this PLC.	Select a PLC that supports the ALARM_S service.
310000	An attempt is being made to print too many reports simultaneously. Since only one report can be printed at a time, the print job is rejected.	Wait until the printout of the previous active report has finished. Repeat the print job if necessary.
310001	An error occurred on triggering the printer. The report is either not printed or printed with errors.	Evaluate the additional system alarms generated for this alarm. Repeat the print job if necessary.
320000	The movements have already been indicated by another device. The movements can no longer be controlled.	Select the movements on the other display units and select the movement screen on the required display unit.
320001	The network is too complex. The defective operands cannot be displayed.	Display the network in STL.
320002	No diagnostics-capable error alarms have been selected. The units related to the error alarm could not be selected.	Select a diagnostics-capable error alarm in the screen ZP_ALARM.
320003	No error alarms exist in respect to the selected unit. No network can be displayed in the detail display.	Select the defective unit in the overview screen.
320004	The required signal statuses could not be read by the PLC. The defective operands cannot be determined.	Check the consistency between the configuration on the display unit and the PLC program loaded.
320005	The project contains ProAgent partitions which are not installed. No ProAgent diagnostics can be performed.	In order to run the project, install the ProAgent option packet.
320006	You have attempted to execute a function that is not possible with the current configuration.	Check the type of the selected unit.
320007	No operands causing a fault have been found in the networks. ProAgent cannot display any blocked operands.	Switch the Detail Screen to STL display mode and check the status of the operands and exclusion operands.
320008	The diagnostic data saved in the configuration is not synchronized with that in the PLC. ProAgent can only display the diagnostic units.	Recompile the project and download it to the HMI device again.
320009	The diagnostic data saved in the configuration is not fully synchronized with that in the PLC. The diagnostic screens can be operated normally. ProAgent may be unable to display all diagnostic texts.	Recompile the project and download it to the HMI device again.
320010	The diagnostic texts saved in the configuration are not synchronized with that in the STEP7. The ProAgent diagnostics data is not up-to-date.	Recompile the project and download it to the HMI device again.

Number	Effect/cause	Remedy
320011	There is no unit with the referenced DB number and FB number. The function cannot be executed.	Check the parameters of function "SelectUnit" and the units selected in the project.
320012	The "Step sequence mode" dialog box is no longer supported.	Use Step Sequence Screen ZP_STEP from the appropriate standard project for your project. Instead of calling function Overview_Step_Sequence_Mode, call the function "FixedScreenSelection" using ZP_STEP as the screen name.
320014	The selected PLC cannot be evaluated for ProAgent. The alarm view configured with the system function "EvaluateAlarmDisplayFault" could not be found.	Check the parameters of the system function "EvaluateAlarmDisplayFault".

Abbreviations

B.1 Abbreviations

CPU	Central Processing Unit
CSV	Comma Separated Values
CTS	Clear To Send
DC	Direct Current
DCD	Data Carrier Detect
DP	Decentralized Periphery
DSN	Data Source Name
DSR	Data Set Ready
DTR	Data Terminal Ready
ESD	Electrostatically Sensitive Devices
EMC	Electromagnetic Compatibility
EN	European Norm
ES	Engineering System
ESD	Electrostatic Sensitive Device
GND	Ground
HF	High Frequency
HMI	Human Machine Interface
IEC	International Electronic Commission
IF	Interface
LED	Light Emitting Diode
MMC	Multi Media Card
MOS	Metal Oxide Semiconductor
MPI	Multipoint Interface (SIMATIC S7)
MTBF	Mean Time Between Failures
N.C.	Not connected
OP	Operator Panel
PC	Personal Computer
PU	Programming Unit
PPI	Point to Point Interface (SIMATIC S7)
RAM	Random Access Memory
RTS	Request To Send
RxD	Receive Data
SELV	Safety Extra Low Voltage

Abbreviations

B.1 Abbreviations

SP	Service Pack
PLC	Programmable Logic Controller
STN	Super Twisted Nematic
Sub-D	Subminiature D (plug connector)
TCP/IP	Transmission Control Protocol/Internet Protocol
TFT	Thin Film Transistor
TxD	Transmit Data
UL	Underwriter's Laboratory

Glossary

Acknowledge

Acknowledgement of an alarm confirms that it has been noted.

AG

A PLC in the SIMATIC S5 series, e.g. the AG S5-115U

Alarm, acknowledging

Acknowledgement of an alarm confirms that it has been noted.

Alarm, arriving

Moment at which an alarm is triggered by the PLC or HMI device.

Alarm, departing

Moment at which the triggering of an alarm by the PLC is reset.

Alarm logging

The printout of user-defined alarms parallel to output on the HMI device screen.

Alarm, user-defined

A user defined alarm can be assigned to one of the following alarm classes:

- Fault
- Operation
- User-defined alarm classes

A user-defined alarm makes reference to a certain operating status of the monitored system which is connected to the HMI device via the PLC.

AS

A PLC in the SIMATIC S7 series, e.g. the SIMATIC S7-300

AS 511

The protocol of the programming unit interface to the PLC SIMATIC S5

Booting

Also refer to Starting.

Booting

An option for updating the operating system. When a functional operating system is available, updating can be carried out without booting. Otherwise, updating with booting is necessary. In this case, the configuration computer communicates with the HMI device via the boot loader.

Configuration computer

The general term for programming units and PCs on which projects are created, using a configuration software, for use monitoring a system.

Configuration software

A software to create projects which serves for process visualization. Also refer to project, process visualization and runtime software.

Conventions

A system of characters, symbols and rules governing language syntax; in data processing they define the syntax of the programming language.

Display duration

Defines whether and how long a system alarm is displayed on the HMI device.

Event

Functions are triggered by the arrival of defined events. Events can be configured. Events which can be configured for a button include "press button" and "release button".

Fault time

This relates to the time interval between the arrival and departure of an alarm.

Field

An area reserved in configured screens for entering input and output values.

Flash memory

A memory with non-volatile memory chips which is used as a mobile storage medium in the form of a memory card or installed permanently on the main board. The mobile storage medium market is determined by Flash memories; CompactFlash and SmartMedia are predominant.

CompactFlash (CF) and SmartMedia (SM) differ in their basic, inner design. In the case of CF cards, the control electronics are in the card whereby, with SM cards, the control electronics are installed in the associated device.

Function

A function is linked to an icon in the Control Panel or an operating element in the project.

Half brightness life

Time period after which the brightness of the lighting tube only achieves 50% of its original value. The specified value depends on the operating temperature.

Hardcopy

Represents a printout of the current screen content on a connected printer.

Help text

Configurable information on objects in a project. The operator note concerning an alarm can, for example, contain information on the cause of the fault and methods of elimination.

Image

A file which can be transferred from the configuration computer to the HMI device. The image contains the operating system for the HMI device and parts of WinCC flexible runtime required to run a project.

I/O field

The I/O field enables values to be entered or output on the HMI device which are then transferred to the PLC.

Job mailbox

This triggers a function via the PLC.

Object

A component part of a project, e.g. a screen or alarm. Objects serve to display or enter texts and values on the HMI device.

Operating element

A component part of a project used to enter values and trigger functions. A button, for example, is an operating element.

PLC

A general term for devices and systems with which the HMI device communicates, e.g. SIMATIC S7.

Process visualization

The representation of processes from the areas of production, logistics and services using texts and graphics. Configured elements enable the data to be read from and written to processes running on systems being monitored and, thus, to actively intervene in them.

Project

The result of a configuration using a configuration software. The project contains system-specific objects, basic settings and alarms in the form of screens. The project is saved in the project file with the file name extension *.hmi if it has been configured with WinCC flexible.

It is important to differentiate between the project on the configuration computer and that on the HMI device. A project on the configuration computer can be available in several languages than can be managed on the HMI device. The project on the configuration computer can be set up for different HMI devices. Only the project set up for a particular HMI device can be transferred to that HMI device.

Project file, compressed

The file which is generated and transferred to the HMI device when "Enable BackTransfer" is enabled during configuration on the configuration computer.

Recipe

A combination of tags to a fixed data structure. The data structure configured can be assigned data on the HMI device and is then referred to as a data record. The use of recipes ensures that when a data record is downloaded, all the assigned data is transferred to the PLC at the same time.

Remote on/off

An option in the "Loader" menu which enables and disables remote control of the HMI device from the PLC.

Runtime software

Software for process visualization with which a project on a configuration computer can be tested. Also refer to project and configuration software.

Screen

A screen displays all the logically related process data on the HMI device. The display of the process data can be supported by graphic objects.

Screen object

A configured object for displaying or operating the system being monitored, e.g. a rectangle, an I/O field or recipe view.

Softkey

A key on the HMI device which can be configured as required. A function is assigned to the key during the configuration. The assignment of the softkeys may be dependent on the screen being displayed or independent of the screen displayed.

Start

A project can be started by means of a button in the loader. This process is referred to as starting or booting.

STEP 7

Programming software for SIMATIC S7, SIMATIC C7 and SIMATIC WinAC.

Symbolic I/O field

A field for the input/output of a parameter. It contains a list of predefined entries from which one can be selected.

System alarms

Assigned to the "System" alarm class. A system alarm makes reference to internal states in the HMI device and the PLC.

System, monitored

A general term for machines, processing centers, systems and plants as well as processes which are to be operated and observed by an HMI device.

Tab order

Defined during the configuration to set the It sets the sequence in which objects are focused on when the <TAB> key is pressed.

Tag

A defined memory location in which values can be written to and read from. This can be done from the PLC or via the HMI device. Depending on whether the tags have a connection to the PLC or not determines the difference between "external" tags (process tags) and "internal" tags.

Transfer

The transfer of a run-capable project to the HMI device.

Transfer mode

An HMI device operating mode. Setting the HMI device to transfer mode is a condition for transferring data from the configuration computer to the HMI device.

Index

A

ACK

- Key, 9-12

Acknowledge

- Key, 9-12

acknowledgement

- Acoustic, 1-5, 1-6, 6-17, 9-3, 12-7

- visual, 9-3

- with touch control, 9-3

Acknowledgement groups, 1-7

Acoustic acknowledgement, 1-5, 1-6, 6-17, 9-3, 12-7

Additional applications, 6-16

- Memory requirements, 6-16

Air discharge, 12-8

Alarm acquisition, 1-7

Alarm buffer, 1-7

- in Runtime, 8-2

Alarm events, 1-7

Alarm indicator

- Behavior, 9-26

- in Runtime, 8-3

- Purpose, 9-25

Alarm log

- in Runtime, 8-2

- Scope of alarm logging, 8-4

Alarm logging, 1-7

Alarm protocol, 8-2, 8-8

Alarm view

- in Runtime, 8-2

- Layout, 9-27

- Operating elements, 9-27

- Purpose, 9-26

Alarm window

- in Runtime, 8-3

ALARM_S, 1-7

Alarms

- Functional scope, 1-6

- in Runtime, 8-2

Alignment

- Printer, 6-12

Alphanumeric key assignment, 9-12

Alphanumeric keys, 5-7

Alphanumeric screen keyboard, 9-7, 9-9

ALT

- Key, 9-13

Alt layer

- Screen keyboard, 9-9

Ambient conditions, 12-8

Angle of inclination, 3-4, 12-8

application

- In industrial areas, 2-1

- In residential areas, 2-2

Approvals, A-1

ASCII character set

- Printer, 4-11

Attachment, 4-1

- Keyboard unit, 4-2

- Touch panel unit, 4-3

Authorization

- Back transfer, 7-20

- in Runtime, 8-7

- Transfer, 7-20

B

Back transfer, 7-10

- Execute, 7-11

- Requirements, 7-10

Back-lighting

- Screen, 1-4, 12-6

- Switch off, 6-14

Backspace

- Key, 9-12

Backup, 7-14, 12-7

Backup battery, 1-10, 4-6, 12-7

- Changing, 11-2

Bar

- Layout, 9-37

- Operation, 9-37

- Purpose, 9-36

Barometric pressure, 12-8

Battery, 1-10, 12-7

- Changing, 11-2

Battery connection, 4-6

Baud rate

- Printer, 6-12

- Transfer mode, 7-5

- Behavior
 - Alarm indicator, 9-26
 - I/O field, 9-20
 - Icon, 9-55
 - Recipe view with screen change, 9-31
 - Simple recipe view, 9-34
 - Sm@rtClient view, 9-52
- Brightness
 - Set, 6-8, 9-13
- Bulk storage, 1-12, 12-6
- Burst interference, 12-9
- Button
 - Layout, 9-17
 - Purpose, 9-17
- Button action feedback, 9-3

C

- Cable cross-section, 4-17
- Cables, 3-2
- Calibration
 - Touchscreen, 6-8
- Calling
 - Operator note: Touch panel unit, 9-9
 - Operator note: keyboard device, 9-16
 - Operator note: screen keyboard, 9-6
 - Operator note: screen keyboard, 9-9
 - Operator note: System function, 9-10
 - Operator note: touch panel, 9-6, 9-10
 - Remote control, 9-52
 - Remote monitoring, 9-52
- Cancel
 - Key, 9-12
- Capacity
 - Alarm buffer, 1-7
 - Backup battery, 12-7
 - Memory, 1-4
- Certificate
 - ESD, A-2
- CF card, 1-12, 12-6
- Changing
 - Battery, 11-2
 - Language, 7-11
 - Recipe data record in Runtime, 10-15
- Character set
 - Printer, 4-11
- Cleaning
 - Device, 11-1
- Cleaning agents, 11-1
- Clock
 - Internal, 1-10
 - Operation, 9-45
 - Purpose, 9-44, 9-45
- Close
 - Dialog, 9-15
- Color change
 - Input box, 9-15
- Color display, 1-4, 1-5, 12-6
- Colors, 1-4, 12-6
- Combo box
 - Open, 9-13
- Commissioning for the first time, 7-1
- Communication, 1-9
 - PLCs from other manufacturers, 1-10
 - SIMATIC PLCs, 1-9
- Communication options, 4-7
- Compact Flash, 1-12
- Compatibility conflict, 7-2, 7-3
- Compressing
 - PU functions, 4-14
- Conditions for use, 3-2
- Conduction
 - RF, 12-9
- Configuration, 10-6
 - Memory location, 7-6
 - Of recipes, 10-6
 - Source file, 7-7
- Configuration computer
 - Connecting, 4-15
- Configuration phase, 1-4
- Configuration software, 1-3, 1-6
- Configuring
 - Interface IF1B, 4-13
- Conflict
 - Compatibility, 7-2, 7-3
- Connecting
 - Configuration computer, 4-15
 - external keyboard, 4-11
 - Mouse, 4-11
 - PLC, 4-13
 - Power supply, 4-17
 - Printer, 4-10
 - UPS, 4-16
- Connection
 - Electrical, 4-5
 - To configuration computer, 4-15
 - To external keyboard, 4-11
 - To mouse, 4-11
 - To PLC, 4-13
 - To printer:, 4-10
- Connection sequence, 4-5
- Contact discharge, 12-8
- Contrast
 - Display, 6-8
 - Set, 9-13
- Control keys, 5-6

- Control mode
 - Remote control, 9-53
 - Sm@rtClient view, 9-53
- Conversion functions, 1-8
- Copy
 - Recipe data record in Runtime, 10-14
- create
 - Recipe record on the HMI device, 10-14
- Cross-section
 - Power supply cable, 4-17
- CSV file, 10-4
- CTRL
 - Key, 9-13
- Cursor
 - Key, 5-7, 9-12
- Cut-out
 - Installation, 12-5

D

- Data
 - Technical, 12-5
- Data log
 - in Runtime, 8-4
- Data loss, 7-16
- Data mailbox
 - For recipes, 10-7
- Data record
 - exporting, 10-17
 - importing, 10-17
 - reading, 10-16
 - Transfer, 10-17
- Date, 6-5, 7-2
- date and time
 - synchronizing, 6-5
- Date/time field
 - Behavior, 9-43
 - Keyboard control, 9-43, 9-44
 - Layout, 9-43
 - Mouse control, 9-44
 - Purpose, 9-43
 - Touch control, 9-43
- Default setting
 - Printer, 6-12
- Degree of protection, 1-2, 3-3, 12-6
- Delete
 - Key, 9-12
- deleting
 - Recipe data record in Runtime, 10-15
- Depth
 - Installation, 12-6
- Device data
 - Displaying, 6-10

- Dialog
 - Closing, 9-15
- Dim back-lighting
 - Screen, 6-13
- Dimensions, 12-5
 - MP 270B 10" Keys, 12-3
 - MP 270B 10" Touch, 12-1
 - MP 270B 6" Touch, 12-2
 - OP 270 10 inch, 12-3
 - OP 270 6 inch, 12-4
 - TP 270 10", 12-1
 - TP 270 6", 12-2
- Direct key, 9-3
- Directives
 - EEC, 12-8
- Discharge
 - Static, 12-8
- Display, 1-4, 1-5
 - Set brightness, 6-7
- DNS server, 6-18

E

- Editing, 10-4
 - Recipe data record in WinCC flexible, 10-4
 - Recipe record, 10-4
- Electrostatic discharge
 - Precautions, A-2
- EMC Guidelines, 3-1
- END
 - Key, 9-12
- Enter
 - Key, 9-12
- ENTER
 - Key, 9-12
- ESC
 - Key, 9-12
- ESC/P compatibility, 4-10
- ESD, A-2
 - Handling, A-2
 - Measuring, A-3
 - Shipping, A-3
- Ethernet, 6-18
- Ethernet interface, 4-6
 - Assignment, 12-11
- Example
 - Network functions, 6-22
- Exchange
 - Labeling strips, 5-8
- exporting
 - Recipe, 10-17
 - Recipe record, 10-17
 - User data, 8-8

Extend

Memory, 1-13

External dimensions, 12-5

External keyboard

Connecting, 4-11

Operation, 5-12

F

Features, 1-1, 1-4, 1-5

Field of Application, 1-2

Flashing

LED, 5-5

FM approval, A-1

Foil

Labeling strips, 5-9

Forcing

Permissions in remote operation, 9-54

Format

Paper, 6-12

Front panel

Thickness, 3-3, 3-5, 3-6

Function keys, 1-4, 1-6

Local assignment, 1-4, 1-6

Functional scope, 1-6

G

Gauge

Layout, 9-42

Operation, 9-42

Purpose, 9-42

General operation

Keyboard unit, 9-11

Touch panel unit, 9-2

Global softkey, 5-5

Graphic I/O field

Purpose, 9-21

Ground connection, 4-6, 4-8

Grounding, 4-8

Grounding screw, 4-8

Group acknowledgement, 1-7, 9-12

Guidelines

ESD, A-2

H

Hardware options, 1-10

Hazardous location, A-1

Help text, 1-8

Calling:keyboard device, 9-16

calling:screen keyboard, 9-6, 9-9

Calling:system function, 9-10

Calling:Touch panel, 9-6, 9-9, 9-10

viewing (key), 9-12

Hide

Screen keyboard, 9-6, 9-9

High frequency radiation, 2-1

HMI device

Name in the network, 6-5

Recommissioning, 7-3

remote control, 9-52

remote monitoring, 9-52

Transfer mode, 7-3

HOME

Key, 9-12

Housing, 12-5

I

I/O field

Behavior, 9-20

Keyboard control, 9-20, 9-21

Layout, 9-20

Mouse control, 9-21

Purpose, 9-19

Touch control, 9-20

Icon, 5-5

Behavior, 9-55

Purpose, 9-55

Immunity to interference

EMC Guidelines, 3-1

importing

Recipe, 10-17

Recipe record, 10-17

User data, 8-8

Increase

Brightness, 6-8

Contrast, 6-8

information

General, 2-1

- Input
 - Alphanumeric values, 9-7
 - Alphanumeric values:touch panel, 9-9
 - Numeric values, 9-5
 - Numeric values:touch panel, 9-6
 - Values, 9-15
- Input of alphanumeric values, 9-7
 - Touch panel unit, 9-9
- Input of numeric values, 9-5
 - Touch panel unit, 9-6
- Input of values, 9-15
- Installation
 - Configuration computer, 4-15
 - external keyboard, 4-11
 - in 19 inch cabinets, 4-1
 - Mechanical, 4-1, 4-3
 - Mouse, 4-11
 - MP 270B 10" Keys, 4-1
 - MP 270B 6" Touch, 4-3
 - OP 270 10 inch, 4-1
 - OP 270 6 inch, 4-1
 - PLC, 4-13
 - Printer, 4-10
 - Spring terminal, 4-2, 4-3
 - TP 270 10", 4-3
 - TP 270 6", 4-3
- Installation conditions, 3-3
- Installation cut-out, 12-5
 - MP 270B 10" Keys, 3-5
 - MP 270B 10" Touch, 3-5
 - MP 270B 6" Touch, 3-5
 - OP 270 10 inch, 3-5
 - OP 270 6 inch, 3-6
 - TP 270 10", 3-5
 - TP 270 6", 3-5
- Installation depth, 12-6
- Installation dimensions
 - 19 inch cabinets, 4-1
- Installation location, 1-2, 3-3
- Installation position, 12-8
- Interface assignments, 12-9
- Interface IF1A
 - Assignment, 12-9
- Interface IF1B
 - Assignment, 12-10
- Interface IF2
 - Assignment, 12-10
- Interfaces, 1-4, 1-5
 - Configure 1F1B, 4-13
 - IF1A, 4-13
 - IF1B, 4-13
 - IF2, 4-15
- Internet Explorer, 1-14
- Irradiation
 - RF, 12-8
- K**
 - Key pads, 5-3, 5-4
 - Keyboard, 1-4, 1-6, 12-7
 - Connecting, 4-11
 - Keyboard control
 - Date/time field, 9-43, 9-44
 - I/O field, 9-20, 9-21
 - Keyboard layers, 9-8, 9-9
 - Keys
 - Remote control, 9-54
- L**
 - Labeling
 - Softkey, 5-7
 - Labeling strips, 4-1
 - Exchange, 5-8
 - MP 270B 10" Keys, 5-9
 - OP 270 10 inch, 5-9
 - OP 270 6 inch, 5-9
 - Printing, 5-11
 - Template file, 5-11
 - Landscape format
 - Printer, 6-12
 - Language
 - Set, 7-11
 - Language switching, 7-11, 9-1
 - Layout
 - Alarm view, 9-27
 - Bar, 9-37
 - Button, 9-17
 - Gauge, 9-42
 - I/O field, 9-20
 - Recipe view, 9-31
 - Simple alarm view, 9-29
 - Simple recipe view, 9-34
 - Simple user view, 9-47
 - Slider control, 9-40
 - Sm@rtClient view, 9-52
 - Status/Force, 9-50
 - Switch, 9-18
 - Trend view, 9-38
 - User view, 9-45
 - LED control, 5-5, 8-9
 - Light emitting diode
 - Acknowledge, 9-12
 - Help text, 9-12
 - Softkey, 5-5
 - Toggle, 9-12

- Limit value monitoring, 1-8
- Lines, 3-2
- Literature, 1-6
- Lithium battery, 11-3, 12-7
 - Warning, 11-3
- Load
 - Project data, 7-1
 - Recipe data record in Runtime, 10-15
- Loader, 6-1
 - Password protection, 6-2
- Local function keys, 5-5
- Log
 - in Runtime, 8-3
 - Memory options, 8-3
- Logging, 1-8
 - Scope of alarm logging, 8-4
- Logoff time
 - exporting/importing, 8-8
 - in Runtime, 8-8
- Logs, 1-8

M

- Maintenance, 11-1
- Manual transfer, 7-3
- Mechanical installation, 4-1, 4-3
- Membrane keyboard, 1-4, 1-6, 12-7
- Memory, 1-4, 1-5
- Memory card, 1-12
- Memory extension, 1-5, 1-6
- Memory location
 - Project file, 7-6
- Menu bar
 - Enable, 9-14
- Modal dialogs, 7-4
- Mode
 - Printer, 6-12
- Modifying recipe structures, 10-19
- Monitoring mode
 - Sm@rtClient view, 9-53
- Mouse
 - Connecting, 4-11
 - Operation, 5-12
- Mouse control
 - Date/time field, 9-44
 - I/O field, 9-21
- Mouse pointer, 5-12
- MPI address
 - Transfer mode, 7-5
- MPI transfer, 7-6
- Multifunctional platform, 1-1
- Multiple key operation, 9-1

N

- Navigating
 - Operating system, 9-14
- Network connection, 12-7
- Noise immunity, 12-8
- Norms, 12-8
- Notes
 - Safety, 2-1
- Number
 - Alarms, 1-6
 - Data records, 1-9
 - Fields per screen, 1-7
 - Graphics lists, 1-8
 - Languages, 1-9
 - Logs, 1-8
 - Recipes, 1-8
 - Screens, 1-7
 - Scripts, 1-9
 - Tags per screen, 1-7
 - Text lists, 1-8
- Numeric keyboard assignment, 9-12
- Numeric screen keyboard, 9-5, 9-6

O

- OEM applications, 6-16
 - Memory requirements, 6-16
- Offline test, 7-9
- Online languages, 1-9
- Online test, 7-9
- OP option, 6-7
- OPC, 1-9
- Open
 - Combo box, 9-13
 - Tab, 9-15
 - Task Manager, 9-14
 - Windows CE Start menu, 9-14
- Operating a keyboard device, 9-11
- Operating elements, 1-7
 - Alarm view, 9-27
 - Recipe view, 9-31
 - Simple alarm view, 9-29
 - Simple recipe view, 9-35
 - Status/Force, 9-50
 - Trend view, 9-38
- Operating mode
 - Changing, 7-12
 - Offline mode, 7-12
 - Online mode, 7-12
 - Transfer mode, 7-13
- Operating mode switchover, 7-9

- Operating recipes
 - Copying a recipe data record, 10-14
 - Creating recipe records, 10-14
 - Data record transfer, 10-17
 - Delete recipe data record, 10-15
 - Exporting data records, 10-17
 - Import a data record, 10-17
 - Load recipe data record, 10-15
 - Modify recipe record, 10-15
 - Modifying the recipe structure, 10-19
 - Read recipe data record, 10-16
 - Synchronizing recipe tags, 10-15
 - Operating system, 1-1, 1-4, 12-6
 - Navigation, 9-14
 - Updating, 7-17
 - Operating the touch panel, 9-2
 - Operation
 - Bar, 9-37
 - Clock, 9-45
 - Gauge, 9-42
 - Keyboard unit, 9-11
 - Touch objects, 9-2
 - Touch panel unit, 9-2
 - Operator prompting, 1-8
 - Optimization
 - Brightness, 6-7
 - Option
 - Back transfer, 7-22
 - Transfer, 7-21
 - Options
 - Backup battery, 1-10
 - CF card, 1-12
 - Memory card, 1-12
 - PC card, 1-12
 - Overheating, 3-4
 - Overview, 1-1
 - Devices, 1-4
- P**
- Paper size, 6-12
 - Password
 - exporting/importing, 8-8
 - in Runtime, 8-7
 - Path specification
 - Project file, 7-6
 - PC
 - Connecting, 4-15
 - PC card, 1-12, 12-6
 - PCL compatibility, 4-10
 - PE connection, 4-6
 - Permission
 - forcing (remote operation), 9-54
 - Pin assignment, 12-9
 - Pin plug connector, 4-17
 - PLC
 - Connecting, 4-13
 - Plug connections, 3-2
 - Plug-in terminal block, 4-17
 - Port
 - Printer, 6-12
 - Portrait format
 - Printer, 6-12
 - Power cables, 3-2
 - Power consumption, 12-7
 - Power supply, 4-6, 4-17, 12-7
 - Print functions, 1-8
 - Print quality
 - Set, 6-12
 - Printer
 - Connecting, 4-10
 - Set, 6-11
 - Printing
 - Report, 8-5
 - Runtime, 8-8
 - Screen, 8-8
 - Process running phase, 1-4
 - Processor type, 1-4, 12-6
 - Producing
 - Labeling strips, 5-9
 - Product category, 1-1
 - Profiles, 4-1
 - Programming voltage, 1-12
 - Project
 - Back transfer, 7-10
 - Replace, 7-3
 - Test, 7-9
 - Test offline, 7-9
 - Test online, 7-9
 - Project data
 - Load, 7-1
 - ProSave, 7-13
 - Backup, 7-14
 - Integrated, 7-13
 - Restore, 7-16
 - Standalone, 7-13
 - PU
 - Connecting, 4-15
 - PU functions, 1-9
 - Pulse modulation, 12-8

Purpose

- Alarm indicator, 9-25
- Alarm view, 9-26
- Bar, 9-36
- Button, 9-17
- Clock, 9-44, 9-45
- Gauge, 9-42
- I/O field, 9-19
- Icon, 9-55
- Recipe view, 9-31
- Simple alarm view, 9-29
- Simple recipe view, 9-34
- Simple user view, 9-47
- Slider control, 9-40
- Sm@rtClient view, 9-52
- Status/Force, 9-49
- Switch, 9-18
- Trend view, 9-37

Q

Quality

- Graphic printing, 6-12

R

- Radio interference, 12-9
- Radio interference level, 12-9
- Rated voltage, 12-7
- Recipe, 10-2, 10-3
 - Basic principles, 10-2
 - Configuration options, 10-6
 - Configuration settings, 10-6
 - Data record, 10-3
 - Design, 10-2
 - Display in Runtime, 10-1, 10-11
 - exporting, 10-17
 - importing, 10-17
- Recipe record, 10-3
 - Changing, 10-15
 - Copy, 10-14
 - Create on the HMI device, 10-14
 - deleting, 10-15
 - Design, 10-2
 - Editing in WinCC flexible, 10-4
 - exporting, 10-17
 - importing, 10-17
 - Load, 10-15
 - synchronizing, 10-15
 - Transfer, 10-5
 - Transfer options, 10-5
- Recipe screen, 10-13
 - Overview, 10-13

Recipe view, 10-12

- Behavior with screen change, 9-31, 10-13
- Layout, 9-31
- Operating elements, 9-31
- Operation with function keys, 10-13
- Overview, 10-12
- Purpose, 9-31

Recipes, 1-8

Recommissioning

- HMI device, 7-3

Reduce

- Brightness, 6-8
- Contrast, 6-8

Regional setting, 6-13

Relative humidity, 12-8

Remote control

- calling, 9-52
- Forcing permission, 9-54
- of HMI devices, 9-52
- Stop, 9-53

Remote monitoring

- calling, 9-52
- of HMI devices, 9-52
- Stop, 9-53

Remove

- Memory card, 1-13

Report

- in Runtime, 8-5
- Printing, 8-5

Resolution

- Indicators, 1-4, 12-6

Restore, 7-15

Reverse battery protection, 4-17

RF conduction, 12-9

RF irradiation, 12-8

RJ45 plug, 12-11

RTS signal, 4-13

Runtime

- Language switching, 9-1
- Multiple key operation, 9-1
- Operation, 9-1
- Pictograms, 9-2

Runtime software, 7-7

- Load, 7-1

S

Safety, 1-8

- in Runtime, 8-6

Safety notes

- High frequency radiation, 2-1
- Work on the cabinet, 2-1

Scheduler, 1-9

- Screen
 - Printing, 8-8
 - Set brightness, 6-7, 9-13
 - Set contrast, 6-8
 - Templates, 9-2
- Screen change, 5-5
- Screen diagonals, 1-4, 12-6
- Screen keyboard, 9-4
 - Alphanumeric, 9-7, 9-9
 - Numeric, 9-5, 9-6
 - Set, 6-6
- Screen objects
 - in Runtime, overview, 8-1
- Screen objects in runtime
 - Overview, 8-1
- Screensaver, 6-13
- Scripts, 1-9
- Scrolling back
 - Key, 9-12
- Scrolling up
 - Key, 9-12
- Seal, 3-3, 4-3, 4-4
- Selection
 - all, 9-14
 - Input box, 9-15
- Serial printer, 4-10
- Service life
 - Backup battery, 11-2
- Servicing, 11-1
- Set contrast, 6-8
- Set up
 - Network, 6-18
 - Printer, 6-11
- Settings
 - Brightness, 6-7, 6-8, 9-13
 - Contrast, 6-7, 9-13
 - Date/time, 6-5
 - Language, 7-11
 - Network, 6-6
 - Printer, 6-11
 - Regional, 6-13
 - Save, 6-9
 - Screen keyboard, 6-6
 - Touch calibration, 6-7, 6-8
 - Volume, 6-17
- SHIFT
 - Key, 9-12
- Shift layer
 - Screen keyboard, 9-9
- Shift+Alt-Gr layer
 - Screen keyboard, 9-9
- Shock loading, 12-8
- Signal lines, 3-2
- Signal tone, 6-17
- SIMATIC 500/505 DP, 1-9
- SIMATIC 500/505 serial, 1-9
- SIMATIC HMI HTTP Protocol, 1-9
- SIMATIC S5 AS511, 1-9
- SIMATIC S5 DP, 1-9
- SIMATIC S7-200, 1-9
- SIMATIC S7-300/400, 1-9
- SIMATIC WinAC, 1-9
- SIMOTION, 1-9
- Simple alarm view
 - Layout, 9-29
 - Operating elements, 9-29
 - Purpose, 9-29
- Simple recipe view
 - Behavior, 9-34
 - Layout, 9-34
 - Operating elements, 9-35
 - Purpose, 9-34
- Simple user view
 - Layout, 9-47
 - Purpose, 9-47
- Size
 - Paper, 6-12
- Slider control
 - Layout, 9-40
 - Purpose, 9-40
- Slot A, 1-12
- Slot B, 1-12
- Sm@rtClient view
 - Behavior, 9-52
 - Control mode, 9-53
 - Layout, 9-52
 - Monitoring mode, 9-53
 - Purpose, 9-52
- Softkey, 5-5
 - Labeling, 5-7
 - LED, 5-5
 - Remote control, 9-54
- Software, 12-6
- Software options, 1-14
- Source file
 - Memory location, 7-7
- Special characters
 - Key, 9-12
- Spring terminal, 4-2, 4-3
- Spring terminal, 4-2, 4-3
- Standalone ProSave
 - Backup, 7-14
- Standard cables, 4-15
- Standard layer
 - Screen keyboard, 9-9
- Start screen, 7-2
- Start up, 7-1
- Static discharge, 12-8

- Status/Force
 - Layout, 9-50
 - Operating elements, 9-50
 - Purpose, 9-49
- Stop
 - Remote control and monitoring, 9-53
- Storage location
 - Project file, 7-7
 - Runtime software, 7-7
 - Source file, 7-7
- Sub-D plug, 12-9, 12-10
- Sub-D socket, 12-10
- Sunlight, 3-4
- Supply source
 - Backup battery, 11-2
- Surge coupling, 12-9
- Switch
 - For 1F1B interface, 4-13
 - Layout, 9-18
 - Purpose, 9-18
- Switch off
 - Back-lighting, 6-13
 - Power supply, 1-13
- Switch settings
 - Interface IF1B, 4-13
- Symbolic I/O field
 - Purpose, 9-23
- Synchronization
 - With controller, 10-7
- synchronizing, 6-5
- Synchronizing
 - Recipe record, 10-15
- Synchronizing recipe tags, 10-15
- System alarms, A-3
 - Meaning, A-4
 - Parameters, A-4
- System function, 10-5
 - to transfer of recipe data records, 10-5
- System keys, 1-4, 5-3, 5-4, 5-6
- System settings, 6-2

T

- Tab
 - Key, 9-12
- TAB
 - Key, 9-12
- Tags
 - in Runtime, 8-3
- Task Manager, 9-14
- Technical data, 12-5

Test

- Network, 6-20
- Project, 7-9
- Test project
 - Offline, 7-8
 - On the configuration computer, 7-8
 - Online, 7-8
- Thickness
 - Front panel, 3-3, 3-5, 3-6
- Time, 6-5, 7-2
- Time zone, 6-5
- Toggle
 - Key, 9-12
- Torque, 4-3, 4-4
- Touch control
 - Date/time field, 9-43
 - I/O field, 9-20
- Touch objects
 - Using, 9-2
- Touchscreen
 - Calibration, 6-8
- Trademarks, v
- Transfer, 10-5
 - Of recipe data records, 10-5
 - Options, 7-4
 - Start manually, 7-3
- Transfer mode, 9-14
- Transients, 12-7
- Trend view
 - Layout, 9-38
 - Operating elements, 9-38
 - Purpose, 9-37

U

- UL approval, A-1
- Unit dimensions
 - MP 270B 10" Keys, 12-3
 - MP 270B 10" Touch, 12-1
 - MP 270B 6" Touch, 12-2
 - OP 270 10 inch, 12-3
 - OP 270 6 inch, 12-4
 - TP 270 10", 12-1
 - TP 270 6", 12-2
- Update operating system
 - With Booting, 7-18
 - Without Booting, 7-17
- Updating
 - Date/time, 7-2
 - Operating system, 7-17

- UPS, 6-16
- USB hub, 4-10, 4-12
- USB interface, 4-11
 - Assignment, 12-11
- USB keyboard, 5-12
- USB mouse, 5-12
- Use with additional measures, 3-2
- User data
 - exporting/importing, 8-8
- User group
 - in Runtime, 8-7
- User groups
 - Number, 1-8
- User view, 9-45
 - Export, 9-46
 - Import, 9-46
 - Layout, 9-45
 - Purpose, 9-45
- Users
 - in Runtime, 8-7
 - Number, 1-8

V

- VBScript, 1-9
- Ventilation slots, 3-4
- Vibration, 12-8
- Visual feedback, 9-3

W

- Weight, 12-6
- WinCC flexible, 1-3
 - Backup, 7-15
 - Restore, 7-16
- Windows CE, 1-1, 6-2, 12-6
- WINS server, 6-18
- Work on the cabinet, 2-1
- Working memory, 12-6

