

**1 YEAR**  
WARRANTY

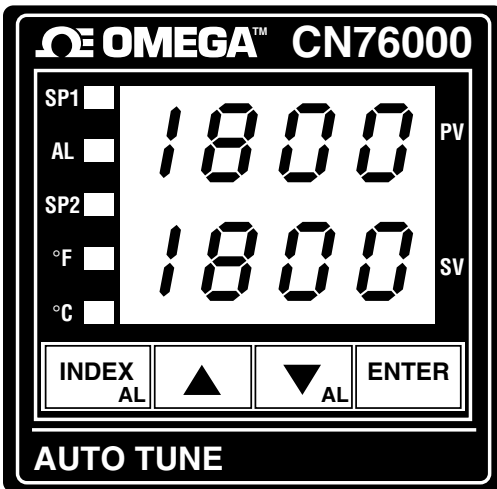

# Ω OMEGA™ User's Guide



*Shop online at  
[omega.com](http://omega.com)*

*e-mail: [info@omega.com](mailto:info@omega.com)  
For latest product manuals:  
[www.omegamanual.info](http://www.omegamanual.info)*

## **CN76000** **Microprocessor-Based** **Temperature/Process** **Controller**



omega.com info@omega.com

**Servicing North America:**

**U.S.A.  
Headquarters:**

Omega Engineering, Inc.

Toll-Free: 1-800-826-6342 (USA & Canada only)

Customer Service: 1-800-622-2378 (USA & Canada only)

Engineering Service: 1-800-872-9436 (USA & Canada only)

Tel: (203) 359-1660

Fax: (203) 359-7700

e-mail: info@omega.com

**For Other Locations Visit [omega.com/worldwide](http://omega.com/worldwide)**

## Table of Contents

UNPACKING .....	2
INSTALLATION .....	2
DIMENSIONS .....	2
INPUT SELECTION .....	3
OUTPUT TYPE JUMPER SELECTION .....	3
INPUT WIRING .....	4
FRONT PANEL KEY FUNCTIONS .....	7
METHOD FOR SET UP OF A HEAT / COOL CONTROL .....	7
SECURITY LEVEL SELECTION .....	8
MENU SELECTIONS .....	8
PRIMARY MENU .....	8
SECURE MENU .....	9
SECONDARY MENU .....	13
DIAGNOSTIC ERROR MESSAGES .....	17
CONFIGURATION MENU .....	19
CONFIGURATION CHART .....	20
SPECIFICATIONS .....	21

## GETTING STARTED

1. Install the instrument as described on page 2.
2. Make sure that the input DIP switch is set correctly for the input you wish to use. Instructions are on page 3. Factory defaults are set for thermocouple input.
3. Identify the model number to verify output type. If necessary, change the output jumper. Refer to the instructions on page 3.
4. Wire your instrument following the drawings on pages 4 and 5.
5. Make any programming changes necessary in the Secure and Secondary Menus. DO NOT make changes to the Configuration Menu unless specifically instructed. If you need to back up in a menu, press the INDEX and DOWN ARROW keys together.
6. To quickly return to the HOME position, press the UP ARROW and ENTER keys together, and then the INDEX and DOWN ARROW keys.

## HOW TO USE THIS BOOK

Because of the number of features available in this instrument, information is included that may not apply to your specific instrument. Options, for example, are included in this book, but may not be included in your instrument. To increase clarity the following conventions are used:

Optional features or functions are shown in this book in *Roman type*. The Option code (from the configuration menu) is listed after the menu item in parenthesis. If you do not have an option installed, you may skip any items listed in *Roman type*.

Options are referred to by the configuration code(s) and not the ordering code(s). Use the following cross reference (ordering code = configuration code):

- PV	=	936	Process variable output 0 to 10 Vdc.
- 4SP	=	948	Four Stage Set Point selectable via contact closures at the rear of the control.
- 485	=	992	RS-485 Serial Communication.

OMEGALLOY® is a registered trademark of OMEGA ENGINEERING, INC.  
CHROMEGA® is a registered trademark of OMEGA ENGINEERING, INC.  
ALOMEGA® is a trademark of OMEGA ENGINEERING, INC.

## UNPACKING

Remove the packing list and verify that all equipment has been received. If there are any questions about the shipment, please call OMEGA Customer Service Department at 1-800-622-2378 or (203) 359-1660.

Upon receipt of the shipment, inspect the container and equipment for any signs of damage. Take particular note of any evidence of rough handling in transit. Immediately report any damage to the shipping agent.

### NOTE

The carrier will not honor any claims unless all shipping material is saved for their examination. After examining and removing contents, save packing material and carton in the event reshipment is necessary.

## INSTALLATION

Mount the instrument in a location that will not be subject to excessive temperature, shock, or vibration. All models are designed for mounting in an enclosed panel.

Select the position desired for the instrument on the panel. If more than one instrument is required, only two units can be mounted closely together, either one above the other or side by side. When mounted together, the mounting collar will require modification by removing the inside tab from each collar.

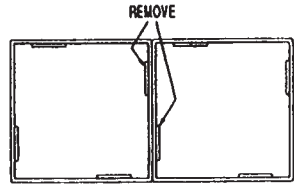

Prepare the panel by cutting and deburring the required opening.

From the front of the panel, slide the housing through the cut out. The housing gasket should be against the housing flange before installing.

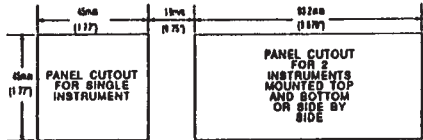

ALL TOLERANCES ARE  
0.00 +0.25mm (-0.000 +0.010)

From the rear of the panel slide the mounting collar over the housing. Hold the housing with one hand and using the other hand, push the collar evenly against the panel until the spring loops are slightly compressed. The ratchets will hold the mounting collar and housing in place.

## DIMENSIONS

(ALL DIMENSIONS IN MM WITH INCHES IN PARENTHESIS)

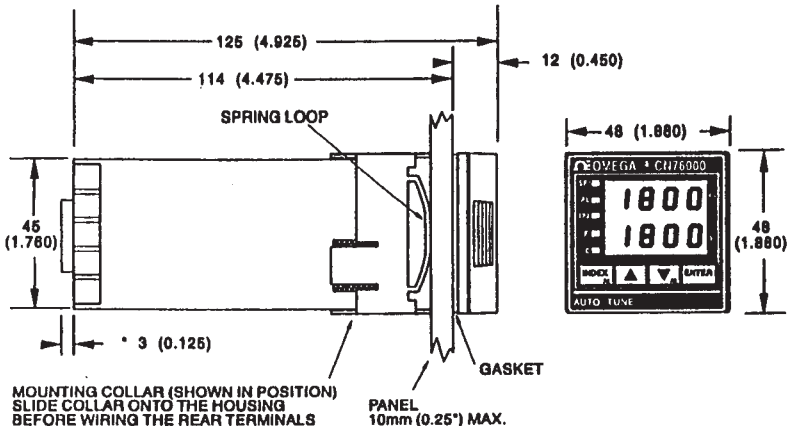

MOUNTING COLLAR (SHOWN IN POSITION)  
SLIDE COLLAR ONTO THE HOUSING  
BEFORE WIRING THE REAR TERMINALS

PANEL  
10mm (0.25") MAX.

PANEL CUTOUT FOR ALL MODELS 45 MM X 45 MM (1.775" X 1.775")  
ALLOW FOR 13 MM (0.5") CLEARANCE AT THE REAR OF INSTRUMENT.  
\* PRESENT FOR ALL OUTPUTS EXCEPT RELAY.

## INPUT SELECTION

To change the input type, remove the instrument from its housing. Grasp the front bezel sides and pull forward to release it from the housing lock. Locate the dip switch on the right pcb. Determine the input type desired and change the dip switch setting as shown to the right.

**NOTE :** Factory default is set for thermocouple inputs.

After changing input selection with the DIP switches, be sure to change the InP menu item (page 9) in the Secure Menu.

**NOTE:** InP menu item factory default is set for type "J" thermocouple, Iron/Constantan

Scaling for thermocouple and RTD inputs is fixed for each range type. See page 8 for scale ends.

Scaling for current and voltage inputs is field adjustable by using SCAL and SCAH in the Secure menu. Program SCAL to the low end value of your transmitter. Program SCAH to the high end value of your transmitter. If the span of your transmitter is less than 100 units (referred to as 'counts' in these instructions), multiply the transmitter span by 10 and change the decimal point position in menu item dP.

For example, if you have a differential pressure transmitter with a range of -0.25 to +0.25 inches of water. SCAL would be programmed to -250, SCAH to +250, and dP to 0.000.



**VERIFY MODEL NUMBER ON THE INSTRUMENT TO DETERMINE OUTPUT TYPE PRE-SET FROM FACTORY.**

## OUTPUT TYPE JUMPER SELECTION

Instruments with SSR or MECHANICAL RELAY type outputs can be changed to and from a 5 Vdc output in the field.



**CAUTION:** Damage to the instrument may result from an incorrectly installed jumper strip. Follow the instructions carefully.

1. Remove the instrument from its housing. Grasp the front bezel sides and pull forward to release it from the housing lock.
2. Locate the desired logic jumper strip on the left printed circuit board. The OUTPUT A jumper strip is always located near the top edge.

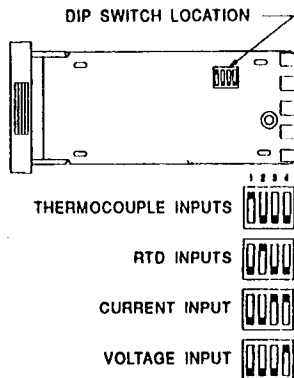
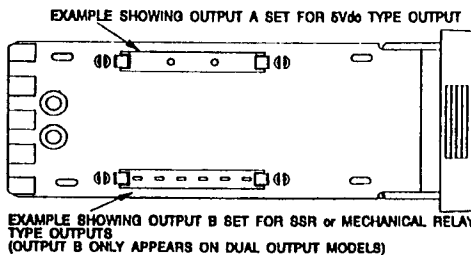

To remove the logic jumper strip, carefully insert a small flat blade screwdriver between the retaining clip and the jumper at one end of the jumper strip. Apply slight pressure to move the clip away from the jumper end until it is released, then lift it up and out of the clip.

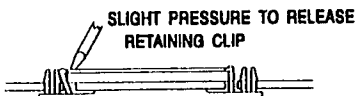

To re-install the jumper strip, hold it with the spring contacts in the desired position. Face springs up for **SSR** or **MECHANICAL RELAY** outputs, or face springs down for **5 Vdc** outputs. Insert one end of the jumper strip under the retaining clip and press the other end down until the remaining clip engages the jumper.

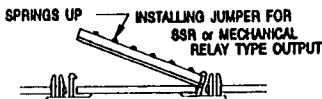
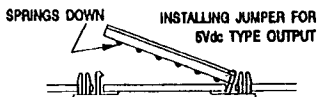

To avoid any damage, recheck the jumper installation and the housing rear terminal panel output wiring.

Replace the instrument into its housing.

## INPUT WIRING

Do not run thermocouple or other input wiring in the same conduit as power leads. Use only the type of thermocouple or RTD probe for which the control has been programmed. See the "Secure Menu" for input selection.

For thermocouple input always use extension leads of the same type designated for your thermocouple.

# AC SOLID STATE RELAY OUTPUT WIRING

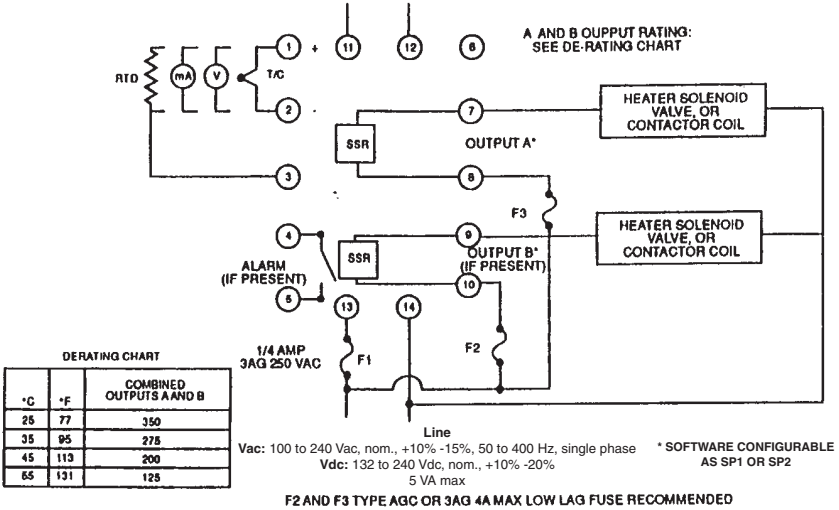

# MECHANICAL RELAY OUTPUT WIRING

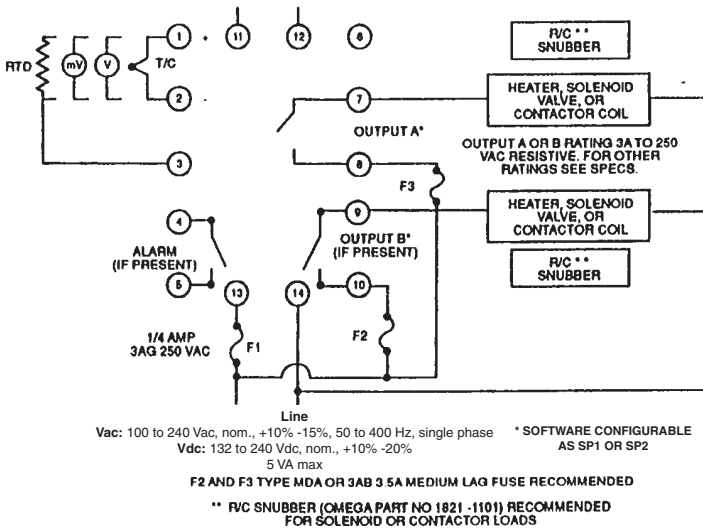

## 5 VDC OUTPUT WIRING

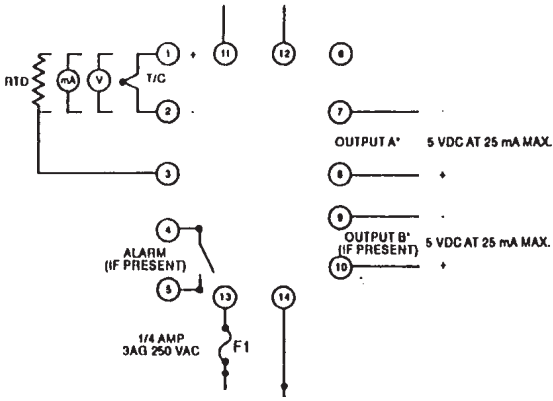

Vac: 100 to 240 Vac, nom., +10% -15%, 50 to 400 Hz, single phase  
 Vdc: 132 to 240 Vdc, nom., +10% -20%  
 5 VA max

\* SOFTWARE CONFIGURABLE AS SP1 OR SP2

CAUTION: OUTPUT MUST NOT SHARE A COMMON GROUND WITH INPUT

## CURRENT OR VOLTAGE OUTPUT

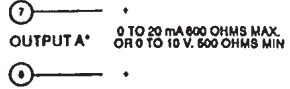

OUTPUT A\* 0 TO 20 mA 600 OHMS MAX.  
 OR 0 TO 10 V, 500 OHMS MIN

## OPTIONS

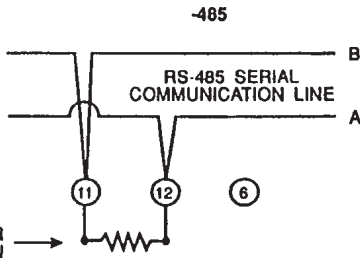
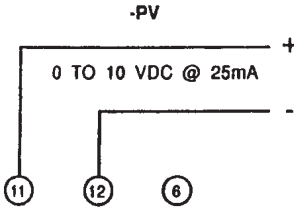
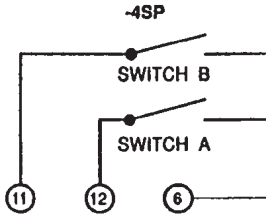

INSTALL 121 OHM RESISTOR ON LAST CONTROL IN CHAIN →



## FRONT PANEL KEY FUNCTIONS

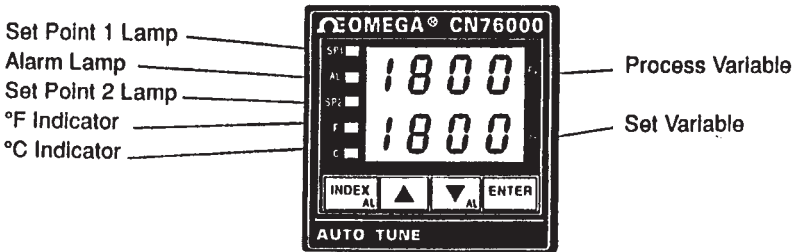

1. **INDEX:** Pressing the INDEX key advances the display to the next menu item. May also be used in conjunction with other keys as noted below.
2. **UP ARROW:** Increments a value, changes a menu item, or selects the item to ON in the upper display.
3. **DOWN ARROW:** Decrements a value, changes a menu item, or selects the item to OFF in the upper display.
4. **ENTER:** Pressing ENTER stores the value or the item changed. If not pressed, the previously stored value or item will be retained.
5. **UPARROW & ENTER:** Pressing these keys simultaneously brings up the **Secondary menu** starting at the auto/manual selection. Pressing these keys for 5 seconds will bring up the **Secure menu**.
6. **INDEX & DOWN ARROW:** Pressing these keys simultaneously will allow backing up one menu item, or if at the first menu item they will cause the display to return to the **Primary menu**.
7. **INDEX & ENTER:** Pressing these keys simultaneously and holding them for 5 seconds allows recovery from the various error messages. The following menu items will be reset:

**LPbr:** Loop break

**SEnC:** Sensor rate of change

**ALIH:** Alarm inhibit

**OPEn InP:** Open Input error message

**bAd InP:** Bad Input error message

**ArEA:** Area error message

**CHEC CAL:** Check calibration error message

Correct the problems associated with the above conditions first before using these reset keys. More than one error could be present. Caution is advised since several items are reset at one time.

While in the **Primary** or **Secondary menu**, if no key is pressed for a period of 30 seconds, the display will return to the **HOME** position displaying the PV and SV values. The time is increased to 1 minute when in the **Secure menu**.

**NOTE:** To move to the **Primary menu** quickly from any other menu, press the **UP ARROW & ENTER** keys followed by pressing the **INDEX & DOWN ARROW** keys.

## METHOD FOR SET UP OF A HEAT / COOL CONTROL WITH SELF TUNE

Determine if the process is predominantly heating or cooling. An extruder, for example, is predominantly cooling when running product. An environmental chamber can be either heating or cooling. (For explanation of menu items see pages 12 & 13.)

If the process is predominantly cooling, set S1St to dir and S2St to rE. If the process is predominantly heating, set S1St to rE and S2St to dir. Redirect SP1 to output A or B as

required by the hardware (see SP1o). Set S2t to dE. Set SP2 for zero (no overlap of bands, no deadband). Set Pb2 to a desired value (default is 12° F). Set tunE to SELF, S1rt to YES, and LErn to End.

Start the process and wait for it to come to stability. Occasionally check that the Self Tune has completed the learning process by INDEXing to S1rt in the secondary menu. If the YES value has changed to no, then the process has been learned. Once learning is complete, you may adjust SP2 to either overlap the SP1 band (SP2 value less than zero), or add some separation between them (deadband — SP2 greater than zero) if required to optimize control.

## SECURITY LEVEL SELECTION

Four levels of security are provided in the CN76000 menu system. The display shows the current security level. The level determines which menus are locked preventing changes in menu item in those menus. To change security levels, change the password value using the **UP & DOWN ARROW** keys and pressing the **ENTER** key. Refer to the password table below for the correct value to enter for the security level desired. The **SECr** menu item security level may be viewed or changed at any time regardless of the present security level. The password values shown in the table cannot be altered, so retain a copy of this page for future reference. This will be the only reference made to password values in this instruction book.

**PASSWORD TABLE**

SECURITY LEVEL MENU SECURITY	DISPLAYED VALUE WHEN VIEWED	PASSWORD VALUE TO ENTER
Primary Locked Secondary Locked Secure Locked	1	1110
Primary Unlocked Secondary Locked Secure Locked	2	1101
Primary Unlocked Secondary Unlocked Secure Locked	3	1011
Primary Unlocked Secondary Unlocked Secure Unlocked	4	111

## MENU SELECTIONS

### PRIMARY MENU

Press **INDEX** to scan the Lower Display. Press **UP ARROW** or **DOWN ARROW** to change the value in the upper display.

*In the following, the symbol "#" will be used before a letter in a menu item to indicate the set point value to be viewed and/or modified. (Applies to Option 948 only.)*

**#SP1** (948) or  
Set Point 1, Main Control Point.

Set Point 2, if equipped.

## SECURE MENU

Hold **UP ARROW & ENTER** for 5 Seconds to display the Secure menu. Press **INDEX** to change the lower display. Press **UP ARROW** or **DOWN ARROW** to change the value in the upper display. Press **ENTER** to store the value.

### Selections

- SECr** Security Code: See the Security Level Selection and the Password Table in this manual, in order to enter the correct password.
- InP** Input Type: Select one of the following. The Inputs are based on four different groups; Thermocouples, RTDs, Current, and Voltage. If changing from one of these groups, the DIP switch on the A/D circuit board will have to be changed to match that particular group. Refer to the Input wiring section for the proper switch settings.
- J-IC** Type "J" Thermocouple, Iron/Constantan (NIST)
  - CA** Type "K" Thermocouple CHROME<sup>®</sup>GA<sup>®</sup>/ALOMEGA<sup>®</sup>
  - E-** Type "E" Thermocouple CHROME<sup>®</sup>GA<sup>®</sup>/Constantan
  - t-** Type "T" Thermocouple Copper/Constantan
  - L-** Type "L" Thermocouple Iron/Constantan (DIN)
  - n-** Type "N" Thermocouple Nicrosil/Nisil
  - r-13** Type "R" Thermocouple Pt 13%Rh/Pt
  - S-10** Type "S" Thermocouple Pt 10%Rh/Pt
  - b-** Type "B" Thermocouple Pt 6%Rh/Pt 30%Rh
  - C-** Type "C" Thermocouple W 5%Re/W 26%Re
  - P392** 100 ohm Platinum (NIST 0.00392  $\Omega/\Omega/^\circ\text{C}$ )
  - n120** 120 ohm Nickel (NIST 0.006  $\Omega/\Omega/^\circ\text{C}$ )
  - P385** 100 ohm Platinum (DIN 0.00385  $\Omega/\Omega/^\circ\text{C}$ )
  - Curr** DC Current Input 0.0 to 20.0 or 4.0 to 20.0 milliamperes.
  - VolL** DC Voltage Input 0.0 to 5.0 or 1.0 to 5.0 volts.
  - For Access to Calibration and FACt dFLt.
- OSUP** Zero Suppression: Select **On** or **OFF**. Only with Current and Voltage input types.  
**OFF** The input range will start at 0 (zero) input.  
**On** The input range will start at 4.00 mA or 1.00 V.
- Unit** F, C or None  
**F** °F descriptor is On and temperature inputs will be displayed in actual degrees Fahrenheit.  
**C** °C descriptor is On and temperature inputs will be displayed in actual degrees Celsius.  
**none** °F and °C descriptors will be Off. This is only available with Current and Voltage inputs.
- dPt** Decimal Point Positioning: Select **0**, **0.0**, **0.00**, or **0.000**. On temperature type inputs this will only effect the Process Value, SP1, SP2, ALLo, ALHi, and InPC. For Current and Voltage inputs all Menu items related to the input will be affected.  
**0** No decimal point is selected. This is available for all input types.  
**0.0** One decimal place is available for Type J, K, E, T, L, RTDs, Current and Voltage inputs.  
**0.00** Two decimal places is only available for Current and Voltage inputs.  
**0.000** Three decimal places is only available for Current and Voltage inputs.
- InPt** Input Fault Timer: Select **OFF**, **0.1** to **540.0** minutes. Whenever an input is out of range, shorted, or open the timer will start. When the time has elapsed, the controller will revert to a safe condition (Outputs Off, Flashing Displays). If **OFF** is selected, the Input Fault Timer will not be recognized (time = infinite).

## SECURE MENU (cont'd)

- SEnC** Sensor Rate of Change: Select **OFF**, **1** to **4000** °F, °C, or counts per 1 second period. This value is usually set to be slightly greater than the fastest process response expected during a 1 second period, but measured for at least 2 seconds. If the process is faster than this setting, the **SEnC** bAd error message will appear. The outputs will then be turned off. This function can be used to detect a runaway condition, or speed up detection of an open thermocouple. Use the **INDEX & ENTER** keys to reset.
- SCAL** Scale Low: Select **100** to **9999** counts below **SCAH**. The total span between **SCAL** and **SCAH** must be within 11998 counts. Maximum setting range is -1999 to +9999 counts. For Current and Voltage Inputs, this will set the low range end. Value fixed for Thermocouples and RTD ranges.
- SCAH** Scale High: Select **100** to **9999** counts above **SCAL**. The total span between **SCAL** and **SCAH** must be within 11998 counts. Maximum setting range is -1999 to +9999 counts. For Current and Voltage inputs, this will set the high range end. Value fixed for Thermocouples and RTD ranges.
- SPL** Set Point Low: Select from **SCAL** value to **SPH** value. This will set the minimum **SP1**, **SP2**, **ALLo**, **ALHi**, **SP1d**, and **SP2d** values that can be entered. If any of the values are less than the **SPL** value, a check message will appear and the value will not be accepted.
- SPH** Set Point High: Select from **SCAH** value to **SPL** value. This will set the maximum **SP1**, **SP2**, **ALLo**, **ALHi**, **SP1d**, and **SP2d** values that can be entered. If any of the values are greater than the **SPH** value, a check message will appear and the value will not be accepted.
- SP1o** Set Point 1 Output Terminal Assignment: Select **OutA** or **Outb**.  
**NOTE:** Reassigning the output terminals does not change the Hardware type assigned to those terminals. For single set point models, **SP1o** is locked to **OUT A**.  
**OutA** Set Point 1 output will be directed to terminals 7 & 8 and Set Point 2 output to terminals 9 & 10.  
**Outb** Set Point 1 output will be directed to terminals 9 & 10 and Set Point 2 output to terminals 7 & 8.
- S#O1** Set Point Output Type: Select **CY**, **OnOF**, **PUL**, or **Ft**. Fixed for Current and Voltage, the Hardware Configuration has selected this.  
**CY** Cycle Rate, Adjustable Time Proportioning.  
**CY#** Cycle Rate Time: Select **2** to **80** seconds.  
**OnOF** On/Off Output.  
**SP#d** Set Point Differential in 1 degree or count steps from 2 degrees or counts to full scale, but limited by **SPL** and **SPH**.  
**PUL** Pulse Time Proportioning.  
**PUL#** Pulse Width Value: Select **1** to **7**.  
**Ft** Fast Time Proportioning: Fixed at 1 second Time Base.  
**Volt** Proportional Voltage, 0 to 10 V.  
**Curr** Proportional Current, 0 to 20 mA.
- S#St** Set Point State: Select **dir** or **rE**.  
**dir** Direct Action. As the input increases the output will increase. Most commonly used in cooling processes.  
**rE** Reverse Action. As the input increases the output will decrease. Most commonly used in heating processes.
- S#OL** Set Point Output Low Limit: Select **0** to **90%** but less than **S#OH**. This item limits the lowest output value. This is useful for adding a bias to the process when needed. When a current or voltage output is used, the standard output value is 0 to 20mA or 0 to 10V. If 4 to 20 mA or 2 to 10 V is required, the **S#OL** value should be set for 20% to raise the lowest output.
- S#OH** Set Point Output High Limit: Select **10** to **102%** but greater than **S#OL**. This item allows setting the maximum output limit. This is useful with processes that are over powered.

## SECURE MENU (cont'd)

**S#LP** Set Point Lamp: Select **O** on or **OoFF**.  
**O on** Lamp ON when Output is ON.  
**OoFF** Lamp OFF when Output is ON.

**S2t** Set Point 2 type: Select **Abs** or **dE**.

**Abs** Absolute SP2. SP2 is independent of SP1, and may be set anywhere between the limits of SPL and SPH.

**dE** Deviation SP2. SP2 is set as a deviation from SP1, and allows SP2 to retain its relationship with SP1 when SP1 is changed (tracking SP2).

### ALARM TYPE AND ACTION (If present)



**CAUTION:** In any critical application where failure could cause expensive product loss or endanger personal safety, a redundant limit controller is recommended.

When setting an alarm value for an absolute alarm ( $ALt = Abs$ ), simply set the alarm to the value at which the alarm is to occur.

When setting the alarm value for a deviation alarm ( $ALt = dE$ ), set the alarm to the value equal to the difference in value between the desired alarm and Set Point 1. For example if a low alarm is required to be 5 degrees below SP1, then set  $ALLo$  to -5. If a high alarm is required 20 degrees above SP1, then set  $ALHi$  to +20. If SP1 is changed, the alarm will continue to hold the same relationship as originally set.

The following diagram shows the action and reset functions for both absolute and deviation alarms.

When "Alarm Power Interrupt" ALPI is programmed ON and "Alarm Reset" is programmed for Hold, the alarm will automatically reset upon a power failure and subsequent restoration if no alarm condition is present.

If "Alarm Inhibit" ALIH is selected ON, an alarm condition is suspended upon power up until the process value passes through the alarm set point once. Alarm inhibit can be restored as if a power up took place by pressing together the INDEX and ENTER keys for 5 seconds.



**WARNING:** Resetting a high alarm inhibit will not allow an alarm to occur if the Process Value does not first drop below the high alarm setting. Do not use the Alarm Inhibit feature if a hazard is created by this action. Be sure to test all combinations of high and low alarm inhibit actions before placing control into operation.

### ABSOLUTE ALARMS

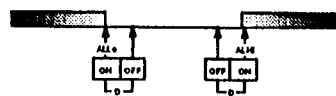
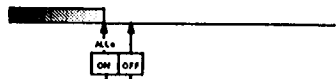
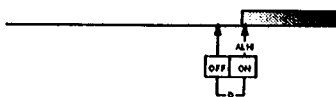

### DEVIATION ALARMS

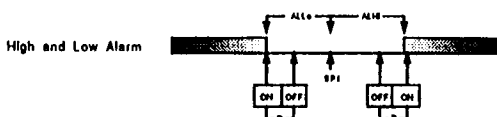
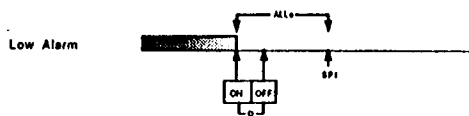
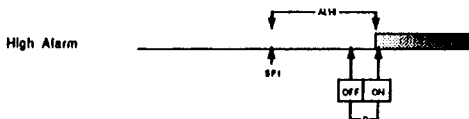

## SECURE MENU (cont'd)

The following Secure menu Items appear only if the Instrument has the alarm option.

Alarms: Select **OFF**, **Lo**, **Hi**, or **HILo**.

**OFF** Alarms are turned OFF. No Alarm menu items appear in the Secondary and Secure menus.

**Lo** Low Alarm Only. **ALLo** appears in the Secondary Menu.

**Hi** High Alarm Only. **ALHi** appears in the Secondary Menu.

**HILo** High and Low Alarms. Both share the same Alarm Relay output.

Alarm Type: Select **AbS** or **dE**

**AbS** Absolute Alarm that may be set anywhere within the values of SPL and SPH and is independent of SP1.

**dE** Deviation Alarm that may be set as an offset from SP1. As SP1 is changed the Alarm Point will track with SP1.

**ALrE** Alarm Reset: Select **OnOF** or **Hold**.

**OnOF** Automatic Reset.

**Hold** Manual Reset. Acknowledge by simultaneously pressing the **INDEX & DOWN ARROW** keys for 5 seconds.

**ALPI** Alarm Power Interrupt: Select **On** or **OFF**. This resets an alarm on power on if no alarm is present.

**On** Alarm Power Interrupt is ON. Alarms will reset at power on.

**OFF** Alarm Power Interrupt is OFF. Alarms will not reset.

**ALIH** Alarm Inhibit: Select **On** or **OFF**.

**On** Alarm Inhibit is ON. Alarm action is suspended at power up or after reset until the process value first enters a non-alarm condition.

**OFF** Alarm Inhibit is OFF. Alarm action is not suspended.

**ALSt** Alarm Output State: Select **CLOS** or **OPEn**.

**CLOS** Closes Contacts at Alarm Set Point.

**OPEn** Opens Contacts at Alarm Set Point.

**ALLP** Alarm Lamp: Select **O on** or **OoFF**.

**O on** Alarm Lamp is ON when alarm contact is closed.

**OoFF** Alarm Lamp is OFF when alarm contact is closed.

**ALbr** Alarm Loop Break: Select **On** or **OFF**.

**On** Loop Break Condition will cause an Alarm Condition.

**OFF** Loop Break will not affect the Alarm Condition.

The following Secure menu Items apply only to Options. They may not appear in your Instrument.

**SPSA** Set Point Select Action (948): Select **rE** or **Int**.

**rE** Remote (external) selection of active set point value.

**Int** Internal selective of active set point value.

**Addr** Control Address (992): Set from 1 to FF. This number (hexadecimal, base 16) must match the address number used by the host computer.

**baUD** Communications baud rate (992): Select 300, 1200, 2400, 4800, 9600, 19.2, 28.8, or 57.6. This number must match the baud rate used by the host computer. The data format is 8 bits, 1 stop bit, No parity.

No Activity Timer (992): Select **OFF** to 99. If a number is set, the control will expect access by the host computer. If no access is detected within that time, the control will indicate an error, **CHEC LorE** and go to the set point indicated by **CFLt**.

**CFLt** Communication Fault Mode (992): Select 1 or 2. 1 = On Communication fault, use local Set Point. 2 = On Communications fault, use **CFSP**.

## SECONDARY MENU

Hold **UP ARROW & ENTER** to display the Secondary menu. Press **INDEX** to scan the Lower Display. Press **UP ARROW** or **DOWN ARROW** to change the value in the upper display. Press **ENTER** to store the value.

### Selections

**Auto** Auto/Manual Control: Select On or OFF.

**On** Automatic Control

**OFF** Manual Control is enabled. The lower display in the HOME position will display the output in percent for SP1 or SP2, and is adjustable for each from 0.0 to 100 percent. SP1 appears first with a flashing "o" on the right hand corner of the lower display to represent percent. Press **INDEX** to display SP2 output. A flashing "δ" will appear on the right hand corner of the lower display to represent percent. When Manual is enabled, the present control outputs are held (bumpless transfer) and displayed. The output for SP1 or SP2 can then be manually adjusted while displayed by pressing the **UP** or **DOWN Arrow** key to change the value, and then the **ENTER** key. The Upper display will normally indicate the Process Value. Since Manual will override most fault messages the upper display could indicate a fault message. Refer to the Diagnostic Error Message Section for further explanation.

**ALLo** Alarm Low: The Low Alarm point is usually set below the Main Set Point.

**ALHI** Alarm High: The High Alarm Point is usually set above the Main Set Point.

**SP** Active set point (948): Select **1SP1, 2SP1, 3SP1, or 4SP1**. Allows setting of the multiple stages of SP1, and SP1 tuning constants.

**#SP1** Set Point Value # (948): Select desired value.

**#tun** (948) or

**tunE** Tuning Choice: Select **SELF, Pid, SLO, nor, or FAST**.

**SELF** The Controller will evaluate the Process and select the PID values to maintain good control. Active for SP1 only.

**Strt** Select **YES** or **no**

**YES** Start Learning the Process. After the process has been learned the menu item will revert to **no**.

**no** Learning will stay in present mode.

**LErn** Select **Cont** or **End**

**Cont** Continuously adjust the PID values to maintain the best control. The Process is being monitored at all times by collecting and analyzing the data to adjust the PID values. (adaptive control).

**End** The Process data is collected once and then the PID values are saved, tuning is stopped.

**dFAC** Damping factor, Select **OFF, 1 to 7**. Sets the ratio of Rate to Reset for the **SELF** **tunE** mode. **7 = most Rate**. Factory set to **3**. For a fast response process the value should be lowered (less Rate). For a slower process the value should be increased (more Rate).

**Pid** Manually adjust the PID values. PID control consists of three basic parameters, Proportional Band (Gain), Reset Time (Integral), and Rate Time (Derivative).

**#Pb1** (948) or

**Pb1** Proportional Band (Bandwidth). Select **6 to 5000 °F, 3 to 2778 °C, or 6 to 9999 counts**.

**Pb2** Proportional Band (Bandwidth). Select **6 to 5000 °F, 3 to 2778 °C, or 6 to 9999 counts**. (*Appears after #rTE when Option 948 is selected.*)

**#rES** (948) or

**rES** Automatic Reset Time. Select **OFF, 0.1 to 99.9 minutes**. Select **OFF** to switch to **OFS**.

**#OFS** (948) or

**OFS** Manual Offset Correction Select **OFF, 0.1 to 99.9%**. Select **OFF** to switch to **rES**.

**#rtE** (948) or

**rtE** Rate Time. Select **OFF, 0.01 to 99.99 minutes, Derivative**.

**SECONDARY MENU (cont'd)**

- SLO** PID values are preset for a slow response process.
- nor** PID values are preset for a normal response process.
- FAST** PID values are preset for a fast response process.

**Pid2** Linkage of PID parameters between SP1 and SP2: Select **On** or **OFF**.  
**On** Links SP2 to SP1 or #SP1 rEs and rIE terms for heat/cool applications.  
**OFF** Sp2 functions without rEs and rIE.

**ArUP** Anti-Reset Wind-up Feature: Select **On** or **OFF**.  
**On** When ArUP is **On** the accumulated Reset Offset value will be cleared to 0% when the process input is not within the Proportional Band.  
**OFF** When ArUP is **OFF**, the accumulated Reset Offset Value is retained in memory when the process input is not within the Proportional Band.

**ArE** Approach Rate Time: Select **OFF**, **0.01** to **99.99** minutes. The function defines the amount of Rate applied when the input is outside of the Proportional Band. The ArE time and the rIE time are independent and have no effect on each other. To increase damping effect and reduce overshoot set the approach rate time for a value greater than the natural rise time of the process (natural rise time = process value time to set point).

**PEA** The Peak feature will remember the highest input the Instrument has had since the last reset or Power On. At Power On it is reset to the present input. To manually reset the value, PEA must be in the lower display and then press the **ENTER** key. This will cause PEA to be reset to the present input value.

**UAL** The Valley feature will remember the lowest input the Instrument has had since the last reset or Power On. At Power On it is reset to the present input, and may have to be manually reset. To manually reset the value, VAL must be in the lower display and then press the **ENTER** key. This will cause UAL to be reset to the present input value.

In the following the symbol "#" will be used following letters to refer to either a number "1" or number "2". The "1" will relate to SP1 functions, the "2" for SP2. If your control is not equipped with a second set point, no SP2 functions will appear. The appearance of CY#, SP#d, or PUL# is dependent upon the output type selected in the Secure Menu Item S#Ot. If time proportioning (cycle time) was selected, then CY# is adjustable. If On - Off was selected, then SP#d is adjustable. If pulsed time proportioning was selected then PUL# is adjustable. If none of the above are selected the menu indexes directly to S#Ot.

**CY#** Cycle Rate: Select **2** to **80** sec. Time Proportioning Control is adjustable in 2 sec. steps. For best contact life, a time should be selected as long as possible without causing the process to wander.

**SP#d** Set Point On-Off Differential. Select **1** to **1999** deg. or counts. When adjusting SP#d keep in mind that SPL and SPH have to be considered to avoid a CHEC error message.

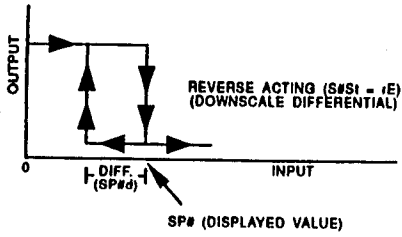
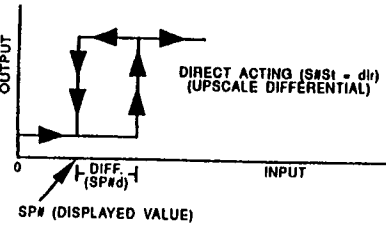



**PUL#** Pulsed Time Proportioning Output: Select 1 to 7. 1 = Linear and 7 = most non-linear. Changes output linearity for use in cooling applications or for an extremely fast response processes. At the center of the proportional band, a pulse value of 1 provides an output of one second on and one second off (50% output). A pulse value of 2 provides an output of one second on and two seconds off (33% output). Output at center of band equals one second on,  $2^{(\text{pulse value}-1)}$  seconds off.

**S#Ot** Set Point Output Type, FT, Curr, or Volt.

**Ft** refers to Fast Time Proportioning, for Solid State Relay or 5V Logic Outputs. Timing is fixed at 1 sec.

**Curr** refers to Proportional Current Output of 0 to 20 mA.

**Volt** refers to Proportional Voltage Output of 0 to 10 V.

Both Curr & Volt are selected by the Hardware Configuration Code and cannot be changed.

**PcIO** Percent Output Feature: Select On or OFF.

**On** When selected On, the HOME lower display will indicate the output of the controller in percent. An "o" will appear in the right hand side of the lower display to indicate percent output for SP1. An "s" will appear on the right hand corner of the lower display to represent percent output for SP2. The display will alternate between these values.

**OFF** Percent Output display is disabled.

**Prog** Ramp/Soak Feature: Select On or OFF

**StAt** Status Display in the HOME Position when Prog (above) is On: Select On or OFF. When selected OFF, the HOME display will alternately indicate the normal HOME and the Ramp/Soak partial status in the Lower Display. The partial status display sequences with the set value showing the ramp (S1rA) or soak (S1So) segment being processed at that moment. It will also show the Program output status if at Hold or OoFF.

When selected On, the HOME Display will alternately indicate the normal HOME and the Ramp/Soak full status in both the upper and lower displays. The full status display sequences with the set value; Program run, Hold, or OoFF; and with the time remaining for the ramp S1rA or the soak S1So segments.

**1rt** Ramp Time in Hours & Minutes: Select 0.00 to 99.59 (HH.MM).

**1St** Soak Time in Hours & Minutes: Select 0.00 to 99.59 (HH.MM).

**PEnd** End of Soak action: Select Hold or OoFF.

**Hold** Stay at the Present Set Pt.

**OoFF** Turn Off SP1 and SP2 Outputs at the End of the Soak.

**InPC** Input Correction: Select  $\pm 500$  °F ( $\pm 260$  °C) or  $\pm 1000$  counts. This feature allows the input value to be changed to agree with an external reference or to compensate for sensor error. When setting values having one or more decimal points, the lowest negative value allowed is -199.9, -19.99, or -1.999. **Note:** InPC is reset to zero when the input type is changed, or when decimal position is changed in T/C or RTD ranges. Changing decimal position in current or voltage ranges will not reset InPC.

**FILt** Digital Filter: Select OFF, 1 to 99. In some cases the time constant of the sensor, or noise could cause the display to jump enough to be unreadable. A setting of 2 is usually sufficient to provide enough filtering for most cases, (2 represents approximately a 1 second time constant). When the 0.1 degree resolution is selected this should be increased to 4. If this value is set too high, controllability will suffer.

**SECONDARY MENU (cont'd)**

**LPbr** Loop Break Protection: Select **OFF**, 1 to 9999 seconds. If, during operation, the output is minimum (0%) or maximum (100%), and the input moves less than 5°F (3°C) or 5 counts over the time set for LPbr, the **LOOP bAd** message will appear. This condition can also be routed to an Alarm Condition if alarms are present and turned On (see ALbr in the secure menu). The loop break error can be reset by pressing the **ENTER** key when at the LPbr menu item. The **INDEX & ENTER** keys may also be used.

*Process Output Low (936): Select -450°F, -260°C, or -1999 counts to 50 degrees or counts less than **POH**.*

*Process Output High (936): Select from 50 degrees or counts greater than **POL** to +9990°F, +5530°C, or 9990 counts. A voltage output is scalable from 0 to 10 VDC that represents the Process Variable. To properly scale the output, the values for **POL** and **POH** must be calculated. The simplest example is an output of 0 to 10 VDC from 0 to 200°. In this example **POL**=0 and **POH**=200. To Calculate **POL** and **POH** for other ranges use the following:*

$$K = \frac{\text{(Highest desired temperature - Lowest desired temperature)}}{\text{(Maximum desired voltage - Minimum desired voltage)}}$$

$$POH = \text{(10 - Maximum desired voltage)} * K + \text{Highest desired temperature}$$

$$POL = \text{(Minimum desired voltage - 0)} * K - \text{Lowest desired temperature}$$

**LOrE** Local / Remote Status (992): Select **LOC** or **rE**. When **LOC** is selected, the host computer is advised not to send remote commands. When **rE** is selected, **CFLt=2**, and **nAt** is set > 0, if the control is not accessed by the host computer in the time set in **nAt**, the control will revert to the **CFSP**.

**CFSP** Communications Fail Set Point (992): Set to desired value.

**Addr** Control Address (992): Set from 1 to FF. This number (hexadecimal, base 16) must match the address number used by the host computer. Viewed only in this menu.

## DIAGNOSTIC ERROR MESSAGES

DISPLAY	MEANING	SP1, SP2, and ALARM OUTPUTS	ACTION REQUIRED
UFL or OFL	Underflow or Overflow: Process value has exceeded input range ends set by SCAL or SCAH.	Set point outputs active Alarms active	Input signals may normally go above or below range ends. If not, check input and correct.
bAd InP  OPEn InP	UFL or OFL will sequence to display one of these messages if the InPt is set for a time value. For RTD, CURRENT, or VOLTAGE inputs; input error has occurred. For THERMOCOUPLE input the thermocouple is open.	Set point outputs inactive Alarms active	To reset, use the INDEX & ENTER keys. When InPt (input fault timer) has been set for a time, the outputs will be turned off after the set time. Setting the time to OFF causes the outputs to remain active; however, UFL or OFL will still be displayed. Correct or replace sensor. To reset use the INDEX & ENTER keys.
LOOP bAd	The sensor may be defective, heater fuse open, heater open or the final power output device is bad.	Set point outputs inactive Alarms active	Correct or replace sensor, or any element in the control loop that may have failed. To reset use the INDEX & ENTER keys, or press the ENTER key while in the LPBr menu item.
SEnC bAd	Sensor rate of change exceeded the programmed limits set for SENc.	Set point outputs inactive Alarms active	Check the cause. The value setting may be too slow for the process, or the sensor is intermittent. To reset use the INDEX & ENTER keys.
#### ArEA	Area appears if the controller's ambient temperature nears specification ends, -5°C (+23°F) or +50°C (+122°F).	Set point outputs active Alarms active	Correct the ambient temperature conditions. Ventilate the area of the cabinet or check for clogged air filters.
(blank) ArEA	Area appears if the controller's ambient temperature exceeds specification ends, -10°C (+14°F) or +55°C (+131°F).	Set point outputs inactive Alarms active	Correct the ambient temperature conditions. Ventilate the area of the cabinet or check for clogged air filters. To reset use the INDEX & ENTER keys.
CHEC CAL	Check calibration appears as an alternating message if the instrument calibration nears tolerance edges.	Set point outputs active Alarms active	Remove the instrument for service and / or recalibration. To reset use the INDEX & ENTER keys.
	Check calibration appears as a flashing message if the instrument calibration exceeds specification.	Set point outputs inactive Alarms active	

DISPLAY	MEANING	SP1, SP2 AND ALARM OUTPUTS	ACTION REQUIRED
No displays lighted	Both displays are blank. Instrument may not be getting power, or the supply voltage is too low.	Set points inactive Alarms inactive	Check that the power supply is on, or that the external fuses are good.
FAIL TEST	Fail test appears upon power up if the internal diagnostics detect a failure. This message may occur during operation if a failure is detected. Displays flash.	Set points inactive Alarms inactive	Press the INDEX key to display the following messages: <b>FACT dFLt</b> : Memory may be corrupted. Press the ENTER key and the DOWN ARROW key to start the factory default procedure. Re-check controller programming. <b>bAd A-d</b> : The A/D board is bad, return to factory. <b>rEt FACT</b> : Can not recover from error, return to factory for service.
CHEC SCAL or CHEC SCAH	The difference between scale low and scale high is programmed for more than 11,998 or less than 100 counts during programming of the voltage or current ranges.	Set points inactive Alarms inactive	Program parameter within the allowed count range.
CHEC SP1, CHEC #SP1, CHEC SP1d, CHEC SP2, CHEC SP2d, CHEC ALLo, CHEC ALHi, or CHEC CFSP	One or more of these messages will appear upon power up if any of these set points or differentials are set outside of the SPL or SPH values, or the range ends (SCAL or SCAH).	Set points inactive Alarms inactive	Check that each of the set points are within SPL, SPH range, or re-program SPL and / or SPH values to be at or beyond the set points values found in error. Do not exceed the range ends (SCAL or SCAH).
CHEC SPL or CHEC SPH	This message appears at power up if SPL or SPH values are programmed above or below the range ends (SCAL or SCAH). This message also appears if one or more set points are set above or below SPL or SPH during normal programming.	Set points inactive Alarms inactive	Correct the SPL or SPH values by programming new values. <b>CAUTION</b> : When the CHEC message appears, the value entered is rejected. The old value for that menu item is retained.
CHEC POL or CHEC POH	This message appears if the POL or POH values are incorrectly programmed.	Set points active Alarms active	Correct the POL or POH by programming new values.

# CONFIGURATION MENU



DO NOT ENTER THE CONFIGURATION MENU UNLESS YOU HAVE BEEN INSTRUCTED TO BY ANOTHER PART OF THESE INSTRUCTIONS. INCORRECT ENTRY OF DATA IN THE CONFIGURATION MENU MAY PREVENT YOUR CONTROL FROM OPERATING PROPERLY.

If re-configuration is required, follow the instructions below.

The Configuration Menu is used to quickly configure the instrument. The configuration for your particular model is shown on the Model / Serial label located on the top of the instrument housing. A label found inside on the right printed circuit board only shows the hardware configuration and options.

The numbers shown are defined as follows:

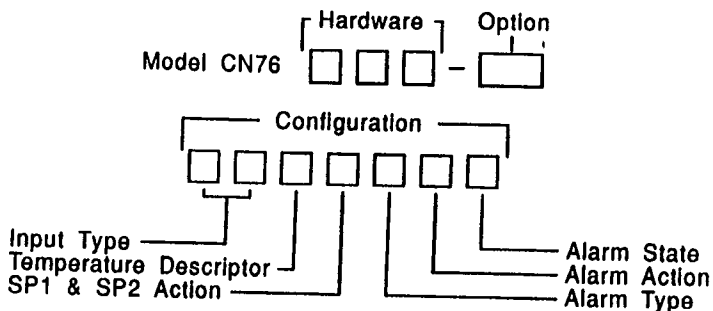

The Hardware configuration code **must not** be changed as it defines the hardware for the specific instrument. All other configuration may be altered if necessary. It is important that the codes be correctly entered in order for the instrument to function properly. If an invalid code number is entered for a particular configuration item, it will not be accepted and the old configuration code will be retained.

To re-configure:

1. At power up, simultaneously press and hold the **INDEX & ENTER** keys while the lamp test or self test is displayed. Hold the keys down until **Hrd1** appears. A dash appears in the upper display.
2. Press the **INDEX** key to advance through the menu items. Pressing the **INDEX & DOWN** keys simultaneously will back up to a menu item. Stop at the menu item you wish to change.
3. Press the **UP** or **DOWN** key to select the desired Configuration Code from the following chart.
4. Press **ENTER** to retain the Configuration Code.
5. Press **INDEX** to advance.
6. If you do not want to retain the re-configuration, this is your last chance to return to the old configuration. Press **ENTER** at **AcPt no** to exit and retain the old configuration.

# CONFIGURATION CHART

Do not change **Hrd1**, **Hrd2** or **Hrd3** to codes different from those on the controller labels. Codes in boldface type indicate factory defaults. See **FACT dFLT**.

DISPLAY	MENU ITEM	CONFIGURATION CODE		
Hrd1	Alarm Hardware	0 = NO	1 = YES	
Hrd2	Output A Hardware	1 = SSR/5 Vdc 2 = 5 Vdc/SSR	3 = RELAY/5 Vdc 4 = 5 Vdc/RELAY	5 = CURRENT 6 = VOLTAGE
Hrd3	Output B Hardware	0 = NONE 1 = SSR/5 Vdc	2 = 5 Vdc/SSR 3 = RELAY/5 Vdc	4 = 5 Vdc/RELAY
OPT1	Option Hardware	936 = Process Output                      948 = 4-Stage Set Point 992 = Serial Communications If number flashes, option is NOT selected. Press ENTER to select (number will not flash).		
CnF1	Input Type	01 = J 1° 02 = J 0.1° 03 = K 1° 04 = K 0.1° 05 = E 1° 06 = E 0.1° 07 = T 1° 08 = T 0.1° 09 = L 1° 10 = L 0.1°	11 = N 1° 12 = N 0.1° 13 = R 1° 14 = S 1° 15 = B 1° 16 = C 1° 17 = RTD 1° (DIN) 18 = RTD 0.1° (DIN) 19 = RTD 1° (NIST) 20 = RTD 0.1° (NIST)	21 = RTD 1° NI 22 = RTD 0.1° NI 23 = 0 to 20 mA 24 = 4 to 20 mA 25 = 0 to 5 Vdc 26 = 1 to 5 Vdc
CnF2	Temperature Descriptor	0 = No Descriptor 1 = °F	2 = °C	
CnF3	SP1 and SP2 Action	0 = SP1 = Output A, reverse action (Single Set Point Models) 1 = SP1 = Output A, direct action (Single Set Point Models) 2 = SP1 = Output A, reverse act.; SP2 = Output B, direct act. 3 = SP1 = Output B, reverse act.; SP2 = Output A, direct act. 4 = SP1 = Output A, direct act.; SP2 = Output B, reverse act. 5 = SP1 = Output B, direct act.; SP2 = Output A, reverse act. 6 = SP1 = Output A, reverse act.; SP2 = Output B, reverse act. 7 = SP1 = Output B, reverse act.; SP2 = Output A, reverse act. 8 = SP1 = Output A, direct act.; SP2 = Output B, direct act. 9 = SP1 = Output B, direct act.; SP2 = Output A, direct act.		
CnF4	Alarm Type	0 = No Alarm 1 = Absolute High Alarm 2 = Deviation High Alarm 3 = Absolute Low Alarm	4 = Deviation Low Alarm 5 = Absolute High - Low Alarms 6 = Deviation High - Low Alarms	
CnF5	Alarm Action	0 = No Alarm 1 = On - Off 2 = Manual Reset with Power Interrupt 3 = Manual Reset without Power Interrupt	4 = On - Off with Inhibit 5 = Manual Reset with Inhibit	
CnF6	Alarm State	0 = No Alarm 1 = Close at SP, LED flashing 2 = Open at SP, LED flashing	3 = Close at SP, LED off 4 = Open at SP, LED off	

## CONFIGURATION CHART (cont'd)

DISPLAY	MENU ITEM	CONFIGURATION CODE
CnF6	Alarm State	0 = No Alarm 1 = Close at SP, LED flashing 2 = Open at SP, LED flashing 3 = Close at SP, LED off 4 = Open at SP, LED off
AcPt	Accept Configuration	no = Retain old Configuration. Press ENTER to exit. YES = Accept Configuration. Press ENTER to exit.
Id ##		Factory Identification. Not for customer use.
FACT dFLt		Factory default. Defaults Configuration to factory codes shown in boldface type in the chart above.   <b>Warning:</b> The Hardware Configuration will be cleared and must be re-entered using the Hardware Configuration code found on the Model / Serial label located on the top of the instrument housing. The configuration menu cannot be exited until valid Hardware codes are entered.  If factory default is desired, simultaneously press the <b>ENTER &amp; DOWN ARROW</b> keys.

## SPECIFICATIONS

**Selectable Inputs:** Thermocouple, RTD, current or voltage.

**Input Impedance:**

Thermocouple = 3 megohms minimum.

RTD current = 200 uA.

Current = 249 ohms.

Voltage = 5000 ohms.

**Sensor Break Protection:** De-energizes control outputs to protect system.

**Loop Break Protection:** Error message is initiated upon shorted sensor or open heater circuit. Break time is adjustable from OFF to 9999 seconds.

**Loop Break Alarm:** If equipped with an Alarm relay, the Alarm may be programmed to operate upon a loop break.

**Set Point Range:** Selectable.

**Displays:** Two 4 digit, 7 segment 0.3" high LEDs. Process Variable red, Set Variable green.

**Control Action:** Reverse (usually heating), Direct (usually cooling) selectable for single or dual set point models.

**Proportional Band:** 6 to 5000 °F or equivalent °C for temperature inputs. 6 to 9990 counts for current or voltage inputs.

**Reset Time (Integral):** Off or 0.1 to 99.9 minutes.

**Rate Time (Derivative):** Off or 0.01 to 99.99 minutes.

**Cycle Rate:** 2 to 80 seconds,

**Approach Rate:** Off to 99.99 minutes.

**On - Off Differential:** Adjustable 2 °F to full scale in 1° steps (equivalent °C), or 2 counts to full scale in 1 count steps for current and voltage inputs.

**Alarm On - Off Differential:** 2 °F or equivalent in °C, or 2 counts.

**Scaling for Current or Voltage inputs:** Adjustable for a maximum negative to positive

span value of -1999 to +9999 counts (total span of 11,998 counts). Independent settings for low scale (SCAL) and high scale (SCAH) range ends.

**Ramp / Soak:** One ramp time and soak time, each adjustable from 0 to 100 hours. End procedure can be set for HOLD or OFF.

**Accuracy:**  $\pm 0.25\%$  of span,  $\pm 1$  least significant digit.

**Resolution:** 1 degree, 0.1 degree, or 1 count.

**Line Voltage Stability:**  $\pm 0.05\%$  over the supply voltage range.

**Temperature Stability:**  $4\mu\text{V}/^\circ\text{C}$  ( $2.3\mu\text{V}/^\circ\text{F}$ ) typical,  $8\mu\text{V}/^\circ\text{C}$  ( $4.5\mu\text{V}/^\circ\text{F}$ ) maximum.

**Common Mode Rejection:** 140 dB minimum at 60 Hz.

**Normal Mode Rejection:** 65 dB typical, 60 dB at 60 Hz.

**Isolation:** Relay and SSR outputs are isolated. Current, voltage, and 5 Vdc outputs must not share common grounds with the input.

**Power:** Vac: 100 to 240 Vac, nom.,  $+10\%$   $-15\%$ , 50 to 400 Hz, single phase  
Vdc: 132 to 240 Vdc, nom.,  $+10\%$   $-20\%$

**Power Consumption:** 3 VA nominal, 5VA maximum.

**Operating Temperature:**  $-10$  to  $+55\text{ }^\circ\text{C}$  ( $+14$  to  $131\text{ }^\circ\text{F}$ ).

**Storage Temperature:**  $-40$  to  $+80\text{ }^\circ\text{C}$  ( $-40$  to  $176\text{ }^\circ\text{F}$ ).

**Humidity Conditions:** 0 to 90% up to  $40\text{ }^\circ\text{C}$  non-condensing 10 to 50% at  $55\text{ }^\circ\text{C}$  non-condensing.

**Memory Backup:** Non-volatile memory. No batteries required.

**Control Output Ratings:**

1. SSR, 3.5 A @ 250 Vac at  $25\text{ }^\circ\text{C}$ . Derates to 1.25 A @  $55\text{ }^\circ\text{C}$ .
2. Mechanical Relay, Form A contact (SPST), 3 A @ 250 Vac resistive, 1.5 A @ 250 Vac inductive, Pilot duty rating = 250 VA, 2 A @ 125 Vac or 1 A @ 250 Vac. 1/8 HP @ 125 Vac or 250 Vac.
3. Alarm Relay, Form A contact (SPST). Same rating as control relay (2) above.
4. Current ( non-Isolated), 0 to 20 mA across 600 ohms maximum.
5. Voltage (non-Isolated), 0 to 10 Vdc across 500 ohms minimum.
6. 5 Vdc (non-Isolated), 5 Vdc @ 25 mA.

**Panel Cutout:** 45 mm x 45 mm ( $1.775\text{''}$  x  $1.775\text{''}$ ).

**Depth Behind Mounting Surface:** 115.3 mm ( $4.54\text{''}$ ).

**Weight:** 227 g (8 oz).

**Dimensions:** See diagram, Page 2.

**Agency Approvals:** UL and CSA pending.

**Front Panel Rating (non-hazardous locations):** Meets NEMA 2, 3R, and 12 ratings.



# Input Ranges

Input Type	RANGE	RESOLUTION	RANGE	RESOLUTION
J Iron-Constantan	-100 to 1600°F -100.0 to 990.0°F*	1°F 0.1°F	-73 to 871°C -73.0 to 871.0°C*	1°C 0.1°C
K CHROMEGA-ALOMEGA	-200 to 2500°F -190.0 to 990.0°F*	1°F 0.1°F	-129 to 1371°C -129.0 to 990.0°C*	1°C 0.1°C
E CHROMEGA-Constantan	-100 to 1800°F -100.0 to 990.0°F*	1°F 0.1°F	-73 to 982°C -73.0 to 982.0°C	1°C 0.1°C
T Copper-Constantan	-350 to 750°F -190.0 to 750.0°F*	1°F 0.1°F	-212 to 398°C -190.0 to 398.0°C*	1°C 0.1°C
N OMEGALLOY® Nicrosil-Nisil	-100 to 2372°F -100.0 to 990.0°F*	1°F 0.1°F	-73 to 1300°C -73.0 to 990.0°C*	1°C 0.1°C
R Pt 13% Rh-Pt	0 to 3200°F	1°F	-17 to 1760°C	1°C
S Pt 10% Rh-Pt	0 to 3200°F	1°F	-17 to 1760°C	1°C
B Pt 30% Rh-Pt 6% Rh	75 to 3308°F	1°F	-24 to 1820°C	1°C
C W 5% Re-W 26% Re	0 to 4208°F	1°F	-17 to 2320°C	1°C
RTD, 100 Ohm Platinum 0.00385 DIN curve	-328 to 1607°F -190.0 to 990.0°F*	1°F 0.1°F	-200 to 875°C -190.0 to 875.0°C*	1°C 0.1°C
RTD, 100 Ohm Platinum 0.00392 NIST curve	-328 to 1607°F -190.0 to 990.0°F*	1°F 0.1°F	-200 to 875°C -190.0 to 875.0°C*	1°C 0.1°C
RTD, 120 Ohm Nickel	-112 to 608°F -112.0 to 608.0°F	1°F 0.1°F	-80 to 320°C -80.0 to 320.0°C	1°C 0.1°C
Current: 0 to 20 mA, 4 to 20 mA	Programmable	Programmable	Programmable	Programmable
Voltage: 0 to 5 Vdc, 1 to 5Vdc	Programmable	Programmable	Programmable	Programmable

\* DISPLAY WILL REVERT TO 1° RANGE IF THE RANGE LIMITS FOR 0.1° RANGE ARE EXCEEDED.

## WARRANTY/DISCLAIMER

OMEGA ENGINEERING, INC. warrants this unit to be free of defects in materials and workmanship for a period of **13 months** from date of purchase. OMEGA's WARRANTY adds an additional one (1) month grace period to the normal **one (1) year product warranty** to cover handling and shipping time. This ensures that OMEGA's customers receive maximum coverage on each product.

If the unit malfunctions, it must be returned to the factory for evaluation. OMEGA's Customer Service Department will issue an Authorized Return (AR) number immediately upon phone or written request. Upon examination by OMEGA, if the unit is found to be defective, it will be repaired or replaced at no charge. OMEGA's WARRANTY does not apply to defects resulting from any action of the purchaser, including but not limited to mishandling, improper interfacing, operation outside of design limits, improper repair, or unauthorized modification. This WARRANTY is VOID if the unit shows evidence of having been tampered with or shows evidence of having been damaged as a result of excessive corrosion; or current, heat, moisture or vibration; improper specification; misapplication; misuse or other operating conditions outside of OMEGA's control. Components in which wear is not warranted, include but are not limited to contact points, fuses, and triacs.

**OMEGA is pleased to offer suggestions on the use of its various products. However, OMEGA neither assumes responsibility for any omissions or errors nor assumes liability for any damages that result from the use of its products in accordance with information provided by OMEGA, either verbal or written. OMEGA warrants only that the parts manufactured by the company will be as specified and free of defects. OMEGA MAKES NO OTHER WARRANTIES OR REPRESENTATIONS OF ANY KIND WHATSOEVER, EXPRESSED OR IMPLIED, EXCEPT THAT OF TITLE, AND ALL IMPLIED WARRANTIES INCLUDING ANY WARRANTY OF MERCHANTABILITY AND FITNESS FOR A PARTICULAR PURPOSE ARE HEREBY DISCLAIMED. LIMITATION OF LIABILITY: The remedies of purchaser set forth herein are exclusive, and the total liability of OMEGA with respect to this order, whether based on contract, warranty, negligence, indemnification, strict liability or otherwise, shall not exceed the purchase price of the component upon which liability is based. In no event shall OMEGA be liable for consequential, incidental or special damages.**

CONDITIONS: Equipment sold by OMEGA is not intended to be used, nor shall it be used: (1) as a "Basic Component" under 10 CFR 21 (NRC), used in or with any nuclear installation or activity; or (2) in medical applications or used on humans. Should any Product(s) be used in or with any nuclear installation or activity, medical application, used on humans, or misused in any way, OMEGA assumes no responsibility as set forth in our basic WARRANTY/DISCLAIMER language, and, additionally, purchaser will indemnify OMEGA and hold OMEGA harmless from any liability or damage whatsoever arising out of the use of the Product(s) in such a manner.

## RETURN REQUESTS/INQUIRIES

Direct all warranty and repair requests/inquiries to the OMEGA Customer Service Department. BEFORE RETURNING ANY PRODUCT(S) TO OMEGA, PURCHASER MUST OBTAIN AN AUTHORIZED RETURN (AR) NUMBER FROM OMEGA'S CUSTOMER SERVICE DEPARTMENT (IN ORDER TO AVOID PROCESSING DELAYS). The assigned AR number should then be marked on the outside of the return package and on any correspondence.

The purchaser is responsible for shipping charges, freight, insurance and proper packaging to prevent breakage in transit.

FOR **WARRANTY** RETURNS, please have the following information available BEFORE contacting OMEGA:

1. Purchase Order number under which the product was PURCHASED,
2. Model and serial number of the product under warranty, and
3. Repair instructions and/or specific problems relative to the product.

FOR **NON-WARRANTY** REPAIRS, consult OMEGA for current repair charges. Have the following information available BEFORE contacting OMEGA:

1. Purchase Order number to cover the COST of the repair,
2. Model and serial number of the product, and
3. Repair instructions and/or specific problems relative to the product.

OMEGA's policy is to make running changes, not model changes, whenever an improvement is possible. This affords our customers the latest in technology and engineering.

OMEGA is a registered trademark of OMEGA ENGINEERING, INC.

© Copyright 2017 OMEGA ENGINEERING, INC. All rights reserved. This document may not be copied, photocopied, reproduced, translated, or reduced to any electronic medium or machine-readable form, in whole or in part, without the prior written consent of OMEGA ENGINEERING, INC.

# Where Do I Find Everything I Need for Process Measurement and Control? **OMEGA...Of Course!** *Shop online at [omega.com](http://omega.com)*

## **TEMPERATURE**

- ☑ Thermocouple, RTD & Thermistor Probes, Connectors, Panels & Assemblies
- ☑ Wire: Thermocouple, RTD & Thermistor
- ☑ Calibrators & Ice Point References
- ☑ Recorders, Controllers & Process Monitors
- ☑ Infrared Pyrometers

## **PRESSURE, STRAIN AND FORCE**

- ☑ Transducers & Strain Gages
- ☑ Load Cells & Pressure Gages
- ☑ Displacement Transducers
- ☑ Instrumentation & Accessories

## **FLOW/LEVEL**

- ☑ Rotameters, Gas Mass Flowmeters & Flow Computers
- ☑ Air Velocity Indicators
- ☑ Turbine/Paddlewheel Systems
- ☑ Totalizers & Batch Controllers

## **pH/CONDUCTIVITY**

- ☑ pH Electrodes, Testers & Accessories
- ☑ Benchtop/Laboratory Meters
- ☑ Controllers, Calibrators, Simulators & Pumps
- ☑ Industrial pH & Conductivity Equipment

## **DATA ACQUISITION**

- ☑ Communications-Based Acquisition Systems
- ☑ Data Logging Systems
- ☑ Wireless Sensors, Transmitters, & Receivers
- ☑ Signal Conditioners
- ☑ Data Acquisition Software

## **HEATERS**

- ☑ Heating Cable
- ☑ Cartridge & Strip Heaters
- ☑ Immersion & Band Heaters
- ☑ Flexible Heaters
- ☑ Laboratory Heaters

## **ENVIRONMENTAL MONITORING AND CONTROL**

- ☑ Metering & Control Instrumentation
- ☑ Refractometers
- ☑ Pumps & Tubing
- ☑ Air, Soil & Water Monitors
- ☑ Industrial Water & Wastewater Treatment
- ☑ pH, Conductivity & Dissolved Oxygen Instruments