

CT63 NG Terminal User Manual

Revision 1.2



Important information

This technical description contains important information for start up and use of the CT63 NG Terminal. Read it carefully before you start working with the CT63 NG Terminal.

The warranty will be void should damage occur due to non-compliance with these instructions for use. We cannot accept any responsibility for consequential loss.

We cannot be held responsible for material loss or personal injury that is due to non-compliance with the safety instructions. The warranty will be void in such circumstances.

The CT63 NG Terminal contains highly integrated components which can be damaged by electrostatic discharge if the user would open the housing.

CEP preserves the right to change the included information without notice and doesn't take responsibility for errors in the document and/or missing information.

	Therefore only touch the CT63 NG Terminal on the housing or connectors and avoid touching the components on the board.
-----------------------------------------------------------------------------------	------------------------------------------------------------------------------------------------------------------------

Safety Instructions

Warning



When using products which are exposed to electric voltage the valid regulations have to be observed.

Before opening of a device always make sure that the device is disconnected from the power supply.

You should only use tools on components, modules or devices if they are disconnected from the power supply and the electric charge, which may still be stored in some components inside the device, has been discharged.

All cables and wires which are energized and connected to the device, the module or components have to be checked regularly for any damage of the isolation shield or fractures of the cables. If the supply cables are visibly damaged the device must be taken out of operation immediately until the faulty cable has been replaced.

When using components or modules, the specification given in the corresponding description of these components must strictly be observed. The device shall be operated only by appropriately qualified personnel.

This device shall only be used for its intended purpose.

Please note that we are not responsible for any errors in usage or wireless connection. Therefore we cannot accept any responsibility for consequential loss.

In case those measurements with the opened housing are necessary, an isolating-transformer has to be integrated for safety reasons. Alternatively the voltage can be supplied by an appropriate power supply which complies with the safety regulations. All wiring work has to be done in a voltage free state only.

Table of Contents

Important information.....	2
Safety Instructions	2
1 General Information	6
1.1 Contact for Support	6
1.2 Conventions Used in this Manual	6
1.3 Related Documentation	7
1.4 Abbreviations.....	7
1.5 Revision History.....	8
2 Product Description	9
2.1 Overview	9
2.2 Identification.....	10
2.3 Physical Dimensions and Weight	10
2.4 Product Features and Technical Data	11
2.5 CEP Certified Accessories	13
3 Safety and Product Care	14
3.1 Audience and Intended Use.....	14
3.2 Safety instructions	14
3.3 General precautions.....	14
3.4 SIM card precautions	15
3.5 Antenna precautions.....	15
4 Electrical Description	15
4.1 Power Connector	16
4.2 Antenna Connector.....	17
4.3 SIM card reader.....	17
4.4 RS232 Serial Port.....	18
4.4.1 Serial Data	19
4.5 Mini USB Connector.....	19
5 Operation	19
5.1 Switch ON the modem	19
5.2 Configuration of the bit rate on the serial interface.....	20
5.3 Power cycle the modem	20
5.4 Using low power mode of the modem	20

5.4.1	Low power mode with RTS/CTS/RING under DTE control	20
5.4.2	Low power mode with Looped RTS/CTS	21
5.5	Operating states / green LED	21
5.6	Controlling the Outputs	22
5.7	Power consumption during Regular Operation	22
6	Installation of the modem	23
6.1	Where to install the modem	23
6.1.1	Environmental conditions	23
6.1.2	GSM Signal strength	23
6.1.3	Connection of components to CT63 NG Terminal	23
6.1.4	Network and Subscription	23
6.2	How to install the modem	23
6.2.1	Power supply	23
6.2.2	Securing the modem	24
6.3	Antenna	24
6.3.1	General	24
6.3.2	Antenna type	24
6.3.3	Antenna placement	24
6.3.4	The antenna cable	25
6.3.5	Possible communications disturbances	25
7	Optional variants	26
7.1	CT63 NG with Mini USB with USB – Power (host powered)	26
7.2	RS485 Sub D9	26

Table Overview

Table 1: Abbreviation.....	7
Table 2: Documentation Change Log.....	8
Table 3: Feature Overview CT63 NG.....	12
Table 4: Accessories List.....	13
Table 5: RJ11 Pin and Signals Description.....	17
Table 6: Electrical characteristics of the serial port signals.....	18
Table 7: Power Consumption in Low Power Mode with RS232 under DTE control.....	21
Table 8: Power Consumption in Low Power Mode with Looped RTS/CTS.....	21
Table 9: Operating states of the green LED.....	21
Table 10: Power consumption in standby, idle and low power mode.....	22
Table 11: Mini USB with host powered Pin Signal.....	26

Figure Overview

Figure 1: Connector on rear side of the Terminal.....	9
Figure 2: Connectors on front side of the Terminal.....	9
Figure 3: Drawing of the Terminal's Housing.....	11
Figure 4: RJ11 Pin Connector.....	16
Figure 5: Looping RTS with CTS in the modem.....	18
Figure 6: Mini USB Type A/B connector.....	19
Figure 7: CT63 Mini USB with USB Power (host powered) Pin Connector.....	26
Figure 8: RS485 Sub-D 9-pin female connector with pin numbering.....	26

1 General Information

This User Manual consists of the following chapters:

Chapter	Description
1	General Information provides basic information such as the conventions for the warning levels, applicable related documentations, used abbreviations, a revision history and contact information.
2	Product Description provides a brief overview about the mechanical specification of the product (including size and weight) as well as an overview of the functions and features of the device as well as the available accessories.
3	Safety and Product Care addresses the audience for this manual, the intended use of this device and safety-related information important to read before using the device.
4	Electrical Description describes the electrical characteristics and pin allocation of the device's connectors.
5	Operation provides details relating to the commissioning of the device, including details on activating special features such as the low power mode.
6	Installation of the Modem provides important instructions about how to install the device for the M2M application.
7	Optional variants provides the electrical characteristics of optional product variants.

1.1 Contact for Support

Please submit your request to CEP customer support using the following online form:

<http://www.cepag.de/en/support/support-form>

Information about CEP AG, products and accessories, including FAQs, are available from the following web site: <http://www.cepag.de>.

1.2 Conventions Used in this Manual

The following conventions for warning levels are used in this manual:

Warning



Warnings against hazards that may result directly in **serious injuries or death** in case of non-observance.



Caution



Warnings against hazards that may result in **injuries** in case of non-observance.

NOTICE

Warnings against hazards that may result in **material damage** in case of non-observance.

	<p>Indicates that the device can be damaged by electrostatic discharge.</p>
	<p>This note contains helpful suggestions or references to material not covered in the document.</p>

1.3 Related Documentation

Please consult the download zone of the CEP AG website for additional documents related to CT63 NG, such as AT command manuals. Note that such type of documents can be accessed online only after you have registered on our website and agreed with our terms of use. Please follow this link to register for a user account:

<http://www.cepag.de/en/en-nda-reg-form>

...or use the following link to login if you already have a valid user account:

<http://www.cepag.de/en/en-user-login>

1.4 Abbreviations

Abbreviation	Explanations
CSD	Circuit Switched Data
DCE	Data Circuit Terminating Equipment
DTE	Data Terminal Equipment
GPRS	General Packet Radio Service
GSM	Global System for Mobile Communication
MS	Mobile Station
MT	Mobile Terminated
PDU	Protocol Data Unit
SIM	Subscriber Identity Module
SMS	Short Message Service
URC	Unsolicited Result Code
VIH	Volt Input high
VIL	Volt Input low
VSWR	Voltage Standing Wave Ratio

Table 1: Abbreviation

1.5 Revision History

Revision	Date	Changes
Rev 1.0	14.10.2015	First version of the document.
Rev 1.1	06.11.2015	Corrected Section 1.3. Updated product naming.
Rev 1.2	09.12.2015	Updated Sections 4.4 (RS232 Serial Port) and 5.4 (Using low power mode of the modem). Added new Section 5.2 (Configuration of the bit rate on the serial interface)

Table 2: Documentation Change Log

2 Product Description

2.1 Overview

The pictures below show the mechanical design of the CT63 NG Terminal along with the positions of the different connectors and mounting holes. The CT63 NG Terminal case is made of durable PC/ABS plastic.



Figure 1: Connector on rear side of the Terminal



Figure 2: Connectors on front side of the Terminal

Please note the following:



- The terminal can be securely fitted into your application by using the mounting holes positioned at the two of the corners of the device make it possible to securely bolt the modem into your application.
- The SIM card is mounted in the modem, and is accessible by to the user under a lid without the need to use any tools.
- Section 4 Electrical Description“2. Electrical Description” describes the pins and electrical characteristics or of the modem’s terminal’s various connectors are described in
- Section 4.2 Antenna Connector“2.3 Antenna Connector” provides information about the antenna connector is found in “2.3 Antenna Connector”

	<p>A special DIN Rail Mounting Bracket can be offered as an accessory item (Art-Nr. 12304) which allows installation of the modem in industrial environments using DIN Rails.</p>
-----------------------------------------------------------------------------------	-----------------------------------------------------------------------------------------------------------------------------------------------------------------------------------

2.2 Identification

On the bottom of the device, you will find the type label.



Label	Description
S/N	Serial number ¹
	Serial number
IMEI	International Mobile Equipment Identity
FW	GSM firmware version
HW-Rev.	Hardware Revision Number + Production date
	CE conformity mark
	Disposal in accordance with European Directive 2002/96/CE

2.3 Physical Dimensions and Weight

Overall dimensions: 77 x 67 x 26 mm

Weight: approx. 80g

¹ Note that the serial number consists of a 4-digit product ID followed by the device’s IMEI.

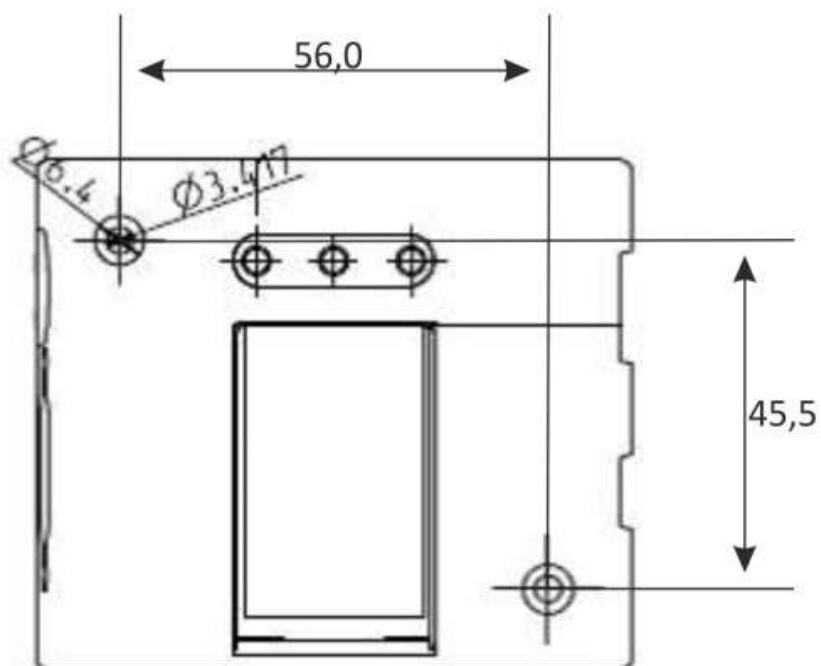

Figure 3: Drawing of the Terminal's Housing

2.4 Product Features and Technical Data

NOTICE

CEP AG may, at any time and without notice, make changes or improvements to the products and services offered and / or cease producing or commercializing them.

Category	Features	Details
Air Interface	2G Frequency Band	850 / 900 / 1800 / 1900 MHz
	GPRS Class	Class 12
	GPRS Features	Full PBCCH support Mobile Station Class B Coding Scheme 1 – 4
	Output Power	Class 4 (2W) for GSM850/GSM900 Class 1 (1W) for GSM1800/GSM1900
	CSD	Up to 9.6 kbps, V.110, RLP, non-transparent USSD
	SMS	Point-to-point MT and MO Text and PDU mode, Cell Broadcast
	Jamming Detection	
Hardware Features	Memory	5 MB RAM / 10 MB Flash
	SIM Card Holder	1x (1,8/3 Volt)
	LEDs	1 GSM + 2 Configurable
	Real-time Clock	RTC with alarm functionality
	Type Approvals	CE
Connectors	D-Sub (9-pin)	1x Female (RS232)

Category	Features	Details
	USB	1x Mini-USB (USB 2.0)
	RJ11	1x Power + IOs (1x Analogue Input; 1x Output)
Interfaces / Connectors	Antenna	1x (FME Male)
	RS232	1x (Sub-D9 Female)
	RS485 (optional)	1x (Sub-D9 Female)
	USB 2.0	1x (Mini-USB)
	Analog Inputs	1x (RJ11 connector)
	Outputs	1x (RJ11 connector)
Software	AT Command Set	Gemalto standardized and extended AT commands (Hayes, TS 27.007 and 27.005)
	Programming Language	Java profile IMP-NG & CLDC 1.1 HI
	SIM Application Toolkit	SAT Release 99
	TCP/IP Stack	Access via AT commands and transparent TCP services
	SW Update	Serial / USB / FOTA
Power Management	Voltage Range	5V - 32V
Hardware Characteristics	Operating Temperature	-40°C to +80°C
	Dimensions	77x66x26 mm
	Weight	80g

Table 3: Feature Overview CT63 NG

2.5 CEP Certified Accessories

Art-Nr.	Description
12002	Power supply 230V AC / 12 V DC with 6-pin RJ11 connector
12003	Power cable with 6pin RJ11 connector and with open ends
12021	FME female Magnetic Antenna / Pentaband (Quad&UMTS)
12016	FME female Rectangular Antenna / Pentaband (Quad&UMTS)
12020	FME female Patch Antenna/ Pentaband (Quad&UMTS)
12006	Roof-mount antenna, FME female waterproof, 900/1800 MHz
12004	RS232 cable, 1.5m for PC connection
12304	DIN Rail Mounting Bracket

Table 4: Accessories List

Please contact your distributor or CEP AG for availability or check CEP's webpage www.cepag.de.

3 Safety and Product Care

This device has been designed in accordance with state-of-the-art standards, manufactured with utmost care using high-quality materials, and tested. Nevertheless, its use may constitute a risk to persons or cause material damage.

The following safety instructions must be followed in order to ensure the safety of users and the device.

NOTICE

If these instructions are ignored, CEP AG will not assume responsibility for any damages that are incurred. CEP AG may refuse warranty claims where evidence of product misuse is found.

Please read the information in this section and the information in Section 6 Installation of the modem before starting your integration work!

3.1 Audience and Intended Use

This terminal product is targeted towards system integrators who need to add a wireless communications link to their M2M application, in order to capture data from the application as well as to remotely control that application. Any other use is not intended.

3.2 Safety instructions

PLEASE READ THESE SAFETY INSTRUCTIONS AND KEEP A COPY OF THEM.

- Always ensure that use of the modem is permitted. The modem may present a hazard if used in proximity to of personal medical electronic devices. As a rule, the modem must not be used in hospitals, airports or planes.
- Never use the modem at a gas station, refueling point, blasting area or in any other environment where explosives may be present.
- Operating the modem close to other electronic devices, such as antennas, television sets, and radios may cause electromagnetic interference.
- This product is intended to be used with the antenna or other radiating element at least 20 cm away from any part of the human body. In applications where this rule cannot be applied, the application designer is responsible for providing the SAR measurement test report and declaration.
- You are responsible for observing your country's safety standards, and where applicable, the relevant wiring rules.

3.3 General precautions

The CT63 NG Terminal as a stand-alone item is designed for indoor use only. To use outside it must be integrated into a weatherproof enclosure. Do not exceed the environmental and electrical limits as specified in Section 2.4 Product Features and Technical Data.

- Avoid exposing the modem to lighted cigarettes, naked flames or to extreme hot or cold temperatures.
- Never try to dismantle the modem yourself. There are no components inside the modem that can be serviced by the user. If you attempt to dismantle the modem, you may invalidate the warranty.
- The CT63 NG Terminal must not be installed or located where the surface temperature of the plastic case may exceed 85°C.

- All cables connected to the CT63 NG Terminal must be secured or clamped, immediately adjacent to the modem's connectors, to provide strain relief and to avoid transmitting excessive vibration to the modem in the installation.
- Ensure the cables, supplying power, audio headset, and input cable to the CT63 NG Terminal, does do not exceed 3meters.
- To protect power supply cables and meet the fire safety requirements when the unit is powered from a battery or a high current supply, connect a fast 1.25A fuse in line with the positive supply.
- Do not connect any incompatible component or product to the CT63 NG Terminal.

3.4 SIM card precautions

Before handling the SIM card in your application, ensure that you are not charged with static electricity. Use proper precautions to avoid electrostatic discharges.

When the SIM card hatch is opened, the SIM card connectors lie exposed under the SIM card holder.

Caution! Do not touch these connectors! If you do, you may release an electrical discharge that could damage the modem or the SIM card.

When designing your application, the SIM card's accessibility should be taken into account. We always recommend that you have the SIM card protected by a PIN code. This will ensure that the SIM card cannot be used by an unauthorized person.

3.5 Antenna precautions

If the antenna is to be mounted outside, consider the risk of lightning. Follow the instructions provided by the antenna manufacturer.

- Never connect more than one modem to a single antenna. The modem can be damaged by radio frequency energy from the transmitter of another modem.
- Like any mobile station, the antenna of the modem emits radio frequency energy. To avoid EMI (electromagnetic interference), you must determine whether the application itself, or equipment in the application's proximity, needs further protection against radio emission and the disturbances it might cause. Protection is secured either by shielding the surrounding electronics or by moving the antenna away from the electronics and the external signals cable.
- The modem and antenna may be damaged if either come into contact with ground potentials other than the one in your application. Beware, ground potential are not always what they appear to be.

4 Electrical Description

The modem uses the following standard connectors:

- [RJ11 6-way \(power + 1 analogue input + 1 output\)](#)
- [Mini USB \(USB 2.0\)](#)
- [SIM card reader](#)
- [FME male coaxial jack \(antenna connector\)](#)
- [Sub-D female socket, 9 pin \(RS232 serial port\)](#)

4.1 Power Connector

An RJ11 6-way connector, as shown and described below, serves as a means of supplying and controlling DC power to the modem. The use of an external power supply is necessary as the USB port is not intended to be used as power source.²

The supply voltage VCC required by the modem is 5V - 32V DC. Please note that applying the supply voltage does not switch the modem on. To do so an additional active-high control signal, TO_IN, must be applied for > 1 second.

Please see chapter 5.1 Switch ON the modem for further important details about TO_IN and power supply requirements, especially if TO_IN is applied in parallel to VCC.

	<p>VCC and GND are reverse-polarity and over-voltage protected as long as antenna interface and the user's application are unused or connected to separate grounds.</p>
-----------------------------------------------------------------------------------	-------------------------------------------------------------------------------------------------------------------------------------------------------------------------

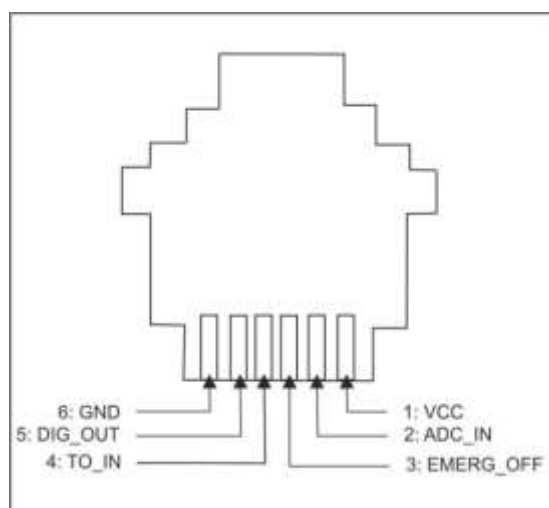



Figure 4: RJ11 Pin Connector

PIN	Signal	Direction	Limits	Description
1	VCC	Input	5 – 32V	Positive power input, DC
2	ADC_IN	Input	0-32V	Analogue Input
3	EMERG_OFF	Input	5 – 32V	Active high control line used to switch off the terminal $V_{IH} > 5V$, $V_{IL} < .5V$ Power off: $t > 1s$
4	TO_IN	Input	5 – 32V	Positive edge triggered signal; used to switch on the modem $V_{IH} > 5V$, $V_{IL} < 0.5V$ Power on: $t > 1s$ after VCC available V_{IH} = Volt Input high V_{IL} = Volt Input low

² This Statement does not apply to the USB Host Powered version of the CT63 NG.

PIN	Signal	Direction	Limits	Description
5	DIG_OUT	Output	5 - VCC	Digital Output VCC, max. 400 mA
6	GND	Input	-	Negative power (ground) input and return path for TO_IN and EMERG_OFF

Table 5: RJ11 Pin and Signals Description

	<p>The TO_IN signal requires a positive “edge” (a sharp” signal transition from low to high) to turn the modem on. This transition should be a rising signal from 0V (GND) to VCC, or at least a large fraction of that voltage range, and must be applied at the same time as VCC or after it. Very slow transitions (significantly slower than many milliseconds) or very small transitions (e.g. only few volts instead of 0V to VCC) will not turn on the module (since they are not considered to be a “positive edge”).</p>
-----------------------------------------------------------------------------------	-----------------------------------------------------------------------------------------------------------------------------------------------------------------------------------------------------------------------------------------------------------------------------------------------------------------------------------------------------------------------------------------------------------------------------------------------------------------------------------------------------------------------------------

4.2 Antenna Connector

The antenna connector allows transmission of radio frequency (RF) signals between the modem and an external customer-supplied antenna. The modem is assembled with a 50 Ohms, FME male coaxial jack.

The customer-selected antenna should fulfil the following requirements:

- Frequency range: Quadband (GSM 850/ 900/ 1800/ 1900 MHz)
- Bandwidth: 80 MHz in EGSM 90
- Gain: <3dBi
- Impedance: 50 Ohms
- Input Power: >33 dBm (2W) peak power in GSM
- VSWR recommended: <2

4.3 SIM card reader

The CT63 NG Terminal is fitted with a SIM card reader designed for 1.8V and for 3V SIM cards. It is the flip-up type which is lockable in the horizontal position and is accessed through a removable panel.

4.4 RS232 Serial Port

The modem supports a standard RS232 serial interface via its 9 pin Sub-D connector, shown below. In line with serial communication terminology the CT63 NG Terminal should be considered as the data circuit-terminating equipment (DCE) and the external application or computer as the data terminating equipment (DTE). The maximum baud rate to communicate with the CT63 NG Terminal is 230400 kbit/s.

Some functions need to be configured or activated using module specific AT commands. Please refer to the appropriate AT command manual referenced in Section xyz for further details.

NOTICE

The RS232 interface requires full RTS / CTS Flow Control support by the remote station connecting to the terminal. If you just have Rx/Tx/GND connected in the serial interface, you have to connect the RTS with the CTS pin in order to be able to communicate with the module (Pins 7 and 8 on the DCE, i.e. modem; see picture below).

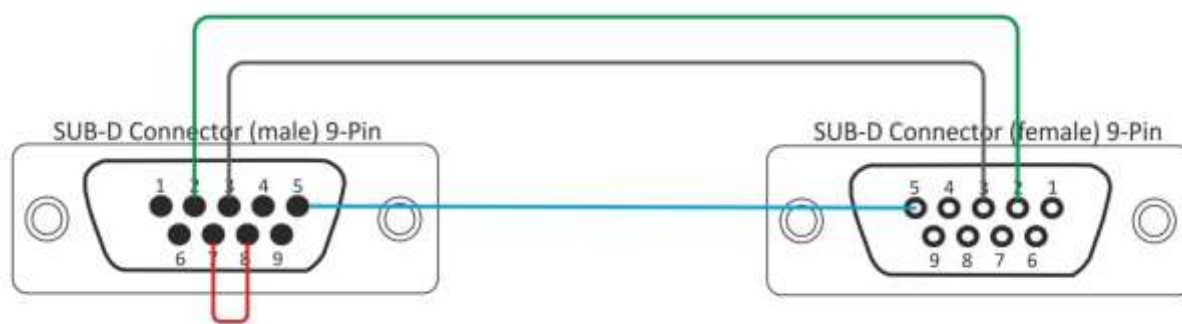

Figure 5: Looping RTS with CTS in the modem

PIN	Signal	Direction	Limits	Description
1	DCD	Output	> + 4V <- 4 V	Data carrier detect
2	RD	Output	> + 4V <- 4 V	Received data
3	TD	Input	> + 2,4V < 0.8 V	Transmitted data
4	DTR	Input	> + 4V < 0.8 V	Data terminal ready
5	GND	-	0 V	Ground connection
6	DSR	Output	> + 4V <- 4 V	Data set ready
7	RTS	Input	> + 2,4V < 0.8 V	Request to send
8	CTS	Output	> + 4V <- 4 V	Clear to send
9	RI	Output	> + 4V <- 4 V	Ring indicator

Table 6: Electrical characteristics of the serial port signals

4.4.1 Serial Data

The modem supports the standard data character format of

- Programmable baud rate (300bps to 230,400bps).
- Auto-configuration mode with auto-baud (1,200bps to 230,400bps).
- Multiplex ability according to GSM 07.10 Multiplexer Protocol.

4.5 Mini USB Connector

The modem supports a standard USB 2.0 Full Speed slave interface to receive AT-commands as well as data transmissions.

Drivers for several operating systems (e.g. Windows Vista, Windows XP or Linux) are available for download from the CEP AG website (for registered users only).

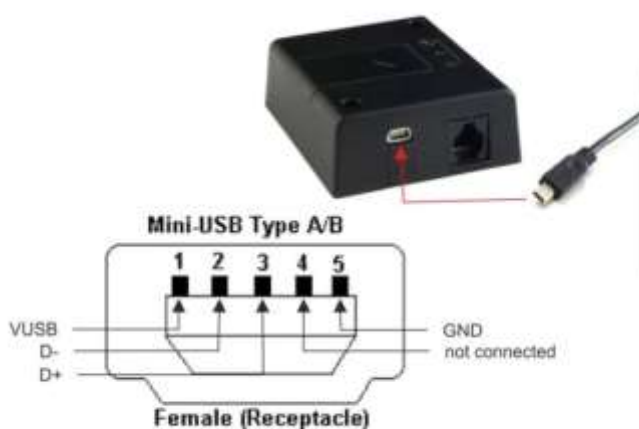

Figure 6: Mini USB Type A/B connector

5 Operation

5.1 Switch ON the modem

There are two ways to switch on the modem, once power is applied:

- assert TO_IN to high level for > 1s
- activate the RS232 control line DTR for >0.2s

The modem is fully operational after 4 seconds. Logging onto a network may take longer than this and is outside the control of the modem. The modem can be configured to start up at the time power is applied by permanently tying power connector signals TO_IN (pin 4) and VCC (pin 1) together.

	DTR must be cycled from low to high.
-------------------------------------------------------------------------------------	--------------------------------------

Although this will not be an issue in almost all typical applications of the modem, there are a few cases in which the modem might not recognize the power up signal. This is no failure of the modem itself, the same would apply to almost any electronic device that provides a separate “power on” or “reset” signal.

Possible cases are the following:

- Older power supplies often have large capacitors which lead to slow leading and falling edges (tying TO_IN in parallel to VCC instead of using a separate dedicated digital signal might increase this effect)
- Slow analogue signals used to assert TO_IN

If you are in doubt, please

- Use the mains power adapter that is provided by your distributor and is known to work properly with your modem.
- Make sure that your signal and system design is according to the above.
- Consult our support team that will be more than happy to assist you.

5.2 Configuration of the bit rate on the serial interface

Please note that autobauding is activated by default upon delivery (using the AT command "AT+IPR=0", please refer to Section 4.6 "AT+IPR Bit Rate" of the BGS5 AT Command Guide for further details).

5.3 Power cycle the modem

There are two ways to switch off (power down) the modem as described below:

- EMERG_OFF to high level for $t > 1s$

Turn off, or disconnect the power supply.

5.4 Using low power mode of the modem

Below are some short descriptions on how to enter and exit the low power state of the modem.

NOTICE

Please note that the power consumption in low power mode is different according to the used method!

5.4.1 Low power mode with RTS/CTS/RING under DTE control

Enabling the low power mode:

- Wait until the GSM module is logged into the GSM network
- Send the AT command "AT^SPOW=2,2000,3" (activating the serial interface for 2000 ms = 2 s to receive the wake-up AT command)
- Set the RTS control line on DTE side from High level to Low level
- A stable low-power mode should be achieved after approx. 1-2 minutes.

Disabling the low power mode by user:

- Set the RTS control line on DTE side from Low level to High level
- The RS-232 transceiver is activated immediately for the time-period which had been previously configured when enabling the low power mode, i.e. for a duration of 2 seconds
- Within these 2 seconds the following command must be sent to disable the low power mode: "AT^SPOW=1,0,0"

Disabling the low power mode upon receiving GSM activity

- Call the number of the SIM card inserted in the modem, or send an SMS message
- The RING line will change from Low to High level
- Set the RTS Line on the DTE side from Low to High level

- URC “Ring” will appear
- Send the AT command “AT^SPOW=1,0,0”

Power consumption table

	[mA] @ 5V	[mA] @ 12V	[mA] @ 24V	[mA] @ 32V
Low power mode	2,1	1,5	1,6	1,7

Table 7: Power Consumption in Low Power Mode with RS232 under DTE control

5.4.2 Low power mode with Looped RTS/CTS

Enabling the low power mode:

- Wait until the GSM module is logged into the GSM network
- Send the AT command "AT^SPOW=2,2000,3" (activating the serial interface for 2000 ms = 2 s to receive the wake-up AT command)
- A stable low-power mode should be achieved after approx. 1-2 minutes.

Disabling the low power mode by user:

- A deactivation is possible while the serial interface is active (the duration of this active state was configured during the activation of the low power mode, i.e. in this case 3 ms).
- While in active state, send the following command to disable the low power mode: “AT^SPOW=1,0,0”

Disabling the low power mode upon receiving GSM activity

- Call the number of the SIM card inserted in the modem, or send an SMS message
- URC “Ring” will appear
- Send the AT command “AT^SPOW=1,0,0”

Power consumption table

	[mA] @ 5V	[mA] @ 12V	[mA] @ 24V	[mA] @ 32V
Low power mode	14,2	6,8	5,8	4,8

Table 8: Power Consumption in Low Power Mode with Looped RTS/CTS

5.5 Operating states / green LED

The modem has a green power up LED, as depicted below, which is used to indicate various operating states. These states are described in following table.

SLED = 2,50 Operating state of CT63 Terminal	green LED state
Device off	Permanently off
net search / not registered /	Fast blinking (500ms on/500ms off)
registered full service	Slow blinking (500ms on/3990ms off)
A call is active	Fast blinking (50ms on/990ms off)

Table 9: Operating states of the green LED

5.6 Controlling the Outputs

The following table shows you the AT commands to control or read out the inputs and outputs:

Output / function	Command
DIG_OUT configuration	AT^SCPIN=1,3,1,0
DIG_OUT High (VCC voltage)	AT^SSIO=3,1
DIG_OUT Low (ca. 1.6 Volts)	AT^SSIO=3,0
Yellow LED configuration	AT^SCPIN=1,5,1,0
Yellow LED on	AT^SSIO=5,1
Yellow LED off	AT^SSIO=5,0
Red LED configuration	AT^SCPIN=1,6,1,0
Red LED on	AT^SSIO=6,1
Red LED off	AT^SSIO=6,0
ANALOG-IN read out value	AT^SRADC=1

The ANALOG-IN-value needs to be calculated using the return value of the read out command. Therefore use the following formula:

$$V_{\text{ANALOG-IN}} = (\text{return_value} / 6.8) \times 204.8 \text{ (Result is in mill volts)}$$

5.7 Power consumption during Regular Operation

The following table shows you the power consumption of the CT63 NG Terminal in different modes.

Please refer to Table 7 and Table 8 for details of power consumption in Low Power Mode.

	[mA] @ 5V	[mA] @ 12V	[mA] @ 24V	[mA] @ 32V
Modem is off (DTR low, no TO-IN)	0,01	0,14	0,26	0,35
CT63 idle mode (Modem is on, logged into GSM network, serial interface is disconnected)	22,2	10,4	8,8	6,7

Table 10: Power consumption in standby, idle and low power mode

6 Installation of the modem

This chapter gives you advice and helpful hints on how to integrate the CT63 NG Terminal into your application from a hardware perspective. Please read the information given in Section 2 Product Description and then read the information in this section before starting your integration work.

6.1 Where to install the modem

There are several conditions which need to be taken into consideration when designing your application as they might affect the modem and its function. They are:

6.1.1 Environmental conditions

The modem must be installed so that the environmental conditions stated in Section 2.4 Product Features and Technical Data, such as temperature, humidity and vibration are satisfied. Additionally, the electrical specifications in Section 2.4 Product Features and Technical Data must not be exceeded.

6.1.2 GSM Signal strength

The modem has to be placed in a way that ensures sufficient GSM signal strength. To improve signal strength, the antenna can be moved to another position. Signal strength may depend on how close the modem is to a radio base station. You must ensure that the location at which you intend to use the modem is within the network coverage area. Degradation in signal strength can be the result of a disturbance from another source, for example an electronic device in the immediate vicinity. More information about possible communication disturbances can be found in section 5.3.5.

When an application is completed, you can verify signal strength by issuing the AT command AT+CSQ. See "AT + CSQ Signal Strength".

Tip! Before installing the modem, use an ordinary mobile telephone to check a possible location for it. In determining the location for the modem and antenna, you should consider signal strength as well as cable length

6.1.3 Connection of components to CT63 NG Terminal

The integrator is responsible for the final integrated system. Incorrectly designed or installed external components may cause radiation limits to be exceeded. For instance, improperly made connections or improperly installed antennas can disturb the network and lead to malfunctions in the modem or equipment.

6.1.4 Network and Subscription

Before your application is used, you must ensure that your chosen network provides the necessary telecommunication services. Contact your service provider to obtain the necessary information.

- If you intend to use SMS in the application, ensure this is included in your (voice) subscription.
- Consider the choice of the supplementary services

6.2 How to install the modem

6.2.1 Power supply

- Use a high-quality power supply cable with low resistance. This ensures that the voltages at the connector pins are within the allowed range, even during the maximum peak current.
- When the unit is powered from a battery or a high current supply, connect a fast 1.25A fuse in line with the positive supply. This protects the power cabling and modem.

6.2.2 Securing the modem

Before securing the modem take into account the amount of additional space required for the mating connectors and cables that will be used in the application.

- Where access is restricted, it may be easier to connect all the cables to the modem prior to securing it in the application.
- Securely attach the CT63 NG Terminal modem to the host application using two 3mm diameter pan-head screws.

6.3 Antenna

6.3.1 General

The antenna is the component in your system that maintains the radio link between the network and the modem. Since the antenna transmits and receives electromagnetic energy, its efficient function will depend on:

- the type of antenna (for example, circular or directional);
- the placement of the antenna;
- Communication disturbances in the vicinity of the antenna.

The following sections address issues concerning antenna type, antenna placement, antenna cable, and possible communication disturbances. In any event, you should contact your antenna manufacturer for additional information concerning antenna type, cables, connectors, antenna placement, and the surrounding area. You should also determine whether the antenna needs to be grounded or not. Your antenna manufacturer might be able to design a special antenna suitable for the application.

6.3.2 Antenna type

Make sure that you choose the right type of antenna for the modem. Consider the following requirements:

- The antenna must be designed for the one of the frequency bands in use; please ask your network provider for more information:
 - GSM 850/900 MHz
 - GSM 1800/1900 MHz;
- The impedance of the antenna and antenna cable must be 50Ω;
- The antenna output-power handling must be a minimum of 2W;
- The VSWR value should be less than 3:1 to avoid any damage to the modem.

6.3.3 Antenna placement

The antenna should be placed away from electronic devices or other antennas. The recommended minimum distance between adjacent antennas, operating in a similar radio frequency band, is at least 50cm. Therefore we recommend using a cable antenna and placing it away from the terminal. If signal strength is weak, it is useful to face a directional antenna at the closest radio base station. This can increase the strength of the signal received by the modem. The modem's peak output power can reach 2W. RF field strength varies with antenna type and distance. At 10cm from the antenna the field strength may be up to 70V/m and at 1m it will have reduced to 7V/m. In general, CE-marked products for residential and commercial areas, and light industry can withstand a minimum of 3V/m.

6.3.4 The antenna cable

Use 50 Ω impedance low-loss cable and high-quality 50 Ω impedance connectors (frequency range up to 2GHz) to avoid RF losses. Ensure that the antenna cable is as short as possible. The Voltage Standing-Wave Ratio (VSWR) may depend on the effectiveness of the antenna, cable and connectors. In addition, if you use an adapter between the antenna cable and the antenna connector, it is crucial that the antenna cable is a high-quality, low-loss cable. Minimize the use of extension cables, connectors and adapters. Each additional cable, connector or adapter causes a loss of signal power.

6.3.5 Possible communications disturbances

Possible communication disturbances include the following:

- **Noise** can be caused by electronic devices and radio transmitters.
- **Path-loss** occurs as the strength of the received signal steadily decreases in proportion to the distance from the transmitter.
- **Shadowing** is a form of environmental attenuation of radio signals caused by hills, buildings, trees or even vehicles. This can be a particular problem inside buildings, especially if the walls are thick and reinforced.
- **Multi-path fading** is a sudden decrease or increase in the signal strength. This is the result of interference caused when direct and reflected signals reach the antenna simultaneously. Surfaces such as buildings, streets, vehicles, etc., can reflect signals.
- **Hand-over** occurs as you move from one cell to another in the GSM network. Your mobile application call is transferred from one cell to the next. Hand-over can briefly interfere with communication and may cause a delay, or at worst, a disruption.

7 Optional variants

Optional variants are available, please find below the technical information for:

- USB Powered version (host powered)
- RS485

Please contact your distributor or CEP AG directly for further information if necessary.

7.1 CT63 NG with Mini USB with USB – Power (host powered)

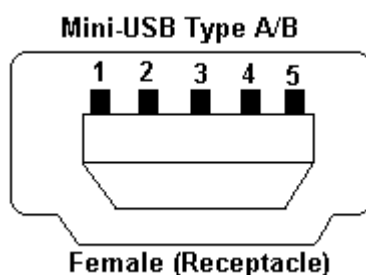

Figure 7: CT63 Mini USB with USB Power (host powered) Pin Connector

Pin	Signal
1	VUSB (5V DC)
2	D-
3	D+
4	not connected
5	GND

Table 11: Mini USB with host powered Pin Signal

7.2 RS485 Sub D9

The modem supports a standard RS485 serial interface via its 9-pin Sub-D connector, shown below.

- Autobauding supported at start up
- Internal termination of the RS485-interface is 120 Ohms.

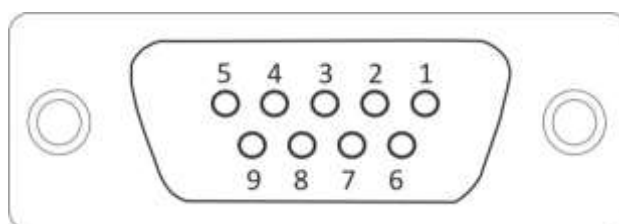

Figure 8: RS485 Sub-D 9-pin female connector with pin numbering

PIN	Signal	Direction	Limits	Description
1	nc	-	-	Not connected
2	B	Differential	5V	RS485-B
3	G	-	-	Optional shielding
4	A	Differential	5V	RS485-A
5	GND	-	0V	Ground connection
6	nc	-	-	Not connected
7	nc	-	-	Not connected
8	nc	-	-	Not connected
9	nc	-	-	Not connected

Table 10: Electrical characteristics of the RS485-serial port signals