



DDW-142 and DDW-242

Industrial Ethernet Extender



Table of Contents

1. General Information	3
1.1. Legal Information	3
1.2. About This Guide	3
1.3. Software Tools	3
1.4. License and Copyright for Included FLOSS	3
1.5. WeOS Management Guide	3
2. Safety and Regulations	4
2.1. Warning Levels	4
2.2. Safety Information	5
2.3. Care Recommendations	6
2.4. Product Disposal	7
2.5. Compliance Information	7
2.5.1. Agency Approvals and Standards Compliance	7
2.5.2. FCC Part 15.105 Class B Notice	7
2.5.3. Corrosive Environment	8
2.5.4. Simplified Declaration of Conformity	8
3. Product Description	9
3.1. Product Description	9
3.2. Available Models	10
3.3. Hardware Overview	10
3.4. Connector Information	11
3.4.1. Power Input	11
3.4.2. Ethernet Connection TX	12
3.4.3. SHDSL Connection	12
3.4.4. I/O Connection	12
3.4.5. RS-232 Connection (DCE)	13
3.4.6. Connection to the Console Port	13
3.4.7. USB Connection	14
3.5. LED Indicators	15
3.6. Dimensions	16
4. Installation	17
4.1. Mounting	17
4.2. Removal of Product	17
4.3. Cooling	18
4.4. Getting Started	18
4.5. Configuration Via a Web Browser	19
4.6. Factory Default	19
5. Specifications	21
5.1. Interface Specifications	21
5.2. Type Tests and Environmental Conditions	25
6. Revision Notes	28

1. General Information

1.1. Legal Information

The contents of this document are provided “as is”. Except as required by applicable law, no warranties of any kind are made in relation to the accuracy and reliability or contents of this document, either expressed or implied, including but not limited to the implied warranties of merchantability and fitness for a particular purpose. Westermo reserves the right to revise this document or withdraw it at any time without prior notice.

Under no circumstances shall Westermo be responsible for any loss of data or income or any special, incidental, and consequential or indirect damages howsoever caused.

More information about Westermo can be found at www.westermo.com.

1.2. About This Guide

This guide is intended for installation engineers and users of the Westermo products.

It includes information on safety and regulations, a product description, installation instructions and technical specifications.

1.3. Software Tools

Related software tools are available at www.westermo.com/support/software-tools.

1.4. License and Copyright for Included FLOSS

This product includes software developed by third parties, including Free/Libre Open Source Software (FLOSS). The specific license terms and copyright associated with the software are included in each software package respectively. Please visit the product web page for more information.

Upon request, the applicable source code will be provided. A nominal fee may be charged to cover shipping and media. Please direct any source code request to your normal sales or support channel.

1.5. WeOS Management Guide

This product runs WeOS (Westermo Operating System). Instructions for quick start, configuration, factory reset and use of USB port are found in the WeOS Management Guide at www.westermo.com.

2. Safety and Regulations

2.1. Warning Levels

Warning signs are provided to prevent personal injuries and/or damages to the product. The following levels are used:





Level of warning	Description	Consequence personal injury	Consequence material damage
 WARNING	Indicates a potentially hazardous situation	Possible death or major injury	Major damage to the product
 CAUTION	Indicates a potentially hazardous situation	Minor or moderate injury	Moderate damage to the product
 NOTICE	Provides information in order to avoid misuse of the product, confusion or misunderstanding	No personal injury	Minor damage to the product
 NOTE	Used for highlighting general, but important information	No personal injury	Minor damage to the product

Table 1. Warning levels

2.2. Safety Information

Before installation:

Read this manual completely and gather all information available on the product. Make sure it is fully understood. Check that your application does not exceed the safe operating specifications for the product.



WARNING - SAFETY DURING INSTALLATION

The product must be installed and operated by qualified service personnel and installed into an apparatus cabinet or similar, where access is restricted to service personnel only.

During installation, ensure a protective earthing conductor is first connected to the protective earthing terminal (only valid for metallic housings). Westermo recommends a cross-sectional area of at least 4 mm².

If the product does not have a protective earthing terminal, then the DIN-rail must be connected to protective earth. Upon removal of the product, ensure that the protective earthing conductor, or the connection to earth via the DIN-rail, is disconnected last.



WARNING - HAZARDOUS VOLTAGE

Do not open an energized product. Hazardous voltage may occur when connected to a power supply.



WARNING - PROTECTIVE FUSE

It must be possible to disconnect manually from the power supply. Ensure compliance to national installation regulations.

Replacing the internal fuse must only be performed by Westermo qualified personell.



WARNING - POWER SUPPLY CONNECTION

There are safety regulations on which power sources that shall be used in conjunction with the product. Refer to Interface Specifications.



WARNING - REDUCE THE RISK OF FIRE

To reduce the risk of fire, use only telecommunication line cords with a cable diameter of AWG 26 or larger. Regarding power cable dimensions, see Interface Specifications.



CAUTION - CORROSIVE GASES

If the product is placed in a corrosive environment, it is important that all unused connector sockets are protected with a suitable plug, in order to avoid corrosion attacks on the gold plated connector pins.



CAUTION - ELECTROSTATIC DISCHARGE (ESD)

Prevent electrostatic discharge damages to internal electronic parts by discharging your body to a grounding point (e.g. use a wrist strap).



CAUTION - HOT SURFACE

Be aware of that the surface of this product may become hot. When it is operated at high temperatures, the external surface may exceed Touch Temperature Limit according to the product's relevant electrical safety standard.

2.3. Care Recommendations

Follow the care recommendations below to maintain full operation of the product and to fulfill the warranty obligations:

- Do not drop, knock or shake the product. Rough handling above the specification may cause damage to internal circuit boards.
- Use a dry or slightly water-damp cloth to clean the product. Do not use harsh chemicals, cleaning solvents or strong detergents.
- Do not paint the product. Paint can clog the product and prevent proper operation.

If the product is used in a manner not according to specification, the protection provided by the equipment may be impaired.

If the product is not working properly, contact the place of purchase, nearest Westermo distributor office or Westermo technical support.

2.4. Product Disposal

This symbol means that the product shall not be treated as unsorted municipal waste when disposing of it. It needs to be handed over to an applicable collection point for recycling electrical and electronic equipment.

By ensuring the product is disposed of correctly, you will help to reduce hazardous substances and prevent potential negative consequences to both environment and human health, which could be caused by inappropriate disposal.



Figure 1. WEEE symbol for treatment of product disposal

2.5. Compliance Information

2.5.1. Agency Approvals and Standards Compliance

Type	Approval/Compliance
EMC	<ul style="list-style-type: none">• EN/IEC 61000-6-1, Immunity residential environments• EN/IEC 61000-6-2, Immunity industrial environments• EN/IEC 61000-6-3, Emission residential environments^a• EN/IEC 61000-6-4, Emission industrial environments• EN 50121-4/IEC 62236-4, Railway signalling and telecommunications apparatus
Safety	<ul style="list-style-type: none">• UL 60950-1, IT equipment
Marine	<ul style="list-style-type: none">• DNV GL rules for classification - Ships and offshore units^a

^aValid for DDW-142 and DDW-242 24-48 VDC

Table 2. Agency approvals and standards compliance

2.5.2. FCC Part 15.105 Class B Notice

This product has been tested and found to comply with the limits for a Class B digital device, pursuant to Part 15 of the FCC Rules. These limits are designed to provide reasonable protection against harmful interference in a residential installation. This product generates, uses and can radiate radio frequency energy and, if not installed and used in accordance with the instructions, may cause harmful interference to radio communications.

However, there is no guarantee that interference will not occur in a particular installation. If this product does cause harmful interference to radio or television reception, which can be determined by turning the product off and on, the user is encouraged to try to correct the interference by one or more of the following measures:

- Reorient or relocate the receiving antenna
- Increase the separation between the unit and receiver
- Connect the product into an outlet on a circuit different from that to which the receiver is connected
- Consult the dealer or an experienced radio/TV technician for help

2.5.3. Corrosive Environment

This product has been successfully tested in a corrosion test according to IEC 60068- 2-60, method 3. This means that the product meets the requirements to be placed in an environment classified as ISA-S71.04 class G3.



CAUTION - CORROSIVE GASES

If the product is placed in a corrosive environment, it is important that all unused connector sockets are protected with a suitable plug, in order to avoid corrosion attacks on the gold plated connector pins.

2.5.4. Simplified Declaration of Conformity

Hereby, Westermo declares that this product is in compliance with applicable EU directives. The full EU declaration of conformity and other detailed information is available at www.westermo.com/support/product-support.



Figure 2. The European conformity marking

3. Product Description

3.1. Product Description

The Wolverine DDW-142 and DDW-242 allow effective Ethernet networks to be created over long distances up to 15 km (9.3 mi) at data rates up to 15.3 Mbit/s on a single twisted pair cable. By using two pairs “bonded” this rate can be doubled up to 30.6 Mbit/s. The integral switch allows two Ethernet devices to be attached and an RS-232 port allows for a legacy piece of equipment to be incorporated into the IP network.

The operating system (WeOS) in DDW-142 and DDW-242 can deliver unique security functionality for this class of product as well as allowing the product to form part of a resilient multimedia ring network using the Westermo FRNT protocol or industry standard STP/RSTP.

WeOS has been developed to provide industrial networking solutions and contains amazing serial connectivity capability – from being able to simulate an old AT modem, convert Modbus RTU to TCP or encapsulate serial data into an IP packet.

DDW-142 supports the layer 2 features in WeOS while DDW-242 also supports all layer 3 features, for more details please see the WeOS datasheet.

DDW-142 and DDW-242 are incredibly flexible and easy to use. A basic point-to-point or multidrop network can be created without the need for any kind of configuration. However, if a more complex solution requires some kind of network configuration, the web based setup is simple to use. A CLI interface is also provided making the unit easy for networking professionals to quickly master. Once the system is configured, an easy solution is also available for the maintenance engineer – USB backup and restore means that stored configurations can be automatically downloaded from a USB stick.

DDW-142 and DDW-242 are often used in applications on railways, roads or with utilities where failure could result in significant costs. All Westermo products are designed with high MTBF in mind to improve operational reliability and also give long service life. Even features like the SHDSL diagnostics and management allow indication of line degradation, allowing planned maintenance. As the unit is designed for these applications, Westermo also ensure that testing is carried out to ensure the unit can operate at extremes of temperature, EMC and vibration and still provide robust communications.

3.2. Available Models

Art. no.	Model	100 Mbit TX ports	SHDSL ports	Serial ports	Software	Rated voltage
3642-0300	DDW-142	2	2	1	L2	24-48 VDC
3642-0400	DDW-142-12VDC	2	2	1	L2	12-48 VDC
3642-0320	DDW-242	2	2	1	L3	24-48 VDC
3642-0420	DDW-242-12VDC	2	2	1	L3	12-48 VDC

3.3. Hardware Overview

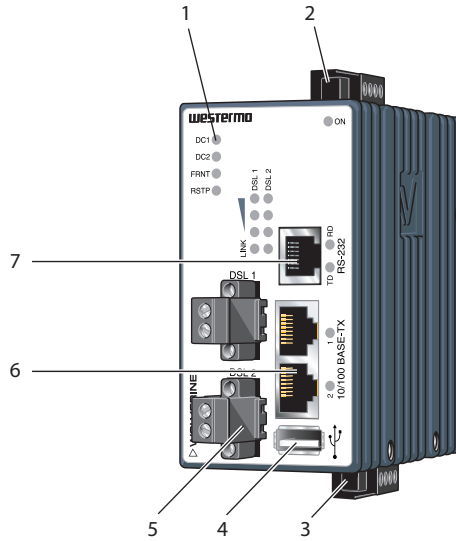

No.	Description	No.	Description
1	LED indicators	2	Power connection
3	I/O connection	4	USB connection
5	SHDSL connection	6	Ethernet connection
7	RS-232 connection		

Figure 3. Location of interface ports and LED indicators

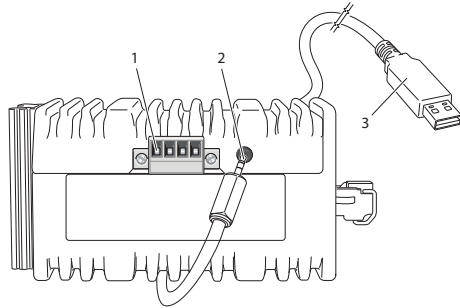

No.	Description	No.	Description
1	I/O connection	2	Console port
3	Accessorie cable, art. no. 1211-2027		

Figure 4. Location of interface ports, bottom view

3.4. Connector Information

3.4.1. Power Input

Illustration	Position	Product marking	Direction	Description
	1	+DC1	Input	Supply voltage
	2	+DC2	Input	Supply voltage
	3	-COM	Input	Common
	4	-COM	Input	Common

Table 3. Power input

The product supports redundant power connection. The positive inputs are +DC1 and +DC2, the negative input for both supplies are -COM. Connect the primary voltage (e.g. +24 VDC) to the +DC1 pin and return to one of the -COM pins on the power input.

3.4.2. Ethernet Connection TX

Illustration	Pin no.	Signal	Direction	Description
	1	TD+	In/Out	Transmitted/Received data
	2	TD-	In/Out	Transmitted/Received data
	3	RD+	In/Out	Transmitted/Received data
	4	-	-	Not connected
	5	-	-	Not connected
	6	RD-	In/Out	Transmitted/Received data
	7	-	-	Not connected
	8	-	-	Not connected
Shield				Connected to PE

Table 4. Ethernet connection TX

3.4.3. SHDSL Connection

Illustration	Pin no.	Direction	Description
	1	In/Out	2-wire Receive/Transmit SHDSL
	2	In/Out	2-wire Receive/Transmit SHDSL

Table 5. SHDSL connection

3.4.4. I/O Connection

Illustration	Pin no.	Product marking	Direction	Description
	1	Status +	Output	Status relay contact (alarm)
	2	Status -	Output	Status relay contact (alarm)
	3	Digital in +	Input	Digital in +
	4	Digital in -	Input	Digital in -

Table 6. I/O connection

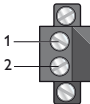
The Status output is a potential free, opto-isolated, normally closed, solid-state relay. This can be configured to monitor various alarm events within the unit, see *WeOS Management Guide*. An external load in series with an external voltage source is required for proper functionality. For voltage/current, see Interface Specifications.

The Digital in is an opto-isolated digital input, which can be used to monitor external events. For voltage/current, see Interface Specifications.

3.4.5. RS-232 Connection (DCE)

Illustration	Pin no.	Signal	Direction	Description
 <p>Pin 8 Pin 1</p>	1	DSR	Out	Data Set Ready
	2	DCD	Out	Data Carrier Detect
	3	DTR	In	Data Terminal Ready
	4	SG	-	Signal Ground, not chassis ground
	5	RD	Out	Receive Data
	6	TD	In	Transmit Data
	7	CTS	Out	Clear To Send
	8	RTS	In	Request To Send

Table 7. RS-232 connection

3.4.6. Connection to the Console Port

The console port can be used to connect to the CLI (Command Line Interface).

1. Connect the serial diagnostic cable to the console port (use only Westermo cable 1211-2027).
2. Connect cable to your computer (USB port, if drivers are needed they can be downloaded from the Westermo web).
3. Use a terminal emulator and connect with correct speed and format (115200, 8N1) to the assigned port.

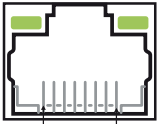
For more information about the CLI, see the WeOS Management guide.

Accessories	
Description	Art. no.
Westermo console cable	1211-2027
RJ45 to terminal block	1200-2490
RJ45 to DB9 cable	1211-2210

Table 8. Accessories table

3.4.7. USB Connection

Illustration	Pin no.	Direction	Description
	1	Out	VBUS
	2	In/Out	D-
	3	In/Out	D+
	4	Out	GND
	5	In/Out	Connected to protective earth

Table 9. USB connection

3.5. LED Indicators

LED	Status	Description
ON	OFF	Product has no power
	GREEN	All OK, no alarm condition
	RED	Alarm condition, or until product has started up. (Alarm conditions are configurable, see <i>WeOS Management Guide</i>)
	BLINK	Location indicator ("Here I am!"). Activated when connected to WeConfig tool, or upon request from web or/and CLI. RED BLINK during boot indicates pending cable factory reset.
DC1	OFF	Product has no power
	GREEN	Voltage present on DC1 ^a
	RED	Voltage failure on DC1
DC2	OFF	Product has no power
	GREEN	Voltage present on DC2 ^a
	RED	Voltage failure on DC2
FRNT	OFF	FRNT disabled
	GREEN	FRNT OK
	RED	FRNT error
	BLINK	Product configured as FRNT focal point
RSTP	OFF	RSTP disabled
	GREEN	RSTP enabled
	BLINK	Product selected as RSTP/STP root switch
USR1 ^b	OFF	Configurable, see <i>WeOS Management Guide</i>
	GREEN	
	RED	
LNK SHDSL ports, link indicator port 1-2	OFF	No DSL link
	GREEN	DSL link established
	GREEN FLASH	DSL link negotiation
	YELLOW	Port alarm and no link. Or if FRNT or RSTP mode, port is blocked.
SHDSL ports, quality indicator ports 1-2	All OFF	No DSL link
	3 RED	Signal to noise value below 3 dB. Unstable DSL link.
	1 GREEN	Signal to noise value 3–5 dB. Marginal DSL link.
	2 GREEN	Signal to noise value 6–9 dB. Normal DSL link.
	3 GREEN	Signal to noise value above 9 dB. Strong DSL link.
RD	OFF	No serial data received
	GREEN FLASH	Serial data received

LED	Status	Description
TD	OFF	No serial data transmitted
	GREEN FLASH	Serial data transmitted
	YELLOW FLASH	Indicates error on RS-232 bus
Ethernet port 1 to 2	OFF	No link
	GREEN	Link established
	GREEN FLASH	Data traffic indication
	YELLOW	Port alarm and no link. Or if FRNT, RSTP or Link Aggregation mode, port is blocked.

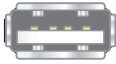
^aSupply voltage levels must be ensured externally. A green LED indicator may not guarantee a valid operating voltage level

^bOnly valid for DDW-242

Table 10. LED indicators

3.6. Dimensions

Dimensions are stated in mm and are regardless of model.

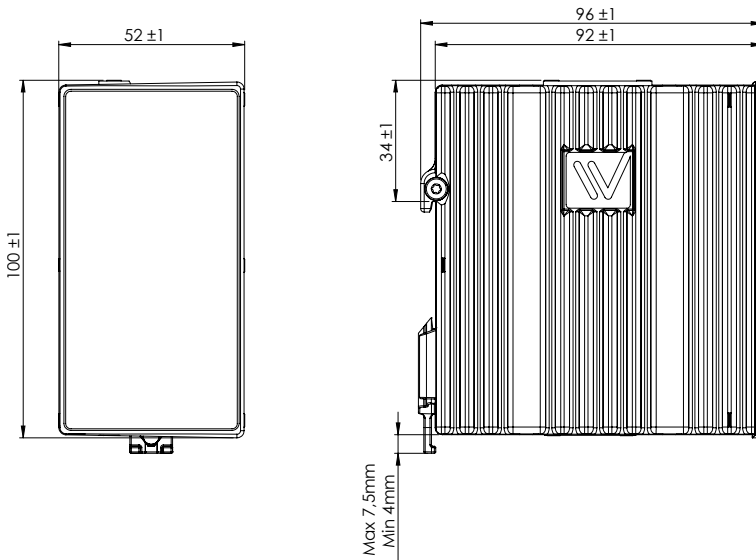

Figure 5. Dimensional drawing

4. Installation

4.1. Mounting

This product should be mounted on a 35 mm DIN-rail, which is horizontally mounted inside an apparatus cabinet or similar. It is recommended that the DIN-rail is connected to ground. Snap on the product to the DIN-rail according to the figure.

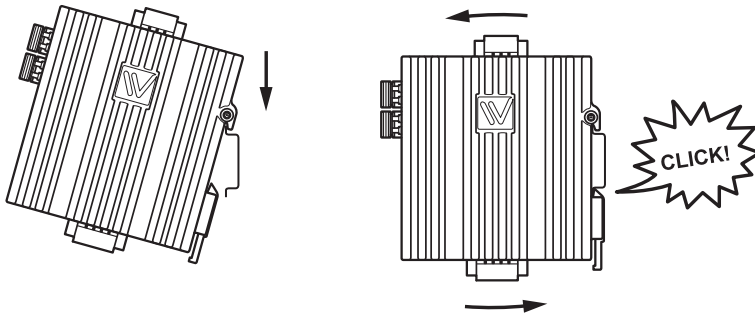

Figure 6. Mounting of product

4.2. Removal of Product

This product has an integrated DIN-clip. To remove the product, press down the support at the back with a screwdriver and lift it off the DIN-rail.

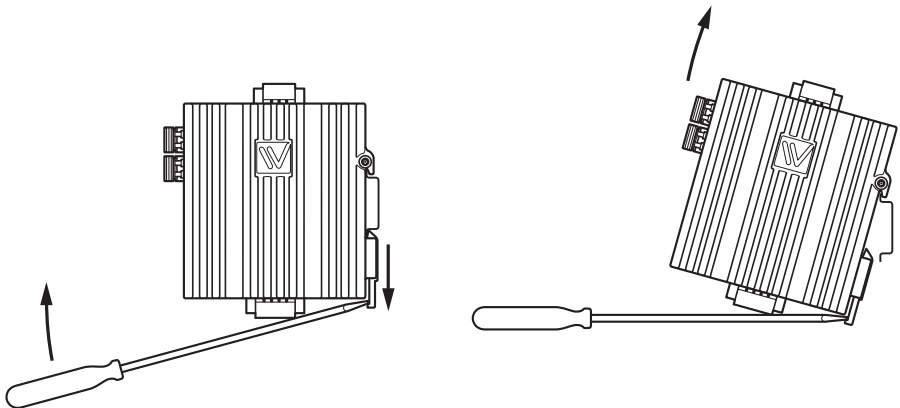

Figure 7. Removal of product

4.3. Cooling

This product uses convection cooling. Spacing is recommended for the use of the product in full operating temperature range and service life. To avoid obstructing the airflow around the product, use the following spacing rules.

Minimum spacing of 25 mm (1 inch) above/below and 10 mm (0.4 inches) left/right of the product is recommended.

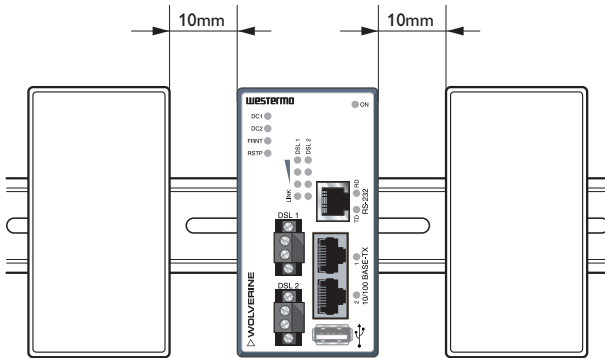

Figure 8. Minimum spacing of product



WARNING - REDUCE THE RISK OF FIRE

To reduce the risk of fire, use only telecommunication line cords with a cable diameter of AWG 26 or larger. Regarding power cable dimensions, see Interface Specifications.

4.4. Getting Started

This product runs the Westermo Operating System (WeOS) which provides several management tools that can be used for configuration of the unit.

- **WeConfig tool**
This is a custom Westermo tool used for discovery of attached Westermo product.
- **Web**
Configuration of the product using the web browser.
- **CLI**
Configuration of the product via the Command Line Interface.
Username: *admin*
Password: *westermo*

If the computer is located in the same subnet as the switch you can easily use a web browser to configure the product. Within the web you can configure most of the available functions. If you are not sure about the subnet – consult your network administrator.

For advanced network settings and more diagnostic information, please use the CLI. Detailed documentation is available in the chapter "The Command Line Management Tool" in the *WeOS Management Guide*.

Factory default:
IP address: 192.168.2.200
Netmask: 255.255.255.0
Gateway: disabled

4.5. Configuration Via a Web Browser

The product can easily be configured via a web browser. Open the link <http://192.168.2.200> in your web browser, and you will be prompted with a login screen, where the default settings are:

Username: *admin*
Password: *westermo*

Once logged in, use the extensive integrated help function describing all configuration options.

Two common task when configuring a new switch is to assign appropriate IP settings, and to change the password of the admin account. The password can be up to 64 characters long, and should consist of printable ASCII characters (ASCII 33-126); 'Space' is not a valid password character.

4.6. Factory Default

It is possible to set the product to factory default settings by using a standard Ethernet RJ-45 cable.

1. Power off the product and disconnect all cables.
2. Connect an Ethernet cable between Ethernet ports 1 and 2. The product needs to be connected directly by an Ethernet cable, i.e., not via a hub or switch. Use a straight cable – not a cross-over cable – when connecting the ports.
3. Power on the product.
4. Wait for the product to start up. Control that the ON LED is flashing red. The ON LED flashing indicates that the product is now ready to be reset to factory default. It is now possible to go ahead the factory reset or to skip factory reset and boot as normal.

To go ahead with factory reset:



NOTE

Do not power off the product while the factory reset process is in progress.

- Acknowledge that you wish to conduct the factory reset by unplugging the Ethernet cables. The ON LED will stop flashing. This initiates the factory reset process and the product will restart with factory default settings. When the product has booted up, the ON LED will show a green light and is now ready to use.

To boot as normal:

- To skip the factory reset process, just wait for approximately 30 seconds (after the ON LED starts flashing RED) without unplugging the Ethernet cable. The product will conduct a normal boot with the existing settings.

5. Specifications

5.1. Interface Specifications

DC, Power port		
	DDW-x42-12VDC:	DDW-x42
Rated voltage	12 - 48 VDC	24 - 48 VDC
Operating voltage	9.8 - 60 VDC	19 - 60 VDC
Rated current	475 mA (765 mA) at 12 VDC (with 500 mA USB load) ^a 245 mA (405 mA) at 24 VDC (with 500 mA USB load) 124 mA (200 mA) at 48 VDC (with 500 mA USB load)	245 mA (405 mA) at 24 VDC (with 500 mA USB load) 124 mA (200 mA) at 48 VDC (with 500 mA USB load)
Rated frequency	DC	
Inrush current, I _t	89 mA ² s at 12 VDC ^a 18 mA ² s at 48 VDC	10.6 mA ² s at 24 VDC 24.7 mA ² s at 36 VDC 42.4 mA ² s at 48 VDC
Startup current ^a	2 × rated current	
Polarity	Reverse polarity protected	
Redundant power input	Yes	
Isolation	All other ports	
Connector	Detachable screw terminal	
Conductor cross section	0.2-2.5 mm ² (AWG 24-12)	
Stripping length cable	7 mm	
Tightening torque, terminal screw	0.5 - 0.6 Nm	
Shielded cable	Not required	
Tightening torque, screw flange	0.3 Nm	

^aRecommended external supply current capability for proper start-up

Ethernet TX	
Electrical specification	IEEE std 802.3
Data rate	10 Mbit/s, 100 Mbit/s, manual or auto
Duplex	Full or half, manual or auto
Circuit type	TNV-1
Transmission range	Up to 150 m with CAT5e cable or better
Isolation	To all other ports
Connection	RJ-45, auto MDI/MDI-X
Cabling	Shielded cable not required, except when installed in Railway application as signalling and telecommunications apparatus and located close to rails ^a
Conductive chassis	Yes
Number of ports	2

^aTo minimise the risk of interference, a shielded cable is recommended when the cable is located inside 3 m boundary to the rails and connected to this port.

The cable shield should be properly connected (360°) to an earthing point within 1 m from this port. This earthing point should have a low impedance connection to the conductive enclosure of the apparatus cabinet, or similar, where the product is built-in. This conductive enclosure should be connected to the earthing system of an installation and may be directly connected to the protective earth.

RS-232	
Electrical specification	EIA RS-232
Data rate	300 bit/s - 115.2 kbit/s
Data format	7 or 8 data bits, odd, even or none parity, 1 or 2 stop bits
Protocol	Transparent, optimised by packing algorithm
Circuit type	SELV
Transmission range	15 m/49 ft
Isolation	To Power, SHDSL, Ethernet
Galvanic connection	To USB, Console
Connection	RJ-45 according to EIA-561
Shielded cable	Recommended
Conductive chassis	Yes
Number of ports	1

I/O connection, Relay output

Maximum voltage/current	60 VDC/80 mA
Connect resistance	Maximum 30 Ω
Isolation	To all other ports
Connector	Detachable screw terminal
Conductor cross section	0.14 - 1.5 mm ² (AWG 28 - 16)
Stripping length cable	7 mm
Tightening torque, terminal screw	0.22 - 0.25 Nm
Tightening torque, screw flange	0.3 Nm

I/O connection, Digital input

Maximum voltage/current	60 VDC/2 mA
Voltage levels	Logic one: >12 V Logic zero: <1 V
Isolation	To all other ports
Connector	Detachable screw terminal
Conductor cross section	0.14 - 1.5 mm ² (AWG 28 - 16)
Stripping length cable	7 mm
Tightening torque, terminal screw	0.22 - 0.25 Nm
Tightening torque, screw flange	0.3 Nm

USB

Electrical specification	USB 2.0 host interface
Data rate	Up to 12 Mbit/s (full speed mode)
Circuit type	SELV
Maximum supply current	500 mA
Connection	USB receptacle connector type A

Console port

Electrical specification	LVTTTL/LVCMOS-level
Data rate	115.2 kbit/s
Circuit type	SELV
Data format	8 data bits, no parity, 1 stop bit, no flow control
Connection	2.5 mm jack, use only Westermo cable 1211-2027

SHDSL	
Electrical specification	ITU-T G.991.2 Annex B
Data rate	32 kbit/s to 30.4 Mbit/s with bonding
Protocol	EMF according to IEEE 802.3
Data format	According to ITU-T G.991.2, depending on line quality
Isolation	To all other ports
Connection	Detachable screw terminal
Conductor cross section	0.2 - 2.5 mm ² (AWG 24 - 13)
Shielded cable	Not required
Number of ports	2

5.2. Type Tests and Environmental Conditions

Environmental phenomena	Basic standard	Description	Test levels
ESD	EN 61000-4-2	Enclosure	Contact: ± 6 kV Air: ± 8 kV
Fast transients	EN 61000-4-4	Power port	± 2 kV
		Ethernet ports	
		SHDSL ports	
		RS-232 port	
		Status out/Digital in	± 1 kV
Earth port			
Surge	EN 61000-4-5	Power port	L-L: ± 0.5 kV, 2Ω , $18 \mu\text{F}$ L-E: ± 0.5 kV, 12Ω , $9 \mu\text{F}$ L-E: ± 2 kV, 42Ω , $0.5 \mu\text{F}$ L-L: ± 1 kV, 42Ω , $0.5 \mu\text{F}$
		Ethernet ports	L-E: ± 2 kV, 2Ω
		SHDSL ports	L-E: ± 2 kV, $R_c=40 \Omega$, $1.2/50 \mu\text{s}$ and $10/700 \mu\text{s}$. Crit A
		RS-232 port	L-E: ± 2 kV, 2Ω
		Status out/Digital in	L-E: ± 2 kV, 42Ω , $0.5 \mu\text{F}$
Pulsed magnetic field	EN 61000-4-9	Enclosure	300 A/m
Radiated RF immunity	EN 61000-4-3	Enclosure	20 V/m at 80 - 1000 MHz 12 V/m at 1 - 2.70 GHz 10 V/m at 2.7 - 6 GHz 1 kHz sine, 80% AM
Conducted RF immunity	EN 61000-4-6	Power port	10 V, 80% AM, 1 kHz; (0.15-80) MHz
		Ethernet ports	
		SHDSL ports	
		RS-232 port	
		Status out/Digital in	
		Earth port	
Radiated RF emission	CISPR 16-2-3 ANSI C63,4 (FCC Part 15)	Enclosure	Class B
Conducted RF emission	CISPR 16-2-1 ANSI C63,4 (FCC Part 15b)	Power port	Class B/DNV bridge
		Ethernet ports	Class B
Dielectric strength	UL 60950-1	Power port to all other isolated ports	1.5 kVrms, 1 min

Environmental phenomena	Basic standard	Description	Test levels
		Ethernet ports to all other isolated ports	1.5 kVrms, 50 Hz, 1 min
		RS-232 port to all other isolated ports	
		SHDSL ports to all other isolated ports	
		Status out/Digital in port to all other isolated ports	

Table 11. EMC and electrical conditions

Environmental phenomena	Basic standard	Description	Test levels
Temperatures	EN 60068-2-1 EN 60068-2-2	Operational	DDW-x42: -40 to +70°C (-40 to +158°F) DDW-x42-12VDC: -40 to +74°C (-40 to +165°F)
		Storage and transport	-40 to +85°C (-40 to +185°F)
Humidity	EN 60068-2-30	Operational	5-95% relative humidity
		Storage and transport	
Corrosive gases ^a	IEC 60068-2-60	Operational	Method 3, 21 days ^b
Altitude		Operational	2000 m/70 kPa
Service life		Operational	10 years
MTBF	MIL-HDBK-217F2, GB, 25 °C		437,000 hours
Vibration	IEC 60068-2-64 (random)	Operational	5 - 20 Hz: 2 m ² /s ³ 20 - 500 Hz - 3 dB/oct 3 axis = 3 x 3 min
Shock	IEC 60068-2-27	Operational	6 ms 1000 m/s ² 6 directions, 3 shocks/direction
Bump	IEC 60068-2-27	Operational	11 ms 100 m/s ² 6 directions, 100 shocks/direction 10 g, 11 ms
Enclosure	EN 60950-1	Zinc	Fire enclosure
Weight			0.8 kg
Degree of protection	EN 60529	Enclosure	IP40
Cooling			Convection

^aValid for DDW-x42, 24-48 VDC

^bMethod 3, 21 days corresponds to Harsh Industrial Environment G3 which is defined in ANSI/ISA 17.04: 2015

Table 12. Environmental and mechanical conditions

6. Revision Notes

Revision	Date	Change description
Rev. Q	2020-11	Westermo logo updated, illustrations updated from brown to blue, new information structure throughout the manual, 1.2 About This Guide - new chapter, 2 Safety and Regulations - entire chapter updated, 3.2. Available Models - new chapter, 4.1 Mounting updated, 4.2 Removal of Product updated, 5.1 Interface Specifications updated, 5.2 Type Tests and Environmental Conditions updated

WESTERMO

Westermo • SE-635 35 Stora Sundby, Sweden

Tel +46 16 42 80 00 Fax +46 16 42 80 01

E-mail: info@westermo.com

www.westermo.com