



Level



Pressure



Flow



Temperature



Liquid
Analysis



Registration



Systems
Components



Services



Solutions

Operating Instructions

Nivotester FTR325

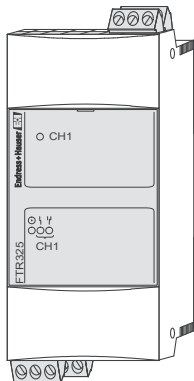

- de** - Füllstandgrenzschalter für die Mikrowellen-schranke Soliwave FDR50/FQR50
- en** - Switching unit for the microwave barrier Soliwave FDR50/FQR50
- fr** - Interrupteur de niveau de remplissage pour barrière à micro-ondes Soliwave FDR50/FQR50
- es** - Interruptor de nivel para la barrera de micro-ondas Soliwave FDR50/FQR50
- it** - Interruttore limitatore per la barriera a micro-onde Soliwave FDR50/FQR50
- nl** - Vulpeilgrensschakelaar voor de microgolff-barriera Soliwave FDR50/FQR50

KA00205F/97/A6/14.16
71278974

Endress+Hauser

People for Process Automation

de - Inhalt

Sicherheitshinweise	4
Geräte-Identifikation	6
Sicherheitshinweise (EX)	8
Einbaulage	10
Anschluss	13
Hinweise zur Symbolik	18
Anzeige- und Bedienelemente	19
Einstellungen	23
Fehlersuche	27
Technische Daten	34
Ergänzende Dokumentation	36

en - Contents

Notes on safety	4
Device identification	6
Notes on safety (EX)	8
Installation	10
Wiring	13
References to the symbols	18
Display and control elements	19
Settings	23
Troubleshooting	27
Technical data	34
Supplementary documentation	36

fr - Sommaire

Consignes de sécurité	4
Identification de l'appareil	6
Consignes de sécurité (EX)	8
Montage	10
Raccordement	13
Symboles utilisés	18
Éléments d'affichage et de configuration	19
Réglages	23
Recherche des défauts	27
Caractéristiques techniques	34
Documentation complémentaire	36

es - Índice de contenido

Notas sobre seguridad	5
Identificación del aparato	6
Notas sobre seguridad (EX)	8
Instalación	10
Conexión	13
Significado de los símbolos	18
Indicador y elementos de control	19
Ajustes	23
Guía de solución de averías	27
Datos técnicos	34
Documentación adicional	36

it - Sommario

Note sulla sicurezza	5
Identificazione dell'apparecchiatura	6
Note sulla sicurezza (EX)	8
Installazione	10
Collegamento	13
Riferimento dei simboli	18
Display ed elementi operativi	19
Impostazione	23
Ricerca guasti	27
Dati tecnici	34
Documentazione supplementare	36

nl - Inhoud

Veiligheidsinstructies	5
Identificatie van het apparaat	6
Veiligheidsinstructies (EX)	8
Inbouw	10
Aansluiting	13
Verwijzing via symbolen	18
Aanwijs- en bedienings-elementen	19
Instellingen	23
Opsporen van storingen	27
Technische gegevens	34
Aanvullende documentatie	36

de - Sicherheitshinweise

Bei unsachgemäßem Einsatz des Geräts können Gefahren von ihm ausgehen. Das Gerät darf **nur von qualifiziertem und autorisiertem Fachpersonal** unter besonderer Beachtung dieser Betriebsanleitung, der einschlägigen Normen, der gesetzlichen Vorschriften und der Zertifikate (je nach Anwendung) eingebaut, angeschlossen und in Betrieb genommen werden.

en - Notes on safety

If used incorrectly it is possible that application-related dangers may arise. The device may be installed, connected, commissioned, operated and maintained **by qualified and authorized personnel only** under strict observance of these operating instructions, any relevant standards, legal requirements and, where appropriate, the certificates.

fr - Consignes de sécurité

Une utilisation non conforme de l'appareil peut constituer une source de danger.

Seul un personnel spécialisé et qualifié, dûment habilité, est autorisé à monter, raccorder et mettre en service l'appareil en respectant les instructions du présent manuel de mise en service ainsi que les normes en vigueur, les directives légales et les certificats (selon l'application).

es - Notas sobre seguridad

Este aparato puede representar un peligro si no es utilizado debidamente. La instalación, conexión y puesta en funcionamiento del aparato debe ser llevada a cabo exclusivamente por **personal técnico cualificado y autorizado** bajo observación especial de estas instrucciones de manejo, las normas correspondientes, las disposiciones legales y de los certificados (según el tipo de aplicación).

it - Note sulla sicurezza

In caso di utilizzo non corretto dell'apparecchiatura possono venire generati dei pericoli. L'apparecchiatura può essere installata, collegata e **messa in funzione solo da parte di personale specializzato, qualificato e autorizzato** che tenga conto in particolare delle presenti istruzioni per l'uso, delle norme applicabili, delle prescrizioni di legge e dei certificati (a seconda dell'applicazione).

nl - Veiligheidsinstructies

Bij onreglementair gebruik van het instrument kunnen er gevaren van uitgaan. Het instrument mag **uitsluitend door gekwalificeerd en geautoriseerd vakpersoneel** met bijzondere inachtneming van deze gebruiksaanwijzing, de ter zake geldende normen, de wettelijke voorschriften en de certificaten (afhankelijk van de toepassing) worden ingebouwd, aangesloten en in gebruik worden genomen.

de - Geräte-Identifikation
 en - Device identification
 fr - Identification de l'appareil
 es - Identificación del aparato
 it - Identificazione dell'apparecchiatura
 nl - Identificatie van het apparaat

Order code FTR325

###

###

###

###

Zertifikat / Certificate / Certificats /
 Certificado / Certificato / Certificaat

B ATEX II (1)G [Ex ia Ga] IIC /

ATEX II (1)D [Ex ia Da] IIIC

D IECEx [Ex ia Ga] IIC /

IECEx [Ex ia Da] IIIC

Y *1



Ausführung / Housing / Modèles /

Modelo / Esecuzione / Uitvoering

1 Hutschienenmontage, b=45mm /

Rail mounting, 45mm broad /

Montage sur rails, largeur = 45mm /

Instalación del riel de perfil de sombrero, b = 45mm /

Montaggio su binario, largh. = 45mm /

Hoedrailmontage, b = 45mm

9 *1

Spannungsversorgung / Power supply /

Alimentation de tension / Alimentación de corriente /

Tensione di alimentazione / Spanningsvoeding

A 85 ... 253 V(AC), 50/60 Hz

E 20 ... 60 V(DC) / 20 ... 30 V(AC), 50/60 Hz

Y *1

Ausgang / Switch output / Sortie /

Salida / Uscita / Uitgang

- 1 1x Füllstand SPDT + 1x Alarm/Füllstand SPST /
1x Level SPDT + 1x Alarm/Level SPST /
1x Niveau de remplissage SPDT + 1x Alarme /
Niveau de remplissage SPST /
1x nivel SPDT + 1x alarma/nivel SPST /
1x livello SPDT + 1x allarme/livello SPST /
1x vulpeil SPDT + 1x alarm/vulpeil SPST
*1

9

- *1 Sonderausführung / Special equipment /
Version spéciale / Ejecución especial /
Versione speciale / Speciale uitvoering

de - Sicherheitshinweise (EX)
 en - Notes on safety (EX)
 fr - Consignes de sécurité (EX)
 es - Notas sobre seguridad (EX)
 it - Note sulla sicurezza (EX)
 nl - Veiligheidsinstructies (EX)



FTR325

FQR50



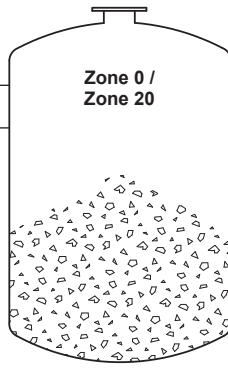

Zone 1 / Zone 21

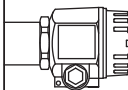

FDR50



ATEX	→	FTR325-B + FQR50/FDR50-C	→	
IECEX	→	FTR325-D + FQR50/FDR50-D	→	

de - Sicherheitshinweise (EX)

- Der Nivotester FTR325 darf nur durch den Hersteller repariert werden.
- Folgende Gerätekombinationen mit der Mikrowellenschranke sind möglich:
FTR325-B* + FQR50/FDR50-C*
FTR325-D* + FQR50/FDR50-D*

es - Notas sobre seguridad (EX)

- El Nivotester FTR325 debe ser reparada exclusivamente por el fabricante.
- Con el barrera de microondas se pueden combinar los siguientes aparatos:
FTR325-B* + FQR50/FDR50-C*
FTR325-D* + FQR50/FDR50-D*

en - Notes on safety (EX)

- The Nivotester FTR325 may be repaired only by the manufacturer.
- The following equipment combinations are possible:
FTR325-B* + FQR50/FDR50-C*
FTR325-D* + FQR50/FDR50-D*

it - Note sulla sicurezza (EX)

- Il Nivotester FTR325 può essere riparata solo da parte del produttore.
- Sono possibili le seguenti combinazioni di apparecchiature con la barriera a microonde:
FTR325-B* + FQR50/FDR50-C*
FTR325-D* + FQR50/FDR50-D*

fr - Consignes de sécurité (EX)

- Le Nivotester FTR325 doit être réparée uniquement par le constructeur.
- Les combinaisons d'appareils suivantes sont possibles avec la barrière à micro-ondes :
FTR325-B* + FQR50/FDR50-C*
FTR325-D* + FQR50/FDR50-D*

nl - Veiligheidsinstructies (EX)

- De Nivotester FTR325 mag alleen de fabrikant worden gerepareerd.
- De volgende instrumentcombinaties zijn mogelijk met de microgolfbarrrière:
FTR325-B* + FQR50/FDR50-C*
FTR325-D* + FQR50/FDR50-D*

de - Einbau

en - Installation

fr - Montage

es - Instalación

it - Installazione

nl - Inbouw

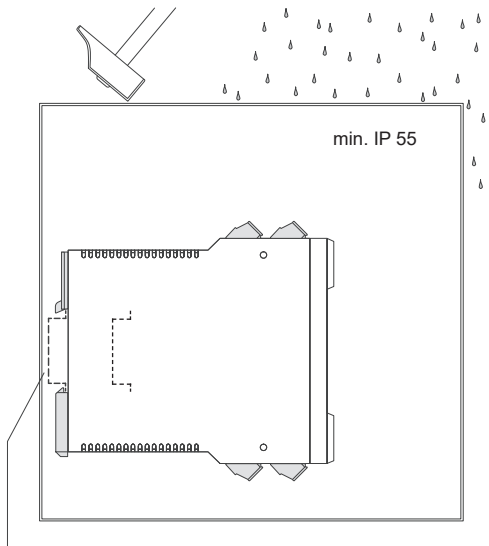

Hutschiene / Mounting rail / Rail profilé /
Rail de montage / Rotaia / Montage-rail

EN 50022 - 35x7.5 / EN 50022 - 35x15

100 mm = 3,94 in



de - Einbau
 en - Installation
 fr - Montage
 es - Instalación
 it - Installazione
 nl - Inbouw

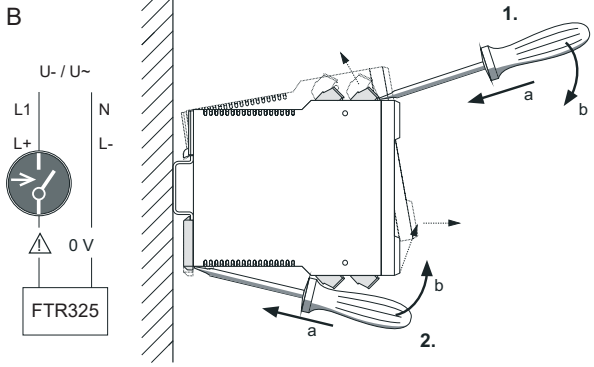
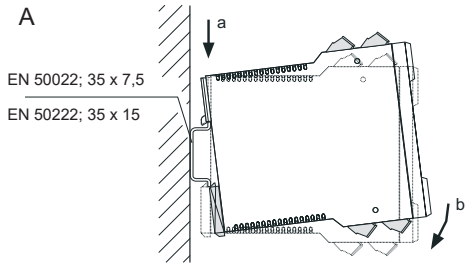

de - Einbau**A** Montage auf Hutschiene**B** Demontage

1. Klemmblöcke entfernen
2. Gerät abnehmen

en - Installation**A** Rail mounting**B** Dismantling

1. Remove the terminal blocks
2. Remove the unit

fr - Montage**A** Montage sur rail profilé**B** Démontage

1. Déconnecter les borniers
2. Oter l'appareil

es - Instalación**A** Montaje en rail**B** Desmontaje

1. Quitar los bornes de conexión
2. Quitar el instrumento

it - Installazione**A** Montaggio su rotaia**B** Smontaggio

1. Togliere il blocchetto morsetti
2. Togliere lo strumento

nl - Inbouw**A** Railmontage**B** Uitbouw

1. Klemmenblok verwijderen
2. Instrument verwijderen

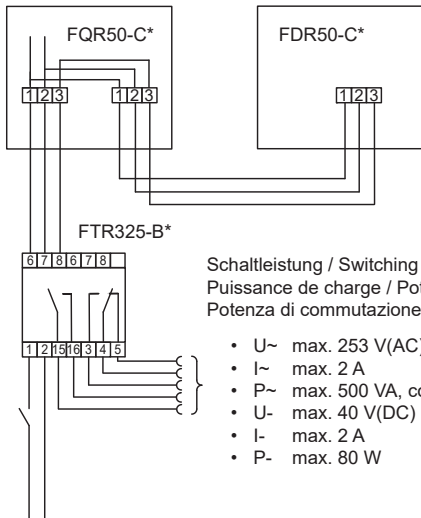

Schaltleistung / Switching load capacity /
 Puissance de charge / Potencia de ruptura /
 Potenza di commutazione / Schakelvermogen

- U~ max. 253 V(AC)
- I~ max. 2 A
- P~ max. 500 VA, $\cos \varphi \geq 0,7$
- U- max. 40 V(DC)
- I- max. 2 A
- P- max. 80 W

Versorgungsspannung / Power supply / Tension d'alimentation /
 Tensión de alimentación / Tensione di alimentazione / Voedingspanning

- U~ 85 ... 253 V(AC), 50 / 60 Hz, 6,9 VA
- U- 20 ... 60 V(DC) / U~ 20 ... 30 V(AC), 50 / 60 Hz, 1,85 W

de - Anschluss
 en - Wiring
 fr - Raccordement
 es - Conexión
 it - Collegamento
 nl - Aansluiting

de - Anschluss
en - Wiring
fr - Raccordement
es - Conexión
it - Collegamento
nl - Aansluiting

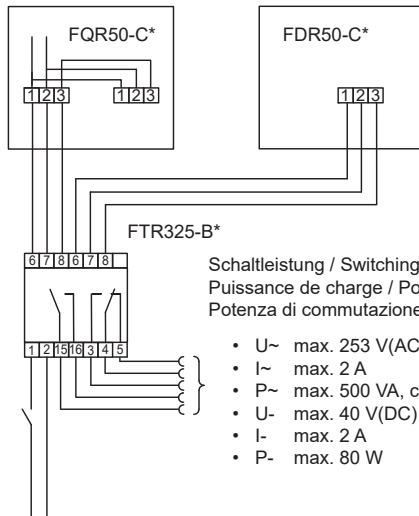

Schaltleistung / Switching load capacity /
 Puissance de charge / Potencia de ruptura /
 Potenza di commutazione / Schakelvermogen

- U~ max. 253 V(AC)
- I~ max. 2 A
- P~ max. 500 VA, $\cos \varphi \geq 0,7$
- U- max. 40 V(DC)
- I- max. 2 A
- P- max. 80 W

Versorgungsspannung / Power supply / Tension d'alimentation /
 Tensión de alimentación / Tensione di alimentazione / Voedingspanning

- U~ 85 ... 253 V(AC), 50 / 60 Hz, 6,9 VA
- U- 20 ... 60 V(DC) / U~ 20 ... 30 V(AC), 50 / 60 Hz, 1,85 W

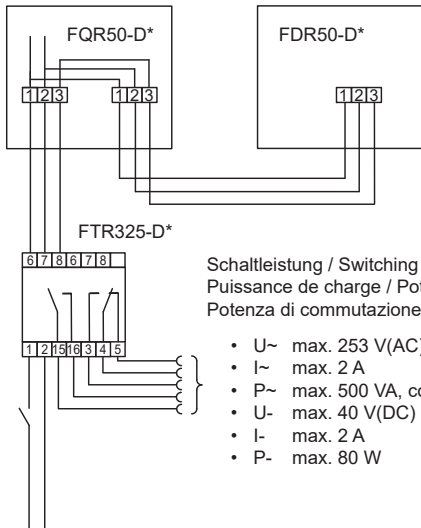

Schaltleistung / Switching load capacity /
 Puissance de charge / Potencia de ruptura /
 Potenza di commutazione / Schakelvermogen

- U~ max. 253 V(AC)
- I~ max. 2 A
- P~ max. 500 VA, $\cos \varphi \geq 0,7$
- U- max. 40 V(DC)
- I- max. 2 A
- P- max. 80 W

Versorgungsspannung / Power supply / Tension d'alimentation /
 Tensión de alimentación / Tensione di alimentazione / Voedingspanning

- U~ 85 ... 253 V(AC), 50 / 60 Hz, 6,9 VA
- U- 20 ... 60 V(DC) / U~ 20 ... 30 V(AC), 50 / 60 Hz, 1,85 W

de - Anschluss
 en - Wiring
 fr - Raccordement
 es - Conexión
 it - Collegamento
 nl - Aansluiting

de - Anschluss
en - Wiring
fr - Raccordement
es - Conexión
it - Collegamento
nl - Aansluiting

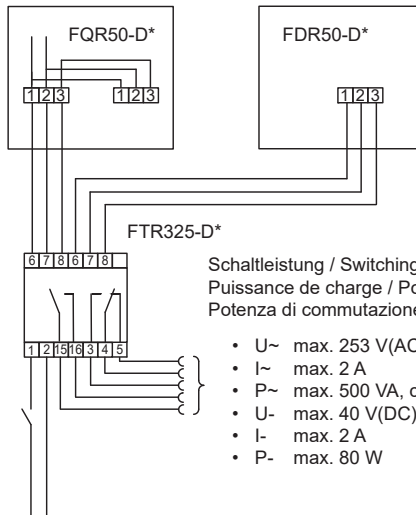

Schaltleistung / Switching load capacity /
 Puissance de charge / Potencia de ruptura /
 Potenza di commutazione / Schakelvermogen

- U~ max. 253 V(AC)
- I~ max. 2 A
- P~ max. 500 VA, $\cos \varphi \geq 0,7$
- U- max. 40 V(DC)
- I- max. 2 A
- P- max. 80 W

Versorgungsspannung / Power supply / Tension d'alimentation /
 Tensión de alimentación / Tensione di alimentazione / Voedingspanning

- U~ 85 ... 253 V(AC), 50 / 60 Hz, 6,9 VA
- U- 20 ... 60 V(DC) / U~ 20 ... 30 V(AC), 50 / 60 Hz, 1,85 W

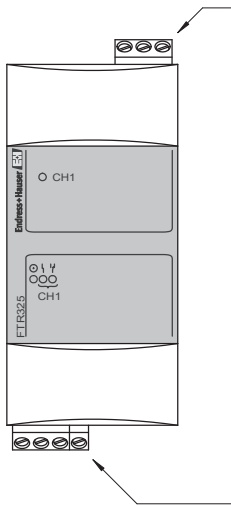

0.2 ... 1.5 mm²



0.6 x 3.5 mm / 0.5 ... 0.6 Nm

de - Anschluss

en - Wiring

fr - Raccordement

es - Conexión

it - Collegamento

nl - Aansluiting

de - Hinweise zur Symbolik
en - References to the symbols
fr - Symboles utilisés
es - Significado de los símbolos
it - Riferimento dei simboli
nl - Verwijzing via symbolen



LED an / LED on / DEL allumée /
Diodo LED on / LED acceso / LED aan



LED aus / LED off / DEL éteinte /
Diodo LED off / LED spento / LED uit

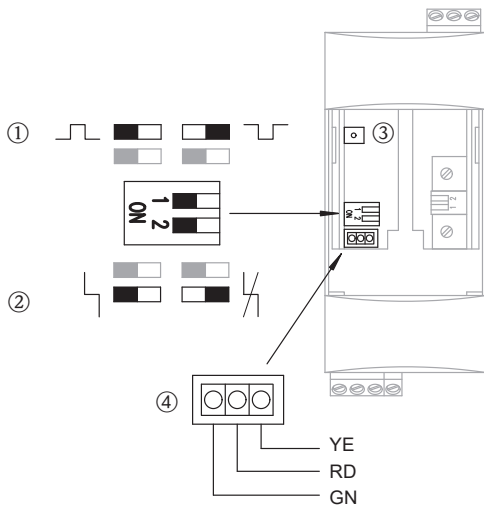

de - Anzeige- und Bedienelemente

en - Display and control elements

fr - Eléments d'affichage et de configuration

es - Indicador y elementos de control

it - Display ed elementi operativi

nl - Aanwijs- en bedienings-elementen



de - Anzeige- und Bedienelemente

- ① Grenzsinalfunktion
- ② Störungsmeldung
- ③ Prüftaste
- ④ LED Zeile:
 - YE - gelb (Schaltzustand)
 - RD - rot (Störung)
 - GN - grün (Betrieb)

en - Display and control elements

- ① Limit signal function
- ② Alarm signal
- ③ Test button
- ④ LED line:
 - YE - yellow (Switch status)
 - RD - red (Fault)
 - GN - green (Working)

fr - Eléments d'affichage et de configuration

- ① Fonction de signal limiteur
- ② Signal d'incident
- ③ Touche de test
- ④ Ligne de DEL:
 - YE - jaune (Statut de commutation)
 - RD - rouge (Incident)
 - GN - vert (Marche normale)

es - Indicador y elementos de control

- ① Función de señalización del límite
- ② Aviso de fallo
- ③ Tecla de prueba
- ④ Línea de diodos LED:
 - YE - amarillo (Estado de conmutación)
 - RD - rojo (Fallo)
 - GN - verde (En servicio)

it - Display ed elementi operativi

- ① Funzione di segnale limite
- ② Segnalazione guasto
- ③ Tasto di verifica
- ④ Fila di LED:
 - YE - giallo (Stato di commutazione)
 - RD - rosso (Guasto)
 - GN - verde (Funzionamento)

nl - Aanwijs- en bedienings-elementen

- ① Grenssignaalfunctie
- ② Storingsmelding
- ③ Testtoets
- ④ LED regel:
 - YE - geel (Schakeltoestand)
 - RD - rood (Storing)
 - GN - groen (In bedrijf)

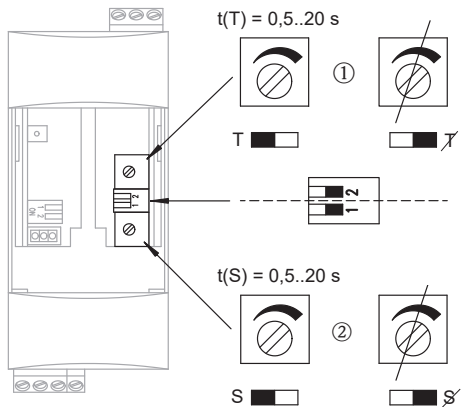

- de** - Anzeige- und Bedienelemente
- en** - Display and control elements
- fr** - Éléments d'affichage et de configuration
- es** - Indicador y elementos de control
- it** - Display ed elementi operativi
- nl** - Aanwijs- en bedienings-elementen

de - Anzeige- und Bedienelemente

Schaltverzögerung:

- ① anzugverzögert
- ② abfallverzögert

en - Display and control elements

Switching delay:

- ① pickup-delayed
- ② dropout-delay

fr - Éléments d'affichage et de configuration

Retard de commutation:

- ① retard d'activité
- ② retard de descente

es - Indicador y elementos de control

Demora de conmutación:

- ① atracción temporizada
- ② tiempo de apertura retardada

it - Display ed elementi operativi

Ritardo di commutazione:

- ① ritardato in salita
- ② ritardato in discesa

nl - Aanwijs- en bedienings-elementen

Schakelvertraging:

- ① aantrekvertraagd
- ② afvalvertraagd

de - Einstellungen















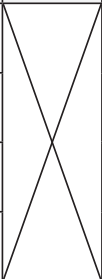





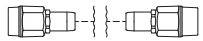









es - Ajustes

en - Settings

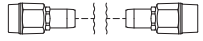
it - Impostazione

fr - Réglages

nl - Instellingen

a			GN	RD	YE		b
							
							
							
							

a Zustand / Condition / Statut / Estado / Stato / Toestand

b Grenzsinal / Limit signal / Signal limiteur / Señal límite / Segnale limite / Grenssignaa

de - Einstellungen
Schaltverzögerung











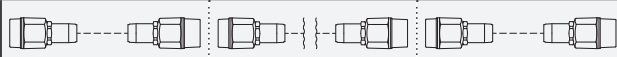



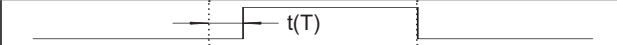

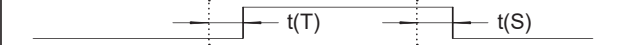

en - Settings
Switching delay

fr - Réglages
Retard de commutation

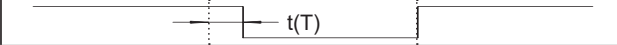
es - Ajustes
Demora de conmutación

it - Impostazione
Ritardo di commutazione

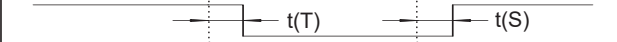
nl - Instellingen
Schakelvertraging

		t(T)	t(S)
		T	S
		T	S
		T	S
		T	S
		T	S
		T	S
		T	S
		T	S

de - Einstellungen
Störung













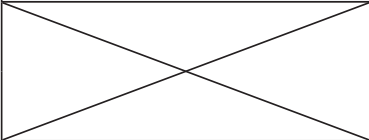









es - Ajustes
Fallos

en - Settings
Fault

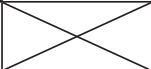
it - Impostazione
Guasti

fr - Réglages
Incident

nl - Instellingen
Storing

a			GN	RD	YE		b
						 15 16	 3 4 5
						 15 16	 3 4 5
c						 15 16	 3 4 5

a Zustand / Condition / Statut / Estado / Stato / Toestand

b Grenzsinal / Limit signal / Signal limiteur / Señal límite / Segnale limite / Grenssigna

c Versorgungsspannung fehlt oder zu gering / Power supply missing or too low / Tension d'alimentation absente ou trop faible /
No existe tensión de alimentación o la tensión de alimentación es demasiado baja / Tensione di alimentazione assente o troppo bassa /
Voedingsspanning ontbreekt of te laag

de - Einstellungen

Funktionstest

en - Settings

Function test

fr - Réglages

Test de fonctionnement

es - Ajustes











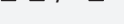



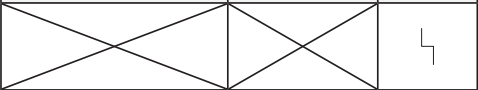
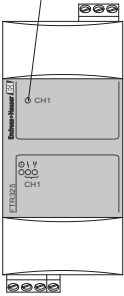





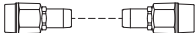







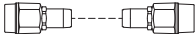

Prueba de funcionamiento

it - Impostazione

Test funzionale

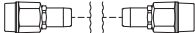
nl - Instellingen

Functietest

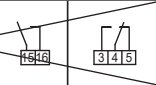
a	 / 							GN	RD	YE		b
												
												
												
												

a Zustand / Condition / Statut / Estado / Stato / Toestand

b Grenzsinal / Limit signal / Signal limiteur / Señal límite / Segnale limite / Grenssignaa

de - Fehlersuche

Der Nivotester FTR325 kann in Verbindung mit der Mikrowellen-schranke Soliwave FDR50/FQR50 folgende Störungen erkennen und zur Anzeige (rote LED) bringen:

- Leitungsbruch in den Versorgungsspannungsleitungen zur Mikrowellenschranke
- Stromaufnahme der Mikrowellenschranke (FQR50/FDR50) zu hoch

es - Guía de solución de averías

El Nivotester FTR325 en combinación con la barrera de microondas Soliwave FDR50/FQR50 puede detectar los siguientes fallos e indicarlos (diodo LED rojo):

- Rotura de línea en los conductos de abastecimiento hacia la barrera de microondas
- Consumo de corriente de la barrera de microondas (FQR50/FDR50) demasiado alto

en - Troubleshooting

The Nivotester FTR325 can in connection with the microwave barrier Soliwave FDR50/FQR50 recognize the following faults and bring them to the announcement (red LED):

- Line break in power supply lines to the microwave barrier
- Power input of the microwave barrier (FQR50/FDR50) is too large

it - Ricerca guasti

Il Nivotester FTR325 se usato unitamente alla barriera a microonde Soliwave FDR50/FQR50 è in grado di riconoscere i seguenti guasti e di segnalarli (LED rosso):

- Interruzione di linea nella linea di alimentazione alla barriera a microonde
- Assorbimento di corrente della barriera a microonde (FQR50/FDR50) troppo elevato

fr - Recherche des défauts



Le Nivotester FTR325 peut, en relation avec la barrière à micro-ondes Soliwave FDR50/FQR50, reconnaître et indiquer les pannes suivantes (diode DEL rouge):



- Interruption de conducteur dans le câble d'alimentation de tension vers la barrière à micro-ondes
- Consommation trop importante de la barrière à micro-ondes (FQR50/FDR 50)

nl - Opsporen van storingen



De Nivotester FTR325 kan in combinatie met de microgolfbarrrière Soliwave FDR50/FQR50 de volgende storingen detecteren en weergeven (rode LED):



- Kabelbreuk in de voedings-spanningsleidingen naar de microgolfbarrrière
- Stroomopname van de microgolfbarrrière (FQR50/FDR50) te hoog



Fehlfunktion	Ursache	Maßnahme
Schaltet nicht	Versorgungsspannung fehlt oder zu gering (grüne LED aus)	Versorgungsspannung überprüfen → 
	Elektronik defekt	FTR325 austauschen
	Kontakte verschweißt (nach einem Kurzschluss)	FTR325 austauschen, Sicherung in den Kontaktstromkreis
	Mikrowellenschanke defekt	Mikrowellenschanke austauschen und zur Reparatur einschicken
Schaltet falsch	Im FTR325 Umschalter für Grenzsignal falsch eingestellt	Umschalter hinter der Frontplatte richtig einstellen → 
Dauernde Störungsmeldung	Unterbrechung oder Kurzschluss der Leitung zur Mikrowellenschanke	Leitung und Anschlüsse überprüfen → 
	Mikrowellenschanke defekt	Mikrowellenschanke austauschen und zur Reparatur einschicken



Fault	Reason	Remedy
Does not switch	No power or power too low (green LED does not light up)	Check power → 
	Electronic defective	Replace FTR325
	Contacts welded together (after short-circuit)	Replace FTR325, connect a fuse into contactor circuit
	Microwave barrier defective	Replace microwave barrier and send it to the manufacturer for reconditioning
Switches incorrectly	Incorrect setting of change- over switch for limit signal	Correctly set change-over switch behind front panel → 
Permanent alarm signal	Interrupt or short-circuit line to microwave barrier	Check line and connections → 
	Microwave barrier defective	Replace microwave barrier and send it to the manufacturer for reconditioning

fr - Recherche des défauts

Fontion défectueuse	Cause	Remède
Ne commute pas	Tension d'alimentation absente ou trop faible (DEL verte éteinte)	Vérifier la tension d'alimentation → 
	Electronique défectueuse	Remplacer FTR325
	Contacts soudés (après un court-circuit)	Remplacer FTR325, Fusible dans le circuit de courant des contacts
	Barrière à micro-ondes défectueuse	Remplacer la barrière à micro-ondes, et l'envoyer en réparation
Commute par erreur	Mauvais réglage du commutateur de signal limiteur	Faire un réglage correct du commutateur derrière la face avant → 
Message d'incident permanent	Interruption ou court-circuit du câble de raccordement à la barrière à micro-ondes	Vérifier la câble et les raccordements → 
	Barrière à micro-ondes défectueuse	Remplacer la barrière à micro-ondes, et l'envoyer en réparation

Fallo	Posible causa	Solución
El aparato no conmuta	No existe tensión de alimentación o la tensión de alimentación es demasiado baja (el diodo LED verde no se ilumina)	Compruebe la tensión de alimentación → 
	La electrónica es defectuosa	Reemplace el FTR325
	Los contactos han sido soldados (tras un cortacircuitos)	Reemplace el FTR325, Conecte un fusible al circuito de contacto
	La barrera de microondas es defectuosa	Reemplace la barrera de microondas y envíela al fabricante para su reparación
El aparato conmuta de forma errónea	Ajuste incorrecto del conmutador FTR325 para la señal límite	Ajuste el conmutador situado detrás del panel frontal correctamente → 
Aviso de fallo constante	Interrupción o cortacircuitos en la línea hacia la barrera de microondas	Compruebe la línea y la conexión → 
	La barrera de microondas es defectuosa	Reemplace la barrera de microondas y envíela al fabricante para su reparación

Errore	Causa	Soluzione
Mancato funzionamento	Tensione di alimentazione assente o troppo bassa (LED verde spento)	Controllare la tensione di alimentazione → 
	Guasto alla parte elettronica	Sostituire l'FTR325
	Contatti saldati male (dopo un corto circuito)	Sostituire l'FTR325, fusibile nel circuito della corrente di contatto
	Barriera a microonde difettosa	Sostituire la barriera a microonde e inviarla per riparazione
Commutazione errata	Il commutatore per il segnale limite nell'FTR325 è impostato in modo errato	Impostare correttamente il commutatore dietro il pannello anteriore → 
Segnalazione continua di guasto	Interruzione o corto circuito della linea alla barriera a microonde	Controllare la linea e i collegamenti → 
	Barriera a microonde difettosa	Sostituire la barriera a microonde e inviarla per riparazione

Funciestoring	Posible causa	Maatregel
Schakelt niet	Voedingsspanning ontbreekt of te laag (groene LED uit)	Voedingsspanning controleren → 
	Elektronica defect	FTR325 vervangen
	Contacten met elkaar versmolten (na een kortsluiting)	FTR325 vervangen, zekering in de contactstroomkring
	Microgolfbarrière defect	Microgolfbarrière vervangen of ter reparatie opsturen
Schakelt verkeerd	In de FTR325 schakelaar voor grenssignaal verkeerd ingesteld	Schakelaar achter de frontplaat correct instellen → 
Permanente storingsmelding	Onderbreking of kortsluiting van de lijn naar de microgolfbarrière	Lijn en aansluitingen controleren → 
	Microgolfbarrière defect	Microgolfbarrière vervangen en ter reparatie opsturen

de - Technische Daten

en - Technical data

fr - Caractéristiques techniques

es - Datos técnicos

it - Dati tecnici

nl - Technische gegevens

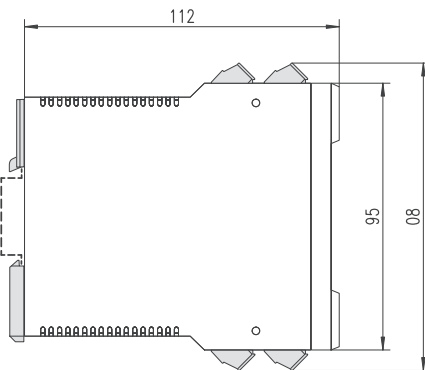
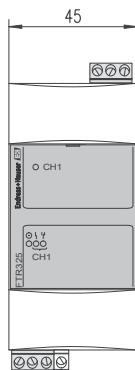

Hutschiene / Mounting rail / Rail profilé /
Rail de montage / Rotaia / Montage-rail
EN 50022 - 35x7.5 / EN 50022 - 35x15

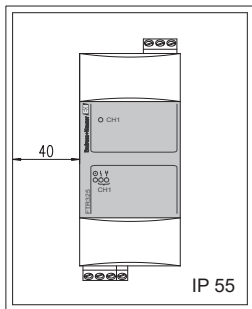

-20°C ... +40°C
-4°F ... +104°F

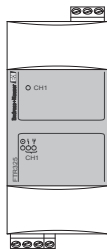

-20°C ... +60°C
-4°F ... +140°F

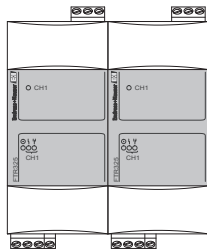

-20°C ... +50°C
-4°F ... +122°F

- de** - Technische Daten
- en** - Technical data
- fr** - Caractéristiques techniques
- es** - Datos técnicos
- it** - Dati tecnici
- nl** - Technische gegevens

Schutzart / Degree of protection / Type de protection / Grado de protección /
Tipo di protezione / Beschermingsklasse: IP 20



de - Ergänzende Dokumentation

en - Supplementary
documentation

fr - Documentation
complémentaire

es - Documentación adicional

it - Documentazione
supplementare

nl - Aanvullende documentatie

Technische Information / Technical information / Information technique /
Información técnica / Informazioni tecniche / Technische informatie

TI00377F Nivotester FTR325

TI00378F Soliwave FQR50/FDR50

Betriebsanleitung / Operation instructions / Manuel de mise en service /
Instrucciones de funcionamiento / Istruzioni operative / Inbedrijfstellingsvoorschrift

KA00206F Soliwave FQR50/FDR50

Sicherheitshinweise / Safety instructions / Conseils de sécurité /
Instrucciones de seguridad / Istruzioni di sicurezza / Veiligheidsinstructies

XA00219F Soliwave FQR50/FDR50-C* + Nivotester FTR325-B*

XA00484F Soliwave FQR50/FDR50-D* + Nivotester FTR325-D*

www.endress.com/worldwide
