

JH3 Servo Motors

Drives



JetWeb

Installation Manual



Edition 2.04

Jetter AG reserves the right to make alterations to its products in the interest of technical progress. These alterations need not be documented in every single case.

This manual and the information contained herein have been compiled with due diligence. However, Jetter AG assumes no liability for printing or other errors or damages arising from such errors.

The brand names and product names used in this document are trademarks or registered trademarks of the respective title owner.

How to Contact us:

Jetter AG
Gräterstraße 2
D-71642 Ludwigsburg
Germany

Phone - Switchboard: ++49 7141/2550-0
Phone - Sales: ++49 7141/2550-433
Phone - Technical Hotline: ++49 7141/2550-444

Telefax - Sales: ++49 7141/2550-484
E-Mail - Sales: sales@jetter.de
E-Mail - Technical Hotline: hotline@jetter.de
Internet address: http://www.jetter.de

This installation manual is an integral part of the JH3 servo motor series:

Type: _____
Serial #: _____
Year of construction: _____
Order #: _____



To be entered by the customer:

Inventory #: _____
Place of operation: _____

© Copyright 2006, 2007 by Jetter AG. All rights reserved.

Significance of this Installation Manual

This installation manual is an integral part of the JH3 synchronous servo motor series

- and must be kept in a way that it is always at hand until the motor of the JH3 synchronous servo motor series will be disposed of.
- If the motor of the JH3 synchronous servo motor series is sold, alienated or loaned, this manual must be handed over.

In any case you encounter difficulties to clearly understand this installation manual, please contact the manufacturer.

We would appreciate any suggestions and contributions on your part and would ask you to contact us. This will help us to produce manuals that are more user-friendly and to address your wishes and requirements.

This installation manual contains important information on how to transport, erect, install, operate, maintain, and repair the motors of the JH3 synchronous servo motor series.

Therefore, this person must carefully read, understand and observe this manual, and especially the safety instructions.

Missing or inadequate knowledge of the manual results in the loss of any claim of liability on part of Jetter AG. Therefore, the operating company is recommended to have the instruction of the persons concerned confirmed in writing.

History

Revision	Comment
2.01	Original issue
2.02	Thermostatic circuit-breaker KTY83-110 new
2.03	The connectors of the option S-X are positioned 7 mm higher
2.04	See Appendix A: "Recent Revisions", page 52

Description of Symbols



Danger

Indicates a hazardous situation which, if not avoided, will result in death or serious injury.



Warning

Indicates a hazardous situation which, if not avoided, could result in death or serious injury.



Caution

Indicates a hazardous situation which, if not avoided, could result in minor or moderate injury. This sign is also to warn you of material damage.



This sign indicates hazard of life due to electric shock caused by a high operating voltage.



This sign is to indicate hazard of serious physical damage or death due to accidentally touching dangerous parts of the device.



You are asked to wear goggles. Failure to comply may lead to bodily injuries.



This sign is to warn you of material damage due to applying hard blows or shocks to the motor flange and shaft.

**Important**

This sign is to indicate a possible impending situation which might bring damage to the product or to its surroundings.
It also identifies requirements necessary to ensure faultless operation.

**Note**

You will be informed of various possible applications and will receive further useful suggestions.
It also gives you words of advice on how to efficiently use hardware and software in order to avoid unnecessary efforts.

· / -

Enumerations are marked by full stops, strokes or scores.



Operating instructions are marked by this arrow.



Automatically running processes or results to be achieved are marked by this arrow.



PC and user interface keys.



This symbol informs you of additional references (data sheets, literature, etc.) associated with the given subject, product, etc. It also helps you to find your way around this manual.

Table of Contents

1	Safety Instructions	9
1.1	Generally Valid Safety Instructions	9
1.1.1	Usage as Agreed Upon	9
1.1.2	Usage Other Than Agreed Upon	10
1.1.3	Who is permitted to operate the JH3 servo motor?	10
1.1.4	Modifications and alterations to the motor	10
1.1.5	Repairing and servicing the JH2 servo motor	10
1.1.6	Decommissioning and disposing of the JH2 servo motor	11
1.2	Ensure Your Own Safety	11
1.2.1	Malfunctions	12
1.2.2	Information Signs and Labels	12
1.2.3	Earthing procedure	12
1.2.4	Operating the holding brake ensuring personal safety	12
1.3	Residual Dangers	13
1.3.1	Hazards during Operation	13
1.3.2	Hazards after POWER is turned OFF	15
1.4	Instructions on EMI	15
2	Installation of the Servo Motor	17
2.1	Scope of Delivery	17
2.2	Important Notes	18
2.2.1	Ambient conditions	18
2.2.2	Avoiding damages	19
2.3	Mechanical Installation	21
2.4	Electrical Installation	23
2.5	Checking the Installation	24
2.6	Notes on Safety as regards the Installation	25
2.7	Notes on Safety as regards Commissioning	26
3	Operating Conditions	27
4	Type Designation	28
5	Physical Dimensions	30
6	Technical Data	31
7	Description of Connections	36
7.1	Motor Connection by means of the Motor Connector Series SC	36
7.1.1	General remarks	36
7.1.2	Motor power cable with mating connector	37

7.1.3	Motor power cable for JetMove 2xx	38
7.1.4	Motor power cable for JetMove 6xx	40
7.1.5	Connection assignment of terminal box	42
7.2	Connection of the Resolver	43
7.2.1	Motor power cable with mating connector	43
7.2.2	Resolver cable for JetMove 2xx	44
7.2.3	Resolver cable for JetMove 6xx	45
7.3	HIPERFACE connection	46
7.3.1	HIPERFACE cable with mating connector	46
7.3.2	HIPERFACE cable for JetMove 2xx	47
7.3.3	HIPERFACE cable for JetMove 6xx	48
8	Maintaining the Motor	49
9	Troubleshooting	50

List of Appendices

Appendix A:	Recent Revisions	52
Appendix B:	Glossary	53
Appendix C:	List of Illustrations	57
Appendix D:	Index	58

1 Safety Instructions

1.1 Generally Valid Safety Instructions

The JH3 synchronous servo motor series complies with the safety regulations and standards in force. Special emphasis was given to the safety of the users.

Of course, the user should adhere to the following regulations:

- relevant accident prevention regulations;
- accepted safety rules;
- EC guidelines and other country-specific regulations.

1.1.1 Usage as Agreed Upon

Usage as agreed upon includes operation in accordance with this installation manual.

The JH3 series of synchronous servo motors belongs to the category of brushless permanently excited precision motors of sine-shaped induced voltage.

The JH3 synchronous servo motors have explicitly been designed for being torque, speed, and/or position controlled by specific servo amplifiers, such as JetMove xxx made by Jetter AG. This motor has not been designed for direct connection to the three-phase supply network. Direct connection to the mains will result in destruction of the motor.

The JH3 synchronous servo motor series may only be operated within the limits of the stated data, see chapter 6 "Technical Data", page 31.

The rated AC voltage of the motors is 190 V, respectively 310 V. The winding isolation of the motors is rated at 560 V. During braking operation the DC link voltage of the servo amplifier, however, can amount up to DC 850 V. Thus, the motor is subject to the EC Low Voltage Directive.

The JH3 synchronous servo motor series has especially been designed as a drive for machines that put high demands on dynamic performance and endurance. The JH3 servo motors may **only** be run under the operating conditions specified in this installation manual; see chapter 3 "Operating Conditions", page 27.

The JH3 synchronous servo motors are installed in machines; they may only be commissioned as devices integrated in specific plants.

The values rendered by the thermistor that is integrated into the motor windings must be evaluated and monitored.

The JH3 synchronous servo motors are used for driving machinery, such as conveyors, production machines, and handling machines.

1.1.2 Usage Other Than Agreed Upon

The JH3 synchronous servo motor series must not be used in technical systems which to a high degree have to be fail-save, e.g. ropeways and aeroplanes.

If the JH3 synchronous servo motors are to be run under surrounding conditions, which differ from the conditions mentioned in chapter 3 "Operating Conditions", page 27, the manufacturer is to be contacted beforehand.

1.1.3 Who is permitted to operate the JH3 servo motor?

Only instructed, trained and authorised persons are permitted to operate the JH3 synchronous servo motor series.

Transport:	Only by personnel with knowledge in handling electrostatically sensitive components.
Installation:	Only by specialists with training in mechanical and/or electrical engineering.
Commissioning:	Only by specialists with extensive knowledge of, and experience with, electrical engineering / drive technology.

1.1.4 Modifications and alterations to the motor

For safety reasons, no modifications and changes to synchronous servo motors of the JH3 series and to their functions are permitted.

Any modifications to the motor not expressly authorised by the manufacturer will result in a loss of any liability claims to Jetter AG.

The original parts are specifically designed for the JH3 synchronous servo motor series. Parts and equipment of other manufacturers are not tested on our part, and are, therefore, not released by us.

The installation of such parts may impair the safety and the proper functioning of the motor.

Any liability on the part of Jetter AG for any damages resulting from the use of non original parts and equipment is excluded.

1.1.5 Repairing and servicing the JH3 servo motor

The synchronous servo motors of the JH3 series must not be repaired by the operator. The synchronous servo motors of the JH3 series do not contain any parts that could be repaired by the operator.

If a JH3 synchronous servo motors needs repairing, please send it to Jetter AG.

For information on servicing the JH3 synchronous servo motors refer to chapter 8 "Maintaining the Motor", page 49.

1.1.6 Decommissioning and disposing of the JH3 servo motor

The environmental regulations for the respective country apply to decommissioning and disposing of the JH3 synchronous servo motors on the operating company's premises.

1.2 Ensure Your Own Safety



Danger

➤ Disconnect the JH3 synchronous servo motor from the electricity mains to carry out maintenance work. By doing so, you will prevent accidents resulting from electric voltage and moving parts. Please follow the information given in chapter 1.3 "Residual Dangers", page 13.

➤ Safety and protective devices, e.g. the guard, cover of the terminal box or the thermal motor circuit-breaker must not in any case be shunted or bypassed.

➤ Dismantled protective equipment, such as the guards and the thermal protection units of the motor, must be reattached prior to commissioning and checked for proper functioning.

➤ **Do not wear protective gloves** for fitting protective equipment. If the motor shaft starts turning inadvertently, the protective gloves could get caught in it.





Danger



➤ The JH3 synchronous servo motor can become over 130 °C hot during operation without being damaged. For your own protection, do not touch the motor with bare hands (hazard of burning) before measuring the temperature of the motor enclosure. The machine manufacturer must see to an adequate protection against accidental contact being installed.

➤ Before commissioning, the machine manufacturer must carry out a hazard analysis of the respective machine and take adequate measures so that inadvertent motions will not lead to personal injury and to material damage.



1.2.1 Malfunctions

-  **In case of failures or damages, disconnect the motor from the mains immediately.**
Please follow the information given in chapter 1.3 "Residual Dangers", page 13.
-  Malfunctions or other damages are to be reported to an authorised person at once.
-  Secure the JH3 synchronous servo motors against improper or inadvertent use.

1.2.2 Information Signs and Labels

-  Writings, information signs, and labels always have to be observed and kept readable.
-  Damaged or unreadable information signs and labels are to be exchanged.

1.2.3 Earthing procedure

-  Please mind proper earthing of servo amplifier and servo motor.
-  Please ensure correct, low-resistance grounding of the frame by PE reference potential in the control cabinet, as otherwise safety of persons will not be guaranteed.
-  The frame should have a conductive, low-resistance connection with the machine into which the servo motor has been integrated.

1.2.4 Operating the holding brake ensuring personal safety

The holding brake can be controlled by the servo amplifier directly. In this case, though, the safety of persons is not guaranteed, as suppression of the brake winding is carried out without an additional external safety circuit.

If the holding brake is not controlled by the servo amplifier directly, an additional circuit, e.g. by means of a varistor, must be provided. An operation of the holding brake that is safe for personnel requires an additional normally open contact in the brake circuit and a suppressor device, e.g. a varistor, for the brake circuit.

1.3 Residual Dangers

1.3.1 Hazards during Operation

HAZARD caused by high operating voltage!



Danger

Extremely hazardous voltages of up to DC 900 V may occur!

Such voltages may result in muscle cramps, burns, unconsciousness, respiratory standstill, or death.



Danger



Do not touch or undo electrical connections of the synchronous servo motor while it is live.

The power connections may still be live, even though the motor is not turning. The operating voltage can amount to up to 900 V.

There is a danger of electric arcing which is a danger to persons and to contacts.



Check all live parts for protection by an electrical barrier.

Hot surface HAZARD!



Danger

The JH3 synchronous servo motor can heat up during operation. The surface temperature of the motor can exceed 130 °C.



Do not touch the JH3 synchronous servo motor during operation or during the cooling-off period following the switching off of the amplifier.



If there are temperatures exceeding 60 °C, please install protection against accidental contact.



Please make sure that no temperature-sensitive parts have been connected or fastened to the motor.



Danger

HAZARD in explosive gas atmosphere!



Do not apply the JH3 synchronous servo motor in potentially explosive areas.



Warning

Hazardous mechanic force!

This servo motor can move mechanic parts or sharp edges. Therefore, failure or malfunctioning of the amplifier or motor can be dangerous to persons or damage the manufacturing plant. This should be prevented by adequate safety precautions, for example:

- One safety precaution is to install a second set of limit switches to interrupt the power supply of the motor.
- Another safety precaution would be installing a guard.



Make sure that hazards to persons or material damage are precluded even when the drive is rotating unintentionally.



Do not remove any guards.



Do not wear gloves, lest they should get caught in the rotating drive shaft.



Never touch a rotating drive shaft.



Warning

HAZARD by feather keys coming loose!



Warning

Some motor shafts come with a feather key. If such a shaft is not equipped with a drive output element (e.g. gearwheel, sprocket, pulley), the feather key can come loose when the shaft is spinning.



For this reason, wear goggles when the motor shaft is spinning.

1.3.2 Hazards after POWER is turned OFF

DANGER resulting from electric shock!

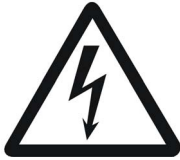

Danger

Capacitors of the servo amplifier can store dangerous voltages for at least 7 minutes after the power has been switched off. The control and power connections may still be live, even though the motor is not turning.



Do **never** disconnect the motor when it is under voltage.



Wait **at least** 7 minutes after switching off before disassembling the motor or disconnecting the servo amplifier and the motor from the mains.

1.4 Instructions on EMI

The JH3 synchronous servo motor series has been designed for industrial use. It may cause radio interferences when used in residential areas. It is operated at the operator's own risk.

The noise immunity of a system corresponds to the weakest component of the system. For this reason, correct wiring and shielding of cables is of paramount importance.



Important!

Measures for increasing immunity to interference:



Ground the panel and the frame according to chapter 1.2.3 "Earthing procedure", page 12.



Connect the resolver respectively the HIPERFACE.



Connect the motor lines. The toroidal cores or the motor choke must be placed near the servo amplifier. Shield cables on both ends.



Connect holding brake, if available, and connect shields at both sides of the cables.

- If a motor power cable is used which includes cores for brake control, the brake control cores must be shielded separately. Earth the shielding braid on both ends. The shielding braid must be placed on both ends of the applicable cables.
- Follow the instructions given in Application Note 016 "EMC-Compatible Installation of the Electric Cabinet" published by Jetter AG.

The following instructions are excerpts from Application Note 016:

- On principle, **physical separation** should be maintained between signal and power lines. We recommend spacings greater than 20 cm. Cables and lines should cross each other at an angle of 90°.
- All cables must be of a sufficient cross-section.
- Shielded cables **must** be used for the following lines:
Analog lines, data lines, motor cables coming from inverter drives (servo output stage, frequency converter), lines between components and interference suppressor filter, if the suppressor filter has not been placed at the component directly.
- Shield cables **at both ends**.
- Unshielded wire ends of shielded cables should be as short as possible.
- The entire shield **must**, in its entire perimeter, be drawn behind the isolation, and then be clamped under an earthed strain relief **with the greatest possible surface area**.
- The shield (impedance shielding) **must**, in its entire perimeter, be drawn behind the shielding clamp of the metallised connector housing, respectively of the EMC gland bushing, its greatest possible surface area being clamped under a strain relief.

2 Installation of the Servo Motor

2.1 Scope of Delivery

- Synchronous servo motor of the JH3 series
- Installation Manual

Mounting Accessories (not included in the scope of delivery)

- Motor power cable, see chapter 7.1.2 "Motor power cable with mating connector", page 37.
- Resolver cable or HIPERFACE cable, see chapter 7.2.1 "Motor power cable with mating connector", page 43, and chapter 7.3.1 "HIPERFACE cable with mating connector", page 46.
- Digital servo amplifier, e.g. JetMove 2xx or JetMove 6xx.



Note!

If you are not sure which accessories you will need:
The sales staff of Jetter AG will gladly assist you in the selection.

2.2 Important Notes



Important!



Please read this installation manual before installing and commissioning this servo motor.



Please keep to the terminal conditions (nameplate and installation manual) and to the technical data of the motor, see chapter 6 "Technical Data", page 31.



Please check the assignments of servo amplifier and motor. Compare the continuous rated current and the rated AC voltage of servo amplifier and motor.

Carry out the wiring according to the electric connection diagrams shown in a manual, e.g. in the operator's manual of the applied servo amplifier JetMove 2xx or JetMove 6xx.

2.2.1 Ambient conditions

For the installation site of the JH3 synchronous servo motor, please give heed to the following surrounding conditions:

- Ambient conditions: -20 °C .. +40 °C
- Maximum height of installation position: 1,000 m above sea level
- Relative humidity: 15 .. 85 % (non-condensing)



Important!

In case of a deviation from the ambient conditions specified above, derating might be necessary.

The synchronous servo motor of the JH3 series is not apt for installation in the open air, nor in a corrosive or contaminated atmosphere. Such ambient conditions will have negative effects on the service life of the motor.

2.2.2 Avoiding damages



Caution



Do **not** run the JH3 synchronous servo motor at the three-phase supply network directly. The motor **must** be connected to a servo amplifier designed for that purpose, e.g. a JetMove xxx.

Direct connection to the mains will result in destruction of the motor.



Do not apply excess force when mounting the motor.



Do **by all means** refrain from applying hard blows or shocks to the motor flange and shaft.



For fitting backlash-free output shafts with friction locking, please do by all means only use the specifically designed tightening thread in the motor shaft and warm up the power output elements, if possible.

Fitting the power output elements may only be carried out by means of suitable tools. Please follow the instructions given by the power output element manufacturers.

A special hint: Apply double-conical collets.



Make sure the clutch is aligned correctly. Please follow the instructions given by the manufacturer of the clutch.

An offset will produce intolerable vibrations and will damage ball bearings and clutch.



When using timing belts by all means observe the permissible radial forces F_R .

Radial loads exceeding the limits will significantly reduce the service life of motors.

If a belt drive is used, the minimum permitted diameter of the pinion, for example, is calculated as follows: $d_{\min} \geq M_0/F_R \times 2$.



If possible, avoid axial load of the motor shaft.

Axial load will significantly shorten the service life of the motor.



When configuring the digital servo amplifier, make sure that the correct number of motor poles and of resolver poles is set.

Faulty settings can result in overheating and destruction of the motor.

JH3 synchronous servo motor series:

- Number of motor poles: 6
- Number of resolver poles: 2



Please make sure there is sufficient heat dissipation, especially at the flange side of the motor. Derate the motor output, if necessary.

During operation with rated data, the flange temperature of 65 °C must not be exceeded.

The thermistor of the motor must be integrated into the monitoring system of the servo amplifiers.



All torque data have been determined for motors equipped with cooling plates. For calculating the 3.5 mm thick cooling plates, the following formula has been applied:

Length of cooling plate in mm = 6.25 x flange size in mm

Example:

Cooling plate for a JH3-0053-...-motor = 6.25 x 55 mm = 343.75 mm

The following cooling plate will result for JH3 motor types:

343.75 mm x 343.75 mm x 3.5 mm

2.3 Mechanical Installation



Prior to installing the motor, check it for possible damages in transit and/or storage.

Please do notify us without delay of damaged mechanical equipment, as well as of corrosion damages to shaft or flange.

If there is a brake, release it first. Try to turn the rotor by hand; it must react easily. Watch out for unusual scraping noises.



At manufacturing, the rotor of the motor is balanced electronically.

Before fitting the power output elements to the end of the shaft, remove the corrosion protection that might still be covered with.



Do **by all means** refrain from applying hard blows or shocks to the motor flange and shaft.



For fitting clutches, gear wheels or pulleys, please do by all means only use the specifically designed tightening thread in the motor shaft, see Fig. 1, and warm up the power output elements, if possible.

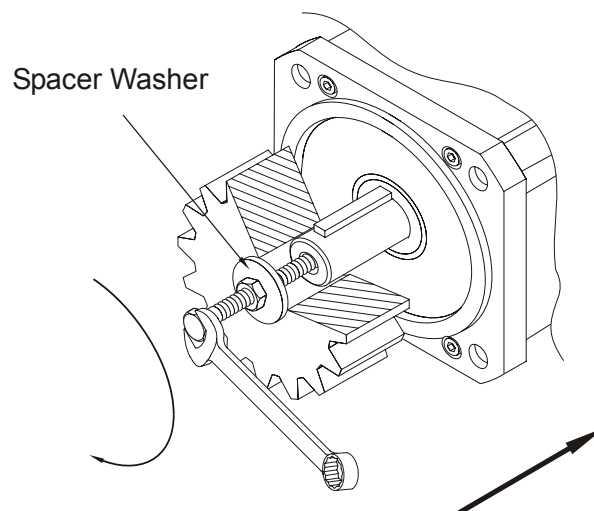

Fig. 1: Example: Fitting a power output element



For fitting power output elements use as far as possible only frictional collets and clutches which are free from backlash.

Please pay attention to the correct alignment of the coupling (as little unbalanced mass as possible).

A balance error produces vibrations and will damage ball bearings and coupling.



Check power output elements (coupling, gearbox, pulley) for tight fit and correct set-up.

- Please give heed to the admissible radial and axial forces. For this, please, do also **by all means** read the chapter 2.2.2 "Avoiding damages", page 19.
- **By all means** avoid a hyperstatic arrangement of the motor shaft bearings by using a rigid clutch and an external additional bearing (e.g. in the gearbox).
- The installation location must be free from conductive and corrosive substances.
For encapsulated installation, please consult our application department.
- Protect the motors against liquids soaking into the bearing in case the shaft end is installed upwards (design V1); refer to Fig. 2.

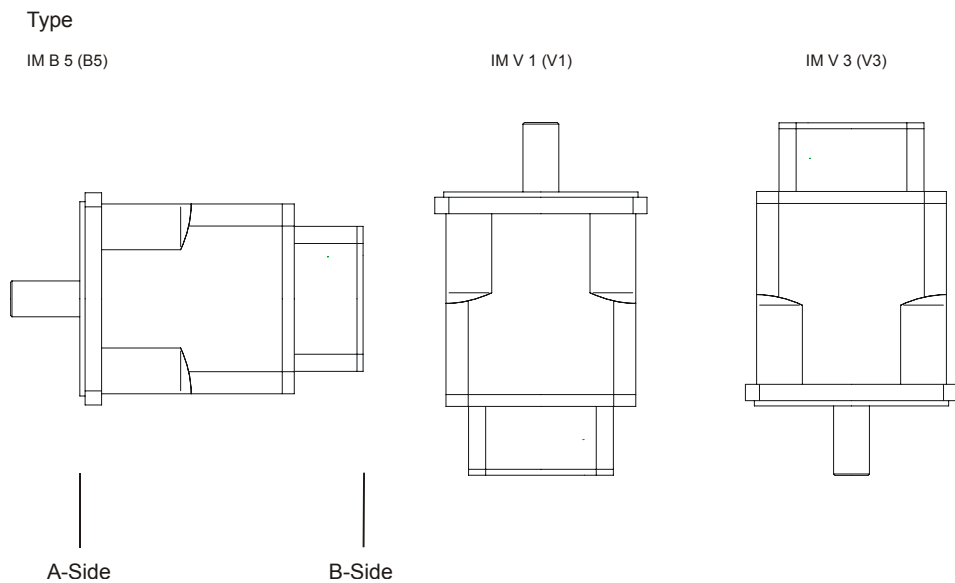

Fig. 2: Mounting Positions of JH3 Motors

- Ensure unobstructed ventilation of the JH3 synchronous servo motor and observe the maximum ambient and flange temperatures. The permitted ambient temperature has been specified in chapter 3 "Operating Conditions", page 27. The maximum permitted flange temperature during operation is 65 °C.
- In order to remove gears, pulleys etc. please use a pulling device according to Fig. 3.

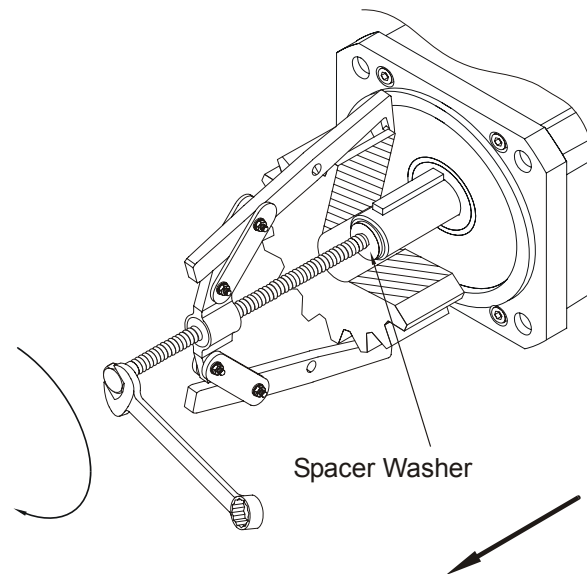

Fig. 3: Removing a power output element

2.4 Electrical Installation

- Have installation jobs carried out by qualified personnel only, see chapter 1.1.3 "Who is permitted to operate the JH3 servo motor?", page 10.
- Please check the assignments of servo amplifier and servo motor. Compare the continuous rated current and the rated AC voltage of servo amplifier and motor.
- The cable diameter must be designed according to the continuous rated current of the motor. Please do also observe the ambient conditions, the mode of installation and the local regulations.
- To connect resolver, HIPERFACE or power units, you can use prefabricated cables available from Jetter, or opt for self-made cables. Please refer to chapter 7 "Description of Connections", page 36.
- All cables and pipes have to be run in a way that nobody gets entangled in them. When laying lines, the bending radiuses must be observed.
- Carry out the wiring according to the electric connection diagrams shown in the manual, e.g. in the operator's manual of the applied servo amplifier JetMove xxx.
- Check whether all ground cables are connected, see chapter 1.2.3 "Earthing procedure", page 12.



- For installation according to EMC, the chapter 1.4 "Instructions on EMI", page 15 must be read and observed.
- In addition, the explanations given in the operating manual of the respective servo amplifier, e. g. JetMove xxx, are to be observed. In particular, connect the shields according to the connection diagrams given in the operating manuals of the servo amplifiers.

2.5 Checking the Installation

- Check servo motor and servo amplifier wiring and connections by means of the connection diagrams used.
- A possibly existing holding brake must be checked for proper functioning (attach DC 24 V, the brake must be released then).
- Check to see whether the rotor of the motor can be turned easily (a possibly existing brake must be released beforehand). Watch out for possible unusual scraping noises.
- Check to see whether all necessary protection measures against accidental contact with live or moving parts have been taken.
- Carry out any other checks specific to or required for your system.
- Please do by all means set the correct number of motor poles and of resolver poles.
Faulty settings can result in overheating and destruction of the motor.

JH3 synchronous servo motor series:

- Number of motor poles: 6
- Number of resolver poles: 2

Note:

For the digital servo amplifiers JetMove xxx by Jetter AG, the correct motor type must be set. The settings of the motor and resolver pole numbers will then be correct automatically.

- Put the drive into operation according to the operating manual of the servo amplifier.
- When using multi-axis systems, put each drive unit (*servo amplifier / motor*) into operation separately.

2.6 Notes on Safety as regards the Installation

HAZARD caused by high operating voltage!



Danger

Extremely hazardous voltages of up to DC 900 V may occur!

Please, observe the following precautions in order to avoid injuries such as muscle cramps, burns, unconsciousness, respiratory standstill or possibly death:

- Have installation and maintenance jobs carried out by qualified personnel only, see chapter 1.1.3 "Who is permitted to operate the JH3 servo motor?", page 10.
- Switch off the operating voltage.
- Please take into account the information on residual dangers given in chapter 1.3.2 "Hazards after POWER is turned OFF", page 15.
- Before carrying out installation and maintenance jobs, isolate the JH3 synchronous servo motor and all connected devices from the mains (pull out the mains plug).

2.7 Notes on Safety as regards Commissioning

HAZARD caused by high operating voltage!



Danger

Extremely hazardous voltages of up to DC 900 V may occur!

Please, observe the following precautions in order to avoid injuries such as muscle cramps, burns, unconsciousness, respiratory standstill or possibly death:

- Have commissioning jobs carried out by qualified personnel only, see chapter 1.1.3 "Who is permitted to operate the JH3 servo motor?", page 10.

Prior to commissioning, please do the following:

- Reattach the dismantled thermistor and check it for proper functioning.
- Reattach dismantled protective equipment and check it for proper functioning.
This way, protection from moving parts of the machine will be achieved.
- Protect the servo motor against accidental contact with live parts and components.
- Connect to the servo motor only devices or electrical components, e.g. resolver, HIPERFACE or servo motor, that have been sufficiently separated from the connected electric circuits.
- Always carry out each commissioning, even a short functional test, with correctly connected PE bus;

3 Operating Conditions

Operating Parameters	
Transport	
Temperature	-20 °C to 70 °C; maximum fluctuation: 20 °C per hour
Air humidity	Relative humidity up to 90 %, no condensation
Climatic Category	Category 2K4 to DIN EN 60721-3-2
Mounting in bearings	
Storage Temperature	-20 °C to 70 °C; maximum fluctuation: 20 °C per hour
Air humidity	Relative humidity up to 90 %, no condensation
Climatic Category	Category 1K4 to DIN EN 60721-3-1
Storage	Only in original packing in a dry, dust-free and non-vibrating room
Storage Period	No limitation
Operation at Rated Data to chapter 6 "Technical Data", page 31	
Ambient temperature	5 °C to 40 °C at an altitude of up to 1,000 m above sea level
Air humidity	Relative humidity 15 to 85 %, no condensation
Climatic Category	Category 3K4 to DIN EN 60721-3-3
Installation	<ul style="list-style-type: none"> • Horizontal position (B5) to Fig. 2 on Page 22 • If the module is operated at an altitude higher than 1,000 m above sea level, derating will be required. • A clearance of at least 10 cm above and below the motor must be maintained to provide proper air circulation.
Derating (currents and torques)	<ul style="list-style-type: none"> • 1 % per °C in the range of 40 °C to 50 °C up to 1,000 m above sea level • At altitudes higher than 1,000 m above sea level and 40 °C: <ul style="list-style-type: none"> 6 % at 2,000 m above sea level; 17 % at 3,000 m above sea level; 30 % at 4,000 m above sea level; 55 % at 5,000 m above sea level; • At altitudes higher than 1,000 m above sea level and a temperature reduction of 10 °C per 1,000 m no derating is required.
Maximum permissible flange temperature	65 °C + 10 %
Class of Protection	IP 65
Insulation Class	F acc. to VDE 0530
EMC	
Electro-Magnetic Compatibility	<p>EMC is ensured if the following requirements as to filtering and shielding are fulfilled: (cf. chapter 1.4 "Instructions on EMI", page 15)</p> <ul style="list-style-type: none"> • Emitted interference to DIN EN 50081-1 and DIN EN 50082-2 • Immunity to DIN EN 50082-2

4 Type Designation

	JH	3	-	0190	-	42	-	4	R	V	B	P	M	S	C	F	X
Motor type JH																	
Frame size 3																	
Continuous stall torque in Ncm																	
Back EMF constant in V/kRPM																	
Thermostatic circuit-breaker 4 = Overtemperature protection PTC *) 6 = KTY83-110																	
Shaft tolerances R - Concentricity tolerance of the shaft ends to DIN 42955R *)																	
Class of Protection V - Degree of protection IP65 without shaft seal *) V2 = Degree of protection IP65 with shaft seal																	
B - Brake _ = No brake *) B = brake DC 24 V																	
P - Shaft _ = Plain shaft *) P = Feather key to DIN 6885																	
M - Winding insulation _ = Winding for U_{DC} = 560 V *)																	
S - Electric connection _ = Vertical position of the connector *) S-A = Horizontal position of the connector in the direction of the motor shaft S-B = Horizontal position of the connector against the direction of the motor shaft S-X = Horizontal position of the connector; rotatable																	
C- Connector type _ = Encoder connector of the RC series and motor connector of the SC series for JH3 through JH5 motors *)																	
F = Encoder type _ = Resolver 2-pin *) F2 = HIPERFACE (SKS36 for JH3 or SRS50 for JH3 through JH5 motors) F3 = HIPERFACE (SKM36 for JH3 or SRM50 for JH3 through JH5 motors)																	
Additional Options X - Other configuration (e. g. specific customer requirements) Has been specified further in the product description																	

*) If in an order no specifications have been made on optimum protection against overtemperature and on extras to be provided, the features marked by bold *) are a standard of the respective motor.

Ordering Instructions

- Mating connectors and feather keys have to be ordered separately.
- The JH3 series also includes motors equipped with HIPERFACE.

Selection Criteria

- Continuous stall torque M_o [Nm]
- Rated speed n_n [rpm]
- Rotor inertia of motor and load J [kgcm²]
- RMS torque (calculated) M_{rms} [Nm]

For calculating the required servo motors and servo amplifiers, both the static **and** the dynamic load have to be considered (acceleration and deceleration).

Word of Advice on Accessories

For the operation of synchronous servo motors, a motor cable, a resolver or HIPERFACE cable, a servo amplifier and possibly a speed reducer are required. Jetter AG employees would be glad to assist you in selecting the cables, the servo amplifier and a suitable speed reducer.

Word of Advice on the Holding Brake

As an alternative, there are motors with integrated holding brake available. The permanent magnet brake is controlled by DC 24 V; in de-energized condition, it will block the rotor.

The holding brakes have been designed as standstill brakes!

They are not approved for permanent slowing down the motor as a part of the operating mode!

5 Physical Dimensions

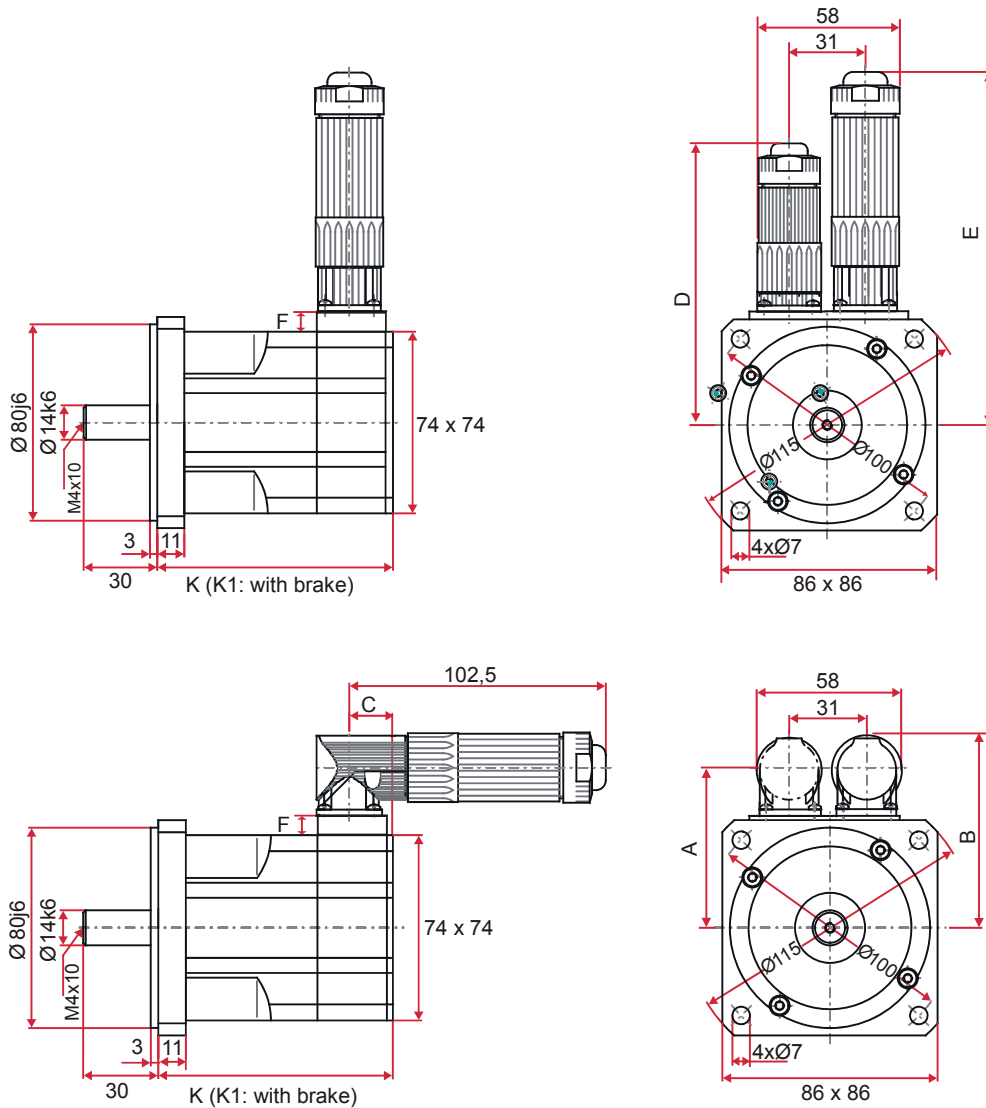

Motor with Resolver	K	K1	A	B	C	D	E	F
JH3-0095	96	138	56	70,3	18	105	134	0
JH3-0190	114	156	56	70,3	18	105	134	0
JH3-0320	150	192	56	70,3	18	105	134	0
JH3-0420	186	228	56	70,3	18	105	134	0

Motor with HIPERFACE	K	K1	A	B	C	D	E	F
JH3-0095	115,5	157,5	64	78	27,8	113	142	8
JH3-0190	133,5	175,5	64	78	27,8	113	142	8
JH3-0320	169,5	211,5	64	78	27,8	113	142	8
JH3-0420	205,5	247,5	64	78	27,8	113	142	8

Optional motor design with feather key to DIN 6885-A 5x5x22

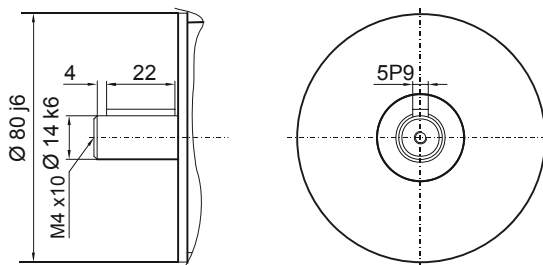

All dimensions in mm
The connectors of the option S-X are positioned 7 mm higher.

Fig. 4: Mounting dimensions of the JH3 motor series

6 Technical Data

Technical Data - JH3 Synchronous Servo Motor Series, Part 1					
Motor Type			JH3-0095-39	JH3-0190-42	JH3-0320-35
Motor Data					
Continuous Stall Torque	M_o	<i>Nm</i>	0.95	1.9	3.3
Continuous Stall Current	I_o	<i>A</i>	1.47	2.8	5.7
Back EMF Constant	K_E	<i>V/kRPM</i>	39	42	34.5
Torque Constant	K_T	<i>Nm/A</i>	0.65	0.69	0.57
Winding resistance: phase to phase	R_{Ph}	Ω	9.9	4	1.32
Winding inductance: phase to phase	L_{Ph}	<i>mH</i>	30.6	15.4	5.5
Electrical time constant	T_{el}	<i>ms</i>	3.1	3.9	4.2
Mechanical time constant	T_{mech}	<i>ms</i>	2.1	1	0.77
Thermal time constant	T_{ther}	<i>min</i>	25	30	33
Number of Motor Poles	p_{mot}	-	10	10	10
Number of Resolver Poles	p_{res}	-	2	2	2
Rated data ($U_{DC} = 320 V$) **)					
Rated Torque	M_n	<i>Nm</i>	0.86	1.6	2.6
Rated Speed	n_n	<i>RPM</i>	3,000	3,000	4,500
Continuous Rated Current	I_n	<i>A</i>	1.43	2.4	4.7
Rated data ($U_{DC} = 560 V$) **)					
Rated Torque	M_n	<i>Nm</i>	0.72	1.35	2.1
Rated Speed	n_n	<i>RPM</i>	5,000	5,000	6,000
Continuous Rated Current	I_n	<i>A</i>	1.24	2.1	3.98
Peak Values					
Peak Torque	M_{max}	<i>Nm</i>	2.4	5.2	9.5
Peak current	I_{max}	<i>A</i>	5.4	11.1	25
Peak Speed	n_{max}	<i>RPM</i>	12,000	12,000	12,000
Mechanical Parameters					
Rotor Inertia	J	<i>kg*cm²</i>	0.5	0.7	1.1
Weight without Brake	m	<i>kg</i>	1.5	2.1	3.2
Weight with Brake	m_{Br}	<i>kg</i>	2.1	2.7	3.8

Technical Data - JH3 Synchronous Servo Motor Series, Part 1					
Axial load ^{*)}	F_A	<i>N</i>	64	70	77
Radial load ^{*)}	F_R	<i>N</i>	335	368	406
Holding Brake for DC 24 V (optional)					
Holding Torque	M_{BR}	<i>Nm</i>	4.5		
Supply voltage	U_{BR}	<i>V</i>	DC 24 V (-10 % up to +6 %)		
Rated output	P_{BR}	<i>W</i>	12		
Rotor Inertia	J_{Br}	<i>kg*cm²</i>	0.18		
Other Technical Data					
Painting	Dull black, colour RAL 9005 (no stability to solvents, such as Trilene, thinners, etc.)				
Ball Bearing Service Life	20,000 operating hours				
Thermal Motor Protection	PTC resistor				

All specified current and voltage values are RMS values.

*) Maximum allowed radial or axial force at 3,000 RPM. **The axial force F_A must not become greater than a third of the radial force F_R.**

**) U_{DC} relates to the DC link voltage connected to a motor.

Technical Data - JH3 Synchronous Servo Motor Series, Part 2				
Motor Type			JH3-0320-46	JH3-0420-53
Motor Data				
Continuous Stall Torque	M_o	<i>Nm</i>	3.3	4.2
Continuous Stall Current	I_o	<i>A</i>	4.3	4.8
Back EMF Constant	K_E	<i>V/kRPM</i>	46	53
Torque Constant	K_T	<i>Nm/A</i>	0.76	0.88
Winding resistance: phase to phase	R_{Ph}	Ω	2.2	1.77
Winding inductance: phase to phase	L_{Ph}	<i>mH</i>	9.8	10
Electrical time constant	T_{el}	<i>ms</i>	4.5	5.7
Mechanical time constant	T_{mech}	<i>ms</i>	0.72	0.6
Thermal time constant	T_{ther}	<i>min</i>	33	36
Number of Motor Poles	p_{mot}	-	10	10
Number of Resolver Poles	p_{res}	-	2	2
Rated data (U_{DC} = 320 V **)				
Rated Torque	M_n	<i>Nm</i>	2.9	3.1
Rated Speed	n_n	<i>RPM</i>	3,000	3,000
Continuous Rated Current	I_n	<i>A</i>	4	3.7
Rated data (U_{DC} = 560 V **)				
Rated Torque	M_n	<i>Nm</i>	2.4	2.4
Rated Speed	n_n	<i>RPM</i>	5,000	5,000
Continuous Rated Current	I_n	<i>A</i>	3.35	2.98
Peak Values				
Peak Torque	M_{max}	<i>Nm</i>	9.5	12.3
Peak current	I_{max}	<i>A</i>	18.6	21
Peak Speed	n_{max}	<i>RPM</i>	12,000	12,000
Mechanical Parameters				
Rotor Inertia	J	<i>kg*cm²</i>	1.1	1.5
Weight without Brake	m	<i>kg</i>	3.2	4.4
Weight with Brake	m_{Br}	<i>kg</i>	3.8	4.9
Axial load *)	F_A	<i>N</i>	77	81
Radial load *)	F_R	<i>N</i>	406	427

Technical Data - JH3 Synchronous Servo Motor Series, Part 2			
Holding Brake for DC 24 V (optional)			
Holding Torque	M_{BR}	Nm	4.5
Supply voltage	U_{BR}	V	DC 24 V (-10 % up to +6 %)
Rated output	P_{BR}	W	12
Rotor Inertia	J_{Br}	kg*cm ²	0.18
Other Technical Data			
Painting	Dull black, colour RAL 9005 (no stability to solvents, such as Trilene, thinners, etc.)		
Ball Bearing Service Life	20,000 operating hours		
Thermal Motor Protection	PTC resistor		

All specified current and voltage values are RMS values.

*) Maximum allowed radial or axial force at 3,000 RPM. **The axial force F_A must not become greater than a third of the radial force F_R .**

**) U_{DC} relates to the DC link voltage connected to a motor.

Corner points



Abb. 5: Characteristic curve according to the JH3 synchronous servo motor series

Corner Points: Characteristics for JH3 Servo Motors				
Motor Type		JH3-0095-39	JH3-0190-42	JH3-0320-35
AC rated voltage U_n	<i>V</i>	190	190	190
Rated torque M_n	<i>Nm</i>	0.86	1.6	2.6
Rated speed n_n	<i>RPM</i>	3,000	3,000	4,500
Continuous stall torque M_o	<i>Nm</i>	0.95	1.9	3.3
Peak torque M_{max}	<i>Nm</i>	2.4	5.2	9.5
Peak torque M_x at n_n	<i>Nm</i>	1.6	3.3	4.4
Idling speed n_o	<i>RPM</i>	5,080	4,800	5,780
Limit speed n_z at $I_{max} + M_z$	<i>RPM</i>	1,730	1,750	2,240
Limit torque M_z at $I_{max} + n_z$	<i>Nm</i>	2.4	5.1	9.4

Corner Points: Characteristics for JH3 Servo Motors			
Motor Type		JH3-0320-46	JH3-0420-53
AC rated voltage U_n	<i>V</i>	190	190
Rated torque M_n	<i>Nm</i>	2.9	3.1
Rated speed n_n	<i>RPM</i>	3,000	3,000
Continuous stall torque M_o	<i>Nm</i>	3.3	4.2
Peak torque M_{max}	<i>Nm</i>	9.5	12.3
Peak torque M_x at n_n	<i>Nm</i>	5.2	5.4
Idling speed n_o	<i>RPM</i>	4,340	3,760
Limit speed n_z at $I_{max} + M_z$	<i>RPM</i>	1,610	1,450
Limit torque M_z at $I_{max} + n_z$	<i>Nm</i>	9.4	12.2

7 Description of Connections

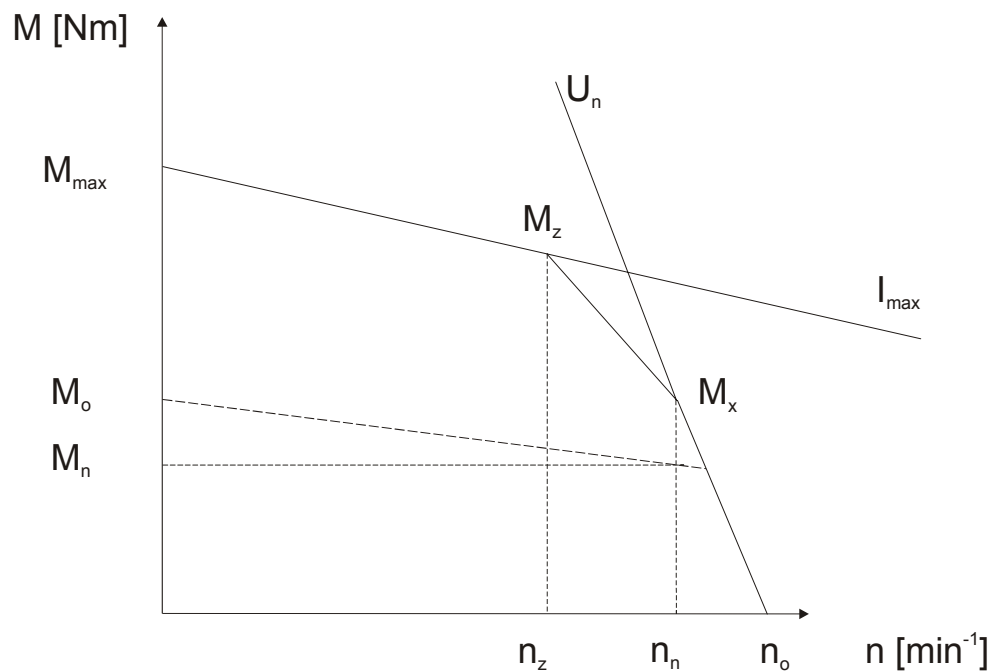
7.1 Motor Connection by means of the Motor Connector Series SC

7.1.1 General remarks



Important!

Alternative measures to avoid malfunctions of the control system and the motor:



Operate the brake via a separately shielded brake line. The distance between brake line and motor power cable should be greater than 20 cm. This is the preferred solution.



Always connect brake lines to a separate power supply unit DC 24 V if brake and motor lines are run together in one bunch of cables, and are not separately shielded.



Important!

Measures to avoid oscillation and blocking of the motor:



Avoid mixing-up of phase conductors, resp. be sure to connect the phase conductors according to pin assignment.

7.1.2 Motor power cable with mating connector



Note!

The suitable mating connector (female connector) of the synchronous servo motor series JH3 can be ordered from Jetter AG by supplying the following particulars:

- Article # 15100070 Motor connector JL2-JL4/JK4-JK6 without brake
- Article # 15100105 Motor connector JL2-JL4/JK4-JK6 with brake



Note!

The Jetter Motor power cable of the synchronous servomotor series JH3 can be purchased from Jetter AG. It is confectioned with the matching motor connector and can be ordered by the following cable confection numbers:

Without Brake:

- Cable confection # 26.1 For JetMove 203 and JetMove 206
- Cable confection # 26.1 For JetMove 601 through 610

With Brake:

- Cable confection # 24.1 For JetMove 203 and JetMove 206
- Cable confection # 24.1 For JetMove 601 through 610

Mating connector of the motor (solder side)

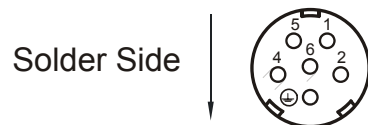
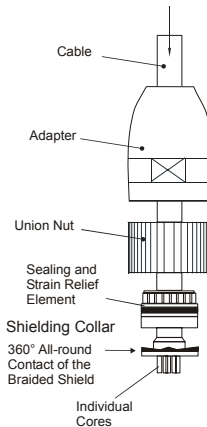
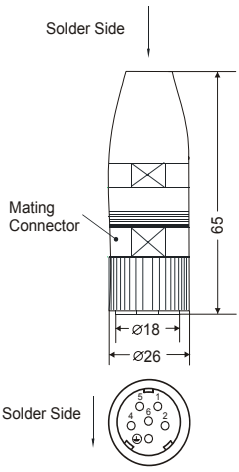
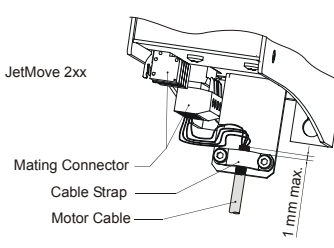



Fig. 6: View on the SC series mating connector of the motor (internal thread M23)

7.1.3 Motor power cable for JetMove 2xx

Motor power cable - Cable confection # 26.1			
Connecting terminals of JetMove 2xx	Shield		Mating connector of the motor (female, solder side)
<p>4 x 1.5 mm² The wires are equipped with wire end ferrules.</p>	<p>Shielded, highly flexible 4-wire cable with PE.</p> 		
		<p>Connect both sides of the shield with the greatest possible surface area! Use metallized housing only!</p>	
Pin	Wire Number	Signal	Pin
X62.U2	1	Phase 1	1
X62.V2	2	Phase 2	5
X62.W2	3	Phase 3	2
X62.PE	Yellow-green	PE conductor	

All dimensions in millimeters.

Motor power cable - Cable confection # 24.1			
Connecting terminals of JetMove 2xx	Shield		Mating connector of the motor (female, solder side)
<p>7 x 1.5 mm²</p> <p>The wires are equipped with wire end ferrules.</p>	<p>Shielded, highly flexible 6-wire cable with PE.</p>		
<p>Connect both sides of the shield with the greatest possible surface area!</p> <p>Use metallized housing only!</p>			
Pin	Wire Number	Signal	Pin
X62.U2	1	Phase 1	1
X62.V2	2	Phase 2	5
X62.W2	3	Phase 3	2
X62.PE	Yellow-green	PE conductor	
X10.BRAKE2	5	Brake +	6
X10.GND	4	Brake -	4

All dimensions in millimeters.

7.1.4 Motor power cable for JetMove 6xx

Motor power cable - Cable confection # 26.1			
Connecting Terminals of JetMove 601 through JetMove 610	Shield		Mating connector of the motor (female, solder side)
<p>4 x 1.5 mm²</p> <p>The wires are equipped with wire end ferrules.</p>	<p>Shielded, highly flexible 4-wire cable with PE.</p> <p>The shield is connected with the servo amplifier via PE.</p>		
	<p>Connect shield with the greatest possible surface area! Use metallized housing only!</p>		
Pin	Wire Number	Signal	Pin
X9.U2	1	Phase 1	1
X9.V2	2	Phase 2	5
X9.W2	3	Phase 3	2
X9.PE	Yellow-green	PE conductor	

All dimensions in millimeters.

Motor power cable - Cable confection # 24.1			
Connecting Terminals of JetMove 601 through JetMove 610	Shield		Mating connector of the motor (female, solder side)
<p>7 x 1.5 mm²</p> <p>The wires are equipped with wire end ferrules.</p>	<p>Shielded, highly flexible 6-wire cable with PE.</p> <p>The shield is connected with the servo amplifier via PE.</p>		
	<p>Connect shield with the greatest possible surface area! Use metallized housing only!</p>		
Pin	Wire Number	Signal	Pin
X9.U2	1	Phase 1	1
X9.V2	2	Phase 2	5
X9.W2	3	Phase 3	2
X9.PE	Yellow-green	PE conductor	
X9.Brake+	5	Brake +	6
X9.Brake-	4	Brake -	4

All dimensions in millimeters.

7.1.5 Connection assignment of terminal box

Connection Assignment of Terminal Box ^{*)}		
Connection Terminals of the Amplifier	Motor Terminal Box - Terminal Assignment	
U2	Pin 1	Phase 1
V2	Pin 2	Phase 2
W2	Pin 3	Phase 3
PE	Pin 4	 Protective earth
	Pin 7	Brake +
	Pin 8	Brake -

^{*)} alternatively to motor connectors

7.2 Connection of the Resolver

7.2.1 Motor power cable with mating connector



Note!

The resolver respectively HIPERFACE mating connector of the synchronous servo motor series JH3 can be ordered from Jetter AG by supplying the following particulars:

Article # 15100069 Resolver / HIPERFACE

The complete resolver cable connecting the servo amplifier series JetMove 2xx, respectively JetMove 6xx and the synchronous servo motor series JH3 can be ordered from Jetter AG.

It can be ordered by supplying the following cable confection number:

Cable confection # 23 For the servo amplifier series JetMove 2xx

Cable confection # 423 For the servo amplifier series JetMove 6xx

In case you prefer to fabricate the cables yourself, the following minimum requirements must be met, also considering EMC:

- Max. cable length: 50 m
- Cable size: $3 \times 2 \times 0.14 \text{ mm}^2 + 2 \times 0.5 \text{ mm}^2$;
 $2 \times 0.5 \text{ mm}^2$ must be used for the thermal sensor.
- Twisted-pair cables with all-over shield must be used.
- The shield must be connected to the connector housings on both ends of the cable with the greatest possible surface area.

Mating connector of the resolver (solder side)



Fig. 7: RC series mating connector of the resolver (internal thread M23)

7.2.2 Resolver cable for JetMove 2xx

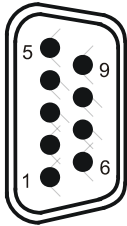
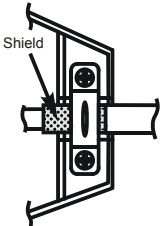
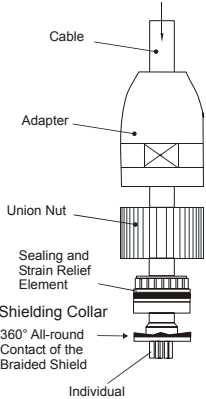
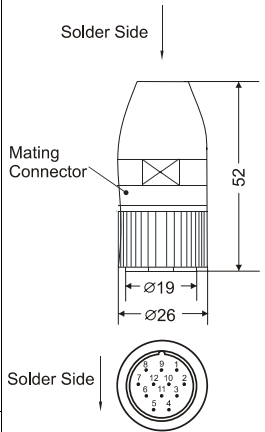
Resolver cable of cable confection # 23			
JetMove 2xx (SUB-D connector X61)	Shield		Motor (Resolver) (female, solder side)
 <p>Attaching screws must have a metric thread!</p>			
	<p>Connect shield with the greatest possible surface area! Use metallized housing only!</p>		
Pin	Signal	Core Colour	Pin
8	S1 (cosine +)	red	1
3	S3 (cosine -)	blue	2
2	S4 (sine -)	yellow	3
7	S2 (sine +)	green	4
1	R1R (exciter winding +)	pink	5
6	R2L (exciter winding -)	gray	6
9	Th1 (thermal sensor)	white	7
4	Th2 (thermal sensor)	brown	8
-	Unassigned	-	9 - 12

All dimensions in millimeters.

7.2.3 Resolver cable for JetMove 6xx

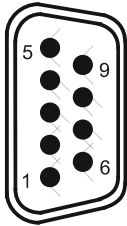
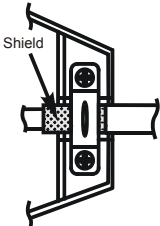
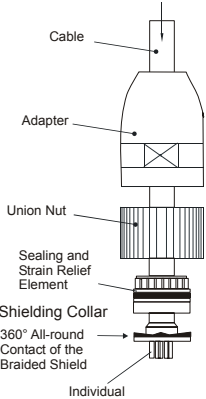
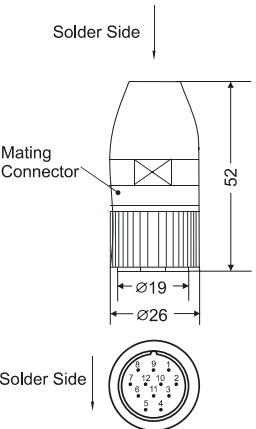
Resolver cable of cable confection # 423			
JetMove 6xx (SUB-D connector X2)	Shield		Motor (Resolver) (female, solder side)
 <p>Attaching screws must have an inch thread!</p>			
	<p>Connect shield with the greatest possible surface area! Use metallized housing only!</p>		
Pin	Signal	Core Colour	Pin
4	S1 (cosine -)	red	1
8	S3 (cosine +)	blue	2
7	S4 (sine -)	yellow	3
3	S2 (sine +)	green	4
5	R1R (R +)	pink	5
9	R2L (R -)	gray	6
2	Th1 (thermal sensor)	white	7
6	Th2 (thermal sensor)	brown	8
-	Unassigned	-	9 - 12

All dimensions in millimeters.

7.3 HIPERFACE connection

7.3.1 HIPERFACE cable with mating connector



Note!

The resolver respectively HIPERFACE mating connector of the synchronous servo motor series JH3 can be ordered from Jetter AG by supplying the following particulars:

Article # 15100069 Resolver / HIPERFACE

The complete HIPERFACE cable connecting the servo amplifier series JetMove 2xx, respectively JetMove 6xx and the synchronous servo motor series JH3 can be ordered from Jetter AG.

It can be ordered by supplying the following cable confection number:

Cable confection # 723 For the servo amplifier series JetMove 2xx

Cable confection # 523 For the servo amplifier series JetMove 6xx

In case you prefer to fabricate the cables yourself, the following minimum requirements must be met, also considering EMC:

- Max. cable length: 50 m
- Cable size: 5 x 2 x 0.25 mm²
- Twisted-pair cables with outer shield must be used; the signal lines must also be twisted in pairs:
 - Sine + and reference sine
 - Cosine + and reference cosine
 - DATA - and DATA +
 - 0 V and voltage supply
 - thermal sensor
- The shield must be connected to the connector housings on both ends of the cable with the greatest possible surface area.

HIPERFACE mating connector (solder side)

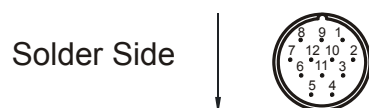
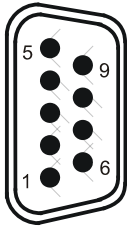
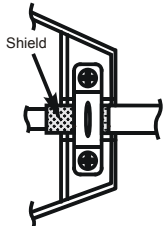
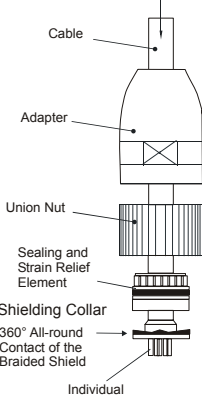
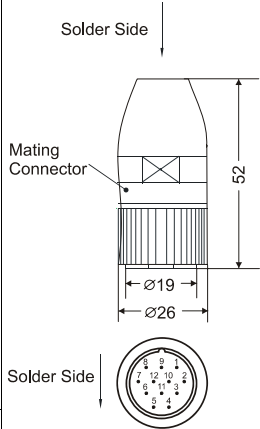



Fig. 8: RC series HIPERFACE mating connector (internal thread M23)

7.3.2 HIPERFACE cable for JetMove 2xx

HIPERFACE cable of cable confection # 723			
JetMove 2xx (SUB-D connector X61)	Shield		Motor (HIPERFACE) (female, solder side)
 <p>Attaching screws must have a metric thread!</p>			
		<p>Connect shield with the greatest possible surface area! Use metallized housing only!</p>	
Pin	Signal	Core Colour	Pin
-	Unassigned	-	1
-	Unassigned	-	2
7	Sine +	white	3
2	Reference sine	brown	4
8	Cosine +	green	5
3	Reference cosine	yellow	6
6	DATA - (RS-485)	gray	7
1	DATA + (RS-485)	pink	8
4	0 V	blue	9 *)
5	Power Supply (7 - 12 volts)	red	10
9	Thermal sensor	black	11
	Thermal sensor	-	12 *)

*) Pin 9 and pin 12 are short-circuited
All dimensions in millimeters.

7.3.3 HIPERFACE cable for JetMove 6xx

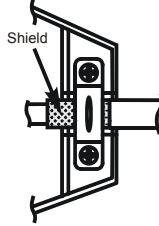
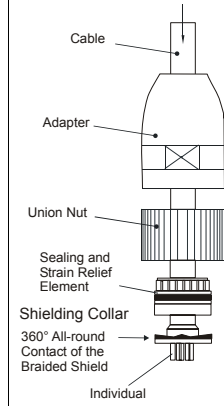
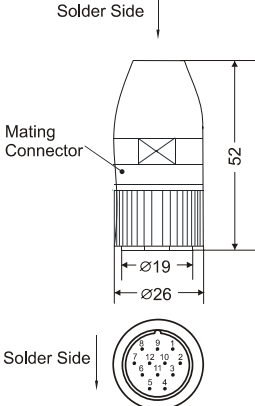
HIPERFACE cable of cable confection # 523			
JetMove 6xx (SUB-D connector X1)	Shield		Motor (HIPERFACE) (female, solder side)
 <p>Attaching screws must have an inch thread!</p>			
	<p>Connect shield with the greatest possible surface area! Use metallized housing only!</p>		
Pin	Signal	Core Colour	Pin
-	Unassigned	-	1
-	Unassigned	-	2
1	Sine +	white	3
9	Reference sine	brown	4
3	Cosine +	green	5
11	Reference cosine	yellow	6
13	DATA - (RS-485)	gray	7
5	DATA + (RS-485)	pink	8
2	0 V	blue	9
4	Power Supply (7 - 12 volts)	red	10
14	Thermal sensor	black	11
7	Thermal sensor	violet	12

All dimensions in millimeters.

8 Maintaining the Motor

Motor maintenance is limited to the following work: Exchanging ball bearings and occasionally cleaning the housing if it is very dirty.



Check the motor every 2,500 operating hours or at least once a year for unusual ball bearing noises.

If there are unusual noises stemming from the ball bearings:



Put the motor out of operation and send it to Jetter AG for being checked.

Do by no means disassemble the motor, as for reassembling, there are specific instructions and settings to be observed.

The ball bearings are equipped with a grease packing adequate for 20,000 service hours under normal operating conditions.



After these 20,000 service hours, the ball bearings must be replaced. For this, please send them to our company.



If there are unusual noises stemming from the motor (not the ball bearings), the motor must be put out of operation and checked.



Use isopropanol or a similar cleaning agent for cleaning the motor frame.

Do not use cleaning agents which contain solvents. On no account immerse the motor in diluent or spray it with diluent.

9 Troubleshooting

Table of Motor Faults		
Type of Error	Error Cause	Troubleshooting
Motor will not start	<ul style="list-style-type: none"> • Servo amplifier not enabled • Setpoint line interrupted • Motor phases mixed up • Brake not released • Drive blocked 	<ul style="list-style-type: none"> • Apply ENABLE signal • Check setpoint line • Connect motor phases correctly • Check brake control • Check drive mechanism
Motor overspeed	<ul style="list-style-type: none"> • Motor phases mixed up 	<ul style="list-style-type: none"> • Connect motor phases correctly
Motor chatters	<ul style="list-style-type: none"> • Resolver line shielding interrupted • Gain factor too high 	<ul style="list-style-type: none"> • Replace resolver line • Use motor default values
Error message: Brake	<ul style="list-style-type: none"> • Short-circuit in the supply line of the motor holding brake • Motor holding brake defective 	<ul style="list-style-type: none"> • Eliminate short circuit • Replace motor
Error message: Output stage	<ul style="list-style-type: none"> • Short-circuit or ground fault on motor line • Short-circuit or ground fault in motor 	<ul style="list-style-type: none"> • Replace cable • Replace motor
Error message: Resolver	<ul style="list-style-type: none"> • Resolver connector has not been plugged on properly • Resolver line interrupted, crushed and the like 	<ul style="list-style-type: none"> • Check plug connection • Check the lines
Error message: Motor temperature	<ul style="list-style-type: none"> • Motor overtemperature protection tripped • Resolver line loose or interrupted 	<ul style="list-style-type: none"> • Wait until the motor has cooled off. Then, check cause. • Check connector, possibly replace resolver line
Brake does not grip	<ul style="list-style-type: none"> • Required holding torque is too high • Brake defective • Axial motor shaft overload 	<ul style="list-style-type: none"> • Check dimensioning • Replace motor • Possibly replace motor if bearings are defective.

Appendices

Appendix A: Recent Revisions

Chapter	Comment	Revised	Added	Deleted
Introduction	Description of Symbols Symbol with caption DANGER		✓	
Chapter 1 Safety Instructions	Symbol caption adjusted to degree of possible harm	✓		
Chapter 2.6 and 2.7 Installation	Symbol caption adjusted to degree of possible harm	✓		
Chapter 6	Rated data are from now on specified in relation to U_{DC} Technical Data Brake trip point	✓		✓

Appendix B: Glossary

AC	Alternating Current
CE	Communautés Européennes = European Union
Continuous rated current I_n	At a rated speed n_n and at output of the nominal torque, the motor will collect the continuous rated current. This parameter refers to the sine-effective current value.
Continuous stall current I_o	In order to supply the continuous stall torque during standstill, the motor will consume the continuous stall current. This parameter refers to the sine-effective current value.
Continuous stall torque M_o	Thermal limit torque which can be output for any length of time at standstill of the motor ($n = 0$ rev/min) and the set ambient conditions.
DC	Direct Current
DC link	DC circuit within a servo drive on the basis of which the motor currents are generated. Also known as DC bus.
DIN	DIN Deutsches Institut für Normung e.V. [= German Institute for Standardizing]
Drive Output Element	e.g. clutch, gear drive, pulley
EC Low Voltage Directive	To be considered when using electric devices of a rated voltage between 50 and 1,000 V AC and between 75 and 1,500 V DC.
Electro-Magnetic Compatibility (EMC)	Definition according to the EMC regulations: "EMC is the ability of a device to function in a satisfactory way in an electro-magnetic environment without causing electromagnetic disturbances itself, which would be unbearable for other devices in this environment."
EN	European Standard
EU	European Union
Hazard analysis	Excerpt from the Machinery Directive 98/37/EC: The manufacturer is under an obligation to assess the hazards in order to identify all of those which apply to his machine; he must then design and construct it taking account of his assessment.
HIPERFACE	High Performance Interface HIPERFACE designates a sensor-transducer system by Sick / Stegmann. The SinCos motor feedback system with the standardised HIPERFACE interface is often used in digital drive technology. Unlike the resolver, the SinCos motor feedback system with HIPERFACE inter-face contains electronic components. Over several motor rotations, a HIPERFACE will report the absolute position values; this cannot be performed by a resolver. A HIPERFACE is far more precise than a resolver, but also more expensive.

IP	International Protection
JetMove	<p>JetMove is the product designation of a digital servo amplifier series produced by Jetter AG, e.g. JetMove 206-230 with the following features:</p> <ul style="list-style-type: none"> – 206 identifies a rated current of 6 A; – 230 identifies the operating voltage of the rated power supply
JetWeb	Control technology comprising control systems, motion systems, user interfaces, visualization devices, remote I/Os and industrial PCs. Programming by means of multitasking and a modern sequence-oriented language. Communication by means of Ethernet TCP/IP and making use of the Web technologies.
Motor circuit-breaker	A circuit-breaker with monitoring functions as to phases and temperature of a motor.
PE	"Protective Earth", resp. "Protective Earth Conductor"
Peak current I_{\max}	<p>Permitted peak current for 5 s max.!</p> <p>The peak current should not exceed 3.5 times the value of the continuous rated current.</p>
Rated torque M_N	When the motor collects its rated current at a rated speed of n_n , the rated torque can be supplied for an unlimited time in operating mode S1.
Resolver	<p>Feedback unit at a servo motor for determining the absolute position within one revolution. Other than a HIPERFACE, the resolver will not provide any information on how many revolutions the motor has performed so far.</p> <p>A resolver could be envisaged as a transformer; the couplings of its secondary windings (sine and cosine) change in relation to the position of the motor shaft. Basically, a resolver consists of a rotor with one coil and a stator with two coils. The stator windings are displaced by 90° (sine and cosine). The resolver itself does not contain any electronic components.</p> <p>This resolver-converter uses a 12 bit resolution. One revolution of the shaft is regarded as a circle, which is divided into 4.096 increments.</p>
Rotor inertia J	Also known as mass moment of inertia. The rotor inertia is a mechanical parameter for rotating bodies. The greater the rotor inertia, the greater is the torque needed to accelerate the body up to the desired speed. The rotor inertia of a motor is the sum resulting from the mass moment of inertia of the rotor and of the resolver. Internal or external accessories (holding brake, encoder, clutch) or a load may affect the parameters specified in this manual. Therefore, for calculating the dynamic motor situation the rotor inertia in its entirety has to be taken into account.

SELV	<p>Safe Extra Low Voltage: Voltage, which, under all operating conditions will not exceed a peak or DC voltage of 42.4 V. This voltage is either measured between two conductors or between one conductor and earth. The circuit, in which this voltage occurs, must be separated from the mains power supply by a safety isolating transformer or some equivalent.</p>
Torque constant K_T	<p>This constant specifies the amount of torque [Nm] that is output by the motor at an RMS current of 1 A. $M = I * K_T$</p>
VDE	<p>Verband deutscher Elektrotechniker e.V. = Association of German Electrical Engineers</p>
Voltage constant K_E	<p>This constant specifies the induced electro-magnetic force of the motor related to 1,000 rev/min as an RMS value between two motor phases.</p>

Units:

Ω	Ohm
$^{\circ}$	Degrees (angular dimension)
$^{\circ}\text{C}$	Degrees centigrade (temperature unit)
A	Ampere
cm	Centimeter (1 cm = 10^{-2} m)
cm^2	Square centimeter
H	Henry
kg	Kilogram
m	Meter
mH	Millihenry (1 mH = 10^{-3} H)
min	Minute
N	Newton
Nm	Newtonmeter
W	Watt
Ω	Ohm
$^{\circ}\text{C}$	Degrees centigrade (temperature unit)
$^{\circ}$	Degrees (angular dimension)

Appendix C: List of Illustrations

Fig. 1:	Example: Fitting a power output element	21
Fig. 2:	Mounting Positions of JH3 Motors	22
Fig. 3:	Removing a power output element	23
Fig. 4:	Mounting dimensions of the JH3 motor series	30
Fig. 5:	Characteristic curve according to the JH3 synchronous servo motor series	34
Fig. 6:	View on the SC series mating connector of the motor (internal thread M23)	37
Fig. 7:	RC series mating connector of the resolver (internal thread M23)	43
Fig. 8:	RC series HIPERFACE mating connector (internal thread M23)	46

Appendix D: Index

A

Active forces	
axial	19
Radial	19
Ambient conditions	18

B

Ball bearing noises	49
Ball Bearing Service Life	32, 34
Belt drive	19
Blocking	36

C

Cable confection #	37, 43, 46
Checking the installation	24
Cleaning	49
Clutch	19, 21
Collets	21
Corrosion damages	21

D

Damages in transit and storage	21
Description of Symbols	5
Disposal	11

E

Earthing procedure	12
Electrical Installation	23

F

Fitting the power output element	19,
21	
Flange temperature	19

H

HIPERFACE cable	
JetMove 2xx	
Cable confection # 723	47
JetMove 6xx	
Cable confection # 523	48

I

Information Signs	12
Installation location	22
Installation to EMC rules	16

L

Laying lines	23
--------------	----

M

Maintenance	11
Malfunctions	12, 36
Mechanical Installation	21
Mode of installation	22
Modifications	10
Motor cable size	23
Motor Power Cable	
JetMove 2xx	
Cable confection # 24.1	39
Cable confection # 26.1	38
JetMove 6xx	
Cable confection # 24.1	41
Cable confection # 26.1	40
Motor shaft	
avoid hard blows	19
Mounting in bearings	22
Mounting and Startup Accessories	17

N

Noise immunity	15
----------------	----

O

Operating Parameters	27
Ordering Instructions	29
Oscillation	36

P

Pulling Device	22
----------------	----

Q

Qualified Staff	10
-----------------	----

R

Repair	10
Replacing the ball bearings	49
Residual Dangers	
Electric shock	15, 25, 26
Explosive gas atmosphere	14
High operating voltage	13
Hot surface	13
Mech. force	14
Resolver cable	
JetMove 2xx	
Cable confection # 23	44
JetMove 6xx	
Cable confection # 423	45

S

Scope of Delivery	17
-------------------	----

T

Table of Motor Faults	50
Terminal box	42
Thermistor	9, 19

U

Usage as agreed upon	9
Usage Other Than Agreed Upon	10

W

Word of Advice on Accessories	29
Word of advice on the holding brake	29



Jetter AG

Gräterstraße 2
D-71642 Ludwigsburg

Germany

Phone: +49 7141 2550-0
Phone -
Sales: +49 7141 2550-433
Telefax
Sales: +49 7141 2550-484
Hotline: +49 7141 2550-444
Internet: <http://www.jetter.de>
E-Mail: sales@jetter.de

Jetter Subsidiaries

Jetter Asia Pte. Ltd.

32 Ang Mo Kio Industrial Park 2
#05-02 Sing Industrial Complex
Singapore 569510

Singapore

Phone: +65 6483 8200
Fax: +65 6483 3881
E-Mail: sales@jetter.com.sg
Internet: <http://www.jetter.com.sg>

Jetter (Schweiz) AG

Münchwilerstraße 19
CH-9554 Tägerchen

Switzerland

Phone: +41 719 1879-50
Fax: +41 719 1879-69
E-Mail: info@jetterag.ch
Internet: <http://www.jetterag.ch>

Jetter USA Inc.

165 Ken Mar Industrial Parkway
Broadview Heights
OH 44147-2950

U.S.A.

Phone: +1 440 8380860
Fax: +1 440 8380861
E-Mail: bschulze@jetterus.com
Internet: <http://www.jetterus.com>