



YASKAWA

YASKAWA AC Drive Option LED Operator Installation Manual

Type JVOP-182

To properly use the product, read this manual thoroughly and retain for easy reference, inspection, and maintenance. Ensure the end user receives this manual.

安川インバータ オプション LEDオペレータ 取扱説明書

形式 JVOP-182

製品を安全にお使い頂くために、この取扱説明書を必ずお読みください。
また、本書をお手元に保管していただくとともに、最終的に本製品をご使用になるユーザー様のお手元に確実に届けられるよう、お取り計らい願います。

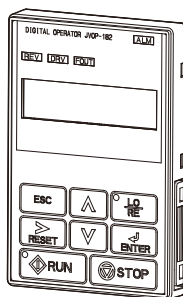



Table of Contents

1 PREFACE AND SAFETY	4
2 PRODUCT OVERVIEW	8
3 RECEIVING	9
4 LED OPERATOR OPTION COMPONENTS	11
5 INSTALLATION PROCEDURE	16
6 BASIC OPERATION	22
7 RELATED PARAMETERS	24
8 LED OPERATOR OPTION FAULT DIAGNOSTICS	26
9 SPECIFICATIONS	28
10 REVISION HISTORY	29

Copyright © 2008 YASKAWA ELECTRIC CORPORATION

All rights reserved. No part of this publication may be reproduced, stored in a retrieval system, or transmitted, in any form or by any means, mechanical, electronic, photocopying, recording, or otherwise, without the prior written permission of Yaskawa. No patent liability is assumed with respect to the use of the information contained herein. Moreover, because Yaskawa is constantly striving to improve its high-quality products, the information contained in this manual is subject to change without notice. Every precaution has been taken in the preparation of this manual. Yaskawa assumes no responsibility for errors or omissions. Neither is any liability assumed for damages resulting from the use of the information contained in this publication.

1 Preface and Safety

Yaskawa manufactures products used as components in a wide variety of industrial systems and equipment. The selection and application of Yaskawa products remain the responsibility of the equipment manufacturer or end user. Yaskawa accepts no responsibility for the way its products are incorporated into the final system design. Under no circumstances should any Yaskawa product be incorporated into any product or design as the exclusive or sole safety control. Without exception, all controls should be designed to detect faults dynamically and fail safely under all circumstances. All systems or equipment designed to incorporate a product manufactured by Yaskawa must be supplied to the end user with appropriate warnings and instructions as to the safe use and operation of that part. Any warnings provided by Yaskawa must be promptly provided to the end user. Yaskawa offers an express warranty only as to the quality of its products in conforming to standards and specifications published in the Yaskawa manual. **NO OTHER WARRANTY, EXPRESSED OR IMPLIED, IS OFFERED.** Yaskawa assumes no liability for any personal injury, property damage, losses, or claims arising from misapplication of its products.

◆ Applicable Documentation

The following manuals are available for the JVOP-182 LED Operator Option:

LED Operator

	<p style="text-align: center;">Yaskawa AC Drive Option LED Operator Installation Manual</p> <p>Read this manual first. The installation manual is packaged with the LED Operator Option and contains a basic overview of wiring, settings, functions, and fault diagnoses.</p>
---	---

RS-232C Interface Option

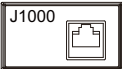
	<p style="text-align: center;">Yaskawa AC Drive -RS-232C Interface Option Technical Manual</p> <p>The Technical Manual is packaged with the RS-232C Interface Option and contains a basic overview of wiring, settings, functions, and fault diagnoses.</p>
---	--

For the drive setup, refer to the drive Quick Start Guide or Technical Manual.

Yaskawa Drive

	<p>Refer to the manual of the drive this option is being used with. The manual for the drive covers basic installation, wiring, operation procedures, functions, troubleshooting, and maintenance information. It also includes important information on parameter settings and how to tune the drive. To obtain instruction manuals for Yaskawa products access these sites: Europe: http://www.yaskawa.eu.com Japan: http://www.e-mechatronics.com Other areas: contact a Yaskawa representative.</p>
--	--

1 Preface and Safety

◆ Terms

Note:	Indicates a supplement or precaution that does not cause drive damage.
≥ 1010:	Indicates a drive feature or function that is only available in drive software version 1010 or greater.
LED:	Light emitting diode.

◆ Registered Trademarks

Company names and product names listed in this manual are the registered trademarks of those companies.

◆ Supplemental Safety Information

Read and understand this manual before installing, operating or servicing this option unit. The option unit must be installed according to this manual and local codes.

The following conventions are used to indicate safety messages in this manual. Failure to heed these messages could result in serious or possibly even fatal injury or damage to the products or to related equipment and systems.

DANGER

Indicates a hazardous situation, which, if not avoided, will result in death or serious injury.

WARNING

Indicates a hazardous situation, which, if not avoided, could result in death or serious injury.

CAUTION

Indicates a hazardous situation, which, if not avoided, could result in minor or moderate injury.

NOTICE

Indicates an equipment damage message.

■ General Safety

General Precautions

- The diagrams in this section may include option units and drives without covers or safety shields to illustrate details. Be sure to reinstall covers or shields before operating any devices. The option board should be used according to the instructions described in this manual.
- Any illustrations, photographs, or examples used in this manual are provided as examples only and may not apply to all products to which this manual is applicable.
- The products and specifications described in this manual or the content and presentation of the manual may be changed without notice to improve the product and/or the manual.
- When ordering a new copy of the manual due to damage or loss, contact your Yaskawa representative or the nearest Yaskawa sales office and provide the manual number shown on the front cover.

DANGER

Heed the safety messages in this manual.

Failure to comply will result in death or serious injury.

The operating company is responsible for any injuries or equipment damage resulting from failure to heed the warnings in this manual.

NOTICE

Do not expose the drive to halogen group disinfectants.

Failure to comply may cause damage to the electrical components in the option unit.

Do not pack the drive in wooden materials that have been fumigated or sterilized.

Do not sterilize the entire package after the product is packed.

2 Product Overview

◆ About This Product

The LED Operator Option provides an enhanced drive user interface that can operate the Yaskawa drive at a short distance up to 3 meters. The LED Operator Option is an LED display that simplifies the task of interfacing with the drive to perform these tasks:

- Read or modify drive parameters.
- Read and copy drive parameter settings to another Yaskawa drive.
- Operate the drive.
- Monitor drive operation status.

All keys except for the STOP key on the drives built-in LED operator will not function when the LED Operator Option is connected to V1000 and J1000. <I>

<I> If desired, to also disable the STOP key on the drives built-in LED operator, set parameter o2-02 (STOP Key Function Selection) to 0 (Disabled).

◆ Applicable Models

The LED Operator Option can be used with the drive models in [Table 1](#).

Table 1 Applicable Drive Models

Drive	Drive Software Version <I>
A1000	≥ 1010
J1000	≥ 1010
V1000	≥ 1016

<I> See "PRG" on the drive nameplate for software version number.

3 Receiving

Perform the following tasks after receiving the LED Operator Option:

- Inspect the LED Operator Option for damage.
If the LED Operator Option appears damaged upon receipt, contact the shipper immediately.
- Verify receipt of the correct model by checking the model number printed on the Name plate of the LED Operator Option.
- If you have received the wrong model or the LED Operator Option does not function properly, contact your supplier.

◆ Contents and Packaging

Table 2 Contents of Package

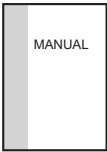
Description:	LED Operator Option	Installation Manual
—		
Quantity:	1	1

■ Additional Part Required (Sold Separately)



Proper installation of the LED Operator Option requires a communication cable. A communication cable is not provided. A connection cable can be purchased from Yaskawa or recommended LAN cables may be used. Refer to [Table 3](#) for more information regarding the cable required for your application.

Depending on the LED Operator Option installation method, an installation support listed in [Table 3](#) may also be required. [Refer to Installing the LED Operator Option on page 17](#) for more information regarding installation methods.

To order a cable or an installation support, contact Yaskawa directly or your nearest Yaskawa distributor.

3 Receiving

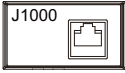
Table 3 Item Names and Part Numbers (Sold Separately)

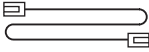
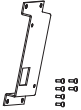
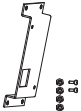
Item	Yaskawa Part Number	Notes	Page
 RS-232C Interface Option	SI-232/J	<3>	20
 Communication Cable (1 m)	WV001 <2>	Sold Separately	20
 Communication Cable (3 m)	WV003 <2>	Sold Separately	20
 Installation Support Set A	EZZ020642A	Sold Separately; For use with holes through the panel	18
 Installation Support Set B <1>	EZZ020642B	Sold Separately; For use with panel mounted threaded studs	19

<1> If weld studs are on the back of the panel, use the Installation Support Set B.

<2> Alternate cables (customer supplied), RJ45 8 pin Straight Connector UTP Cat 5e cable.

<3> To connect the LED operator to J1000, install the RS-232C Interface Option to the drive.

◆ Tool Requirements

To install the LED operator on the door of the enclosure panel, the following tools are required:

Table 4 Required Tools

Installation Location	Installation Support	Required Tools
External/Face Mount	–	Phillips screwdriver, M3
	Installation Set A	Phillips screwdriver, M3, M4
Internal/Flush Mount	Installation Set B	Phillips screwdriver, M3 Box end or adjustable wrench, M4

4 LED Operator Option Components

◆ LED Operator Option

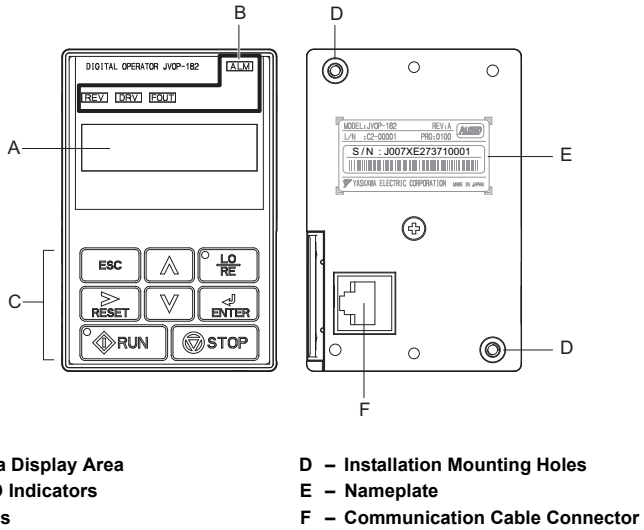

Figure 1 LED Operator Option Components

4 LED Operator Option Components

◆ Keys

Refer to [Figure 2](#) and [Table 5](#) for details on key names and functions.

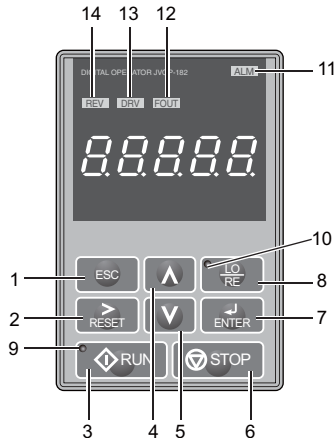















Figure 2 Keys

Table 5 Key Names and Functions

No.	Key	Name	Function
1		ESC Key	<ul style="list-style-type: none"> Returns to the previous display. Moves the cursor one space to the left. Pressing and holding this button will return to the Frequency Reference display.
2		RESET Key	<ul style="list-style-type: none"> Moves the cursor to the right. Resets the drive to clear a fault situation.
3		RUN Key	Starts the drive and motor.
4		Up Arrow Key	Scrolls up to display the next item, selects parameter numbers and increments setting values.

4 LED Operator Option Components



No.	Key	Name	Function
5		Down Arrow Key	Scrolls down to display the next item, selects parameter numbers and increments setting values.
6		STOP Key	Stops drive operation. Note: The STOP key can be enabled or disabled when operating from the external terminal or network communications by setting parameter o2-02.
7		ENTER Key	<ul style="list-style-type: none"> Enters parameter values and settings. Selects a menu item to move between displays.
8		LO/RE Selection Key	Switches the drive between operator (LOCAL) control and control circuit terminals (REMOTE). Note: The LOCAL/REMOTE key is only effective at a stop in drive mode. As a safety precaution, it is possible to disable the LO/RE Selection Key by setting parameter o2-01 (LOCAL/REMOTE Key Function Selection) to "0" (disabled). <1>
9		RUN Light	Illuminated while the drive is operating the motor. <i>Refer to LED Operator LED Status Indicators on page 14</i> for detail.
10		LO/RE Light	Illuminated while the drive is under LED Operator control when (LOCAL) is selected to run the drive.
11		ALM LED Light	<i>Refer to LED Screen Display on page 15</i>
12		REV LED Light	
13		DRV LED Light	
14		FOUT LED Light	

<1> o2-01(LOCAL/REMOTE Key Function Selection) is not compatible with J1000. LO/RE Selection Key is always effective.

4 LED Operator Option Components

◆ LED Operator LED Status Indicators

Table 6 LED Status and Meaning

LED	Illuminated	Flashing <f>	Flashing Quickly <f>	Off
LO/RE LED 	When the run command is selected from the LED operator (LOCAL).	—	—	Run command is selected from a device other than the LED operator (REMOTE).
RUN LED 	During run.	<ul style="list-style-type: none"> • During deceleration to stop. • When a run command is input and the frequency reference is 0 Hz. 	<ul style="list-style-type: none"> • During deceleration at a fast-stop. • During stop by External Fault digital input. 	During stop.

<f> For the difference between “Flashing” and “Flashing Quickly” of the RUN LED Status, refer to [Figure 3](#), RUN LED Status.

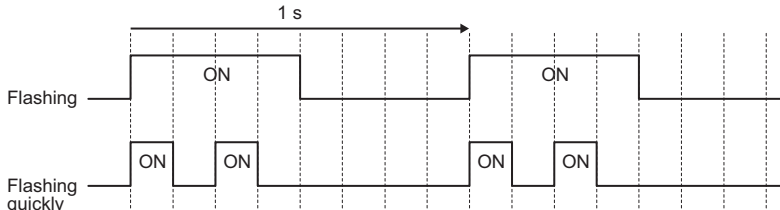

Figure 3 RUN LED Status

4 LED Operator Option Components

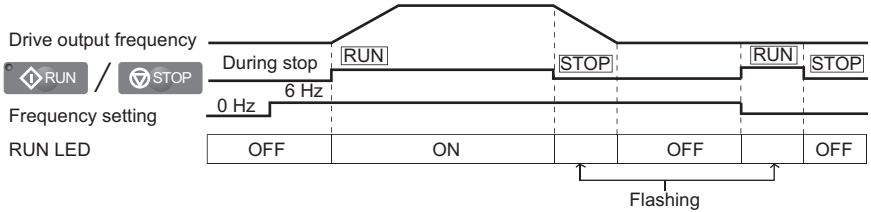

Figure 4 RUN LED and Drive Operation

◆ LED Screen Display

Display	Lit	Flashing	Off
ALM	When the drive detects an alarm or error	<ul style="list-style-type: none"> When an alarm occurs OPE detected 	Normal state (no fault or alarm)
REV	Motor is rotating in reverse	–	Motor is rotating forward
DRV	Drive Mode	–	Programming Mode
FOUT	Displays output frequency (Hz)	–	–
As illustrated in this manual			

5 Installation Procedure

◆ Section Safety

NOTICE

Damage to Equipment

Use only Yaskawa connection cables or recommended cables.

Failure to comply may cause the drive or LED Operator Option to function incorrectly.

Properly connect the connectors.

Failure to comply may prevent proper operation and possibly damage equipment.

Do not exceed communication cable bend radius specifications.

Failure to comply may result in broken wires or loose connections.

◆ LED Operator Option Dimensions

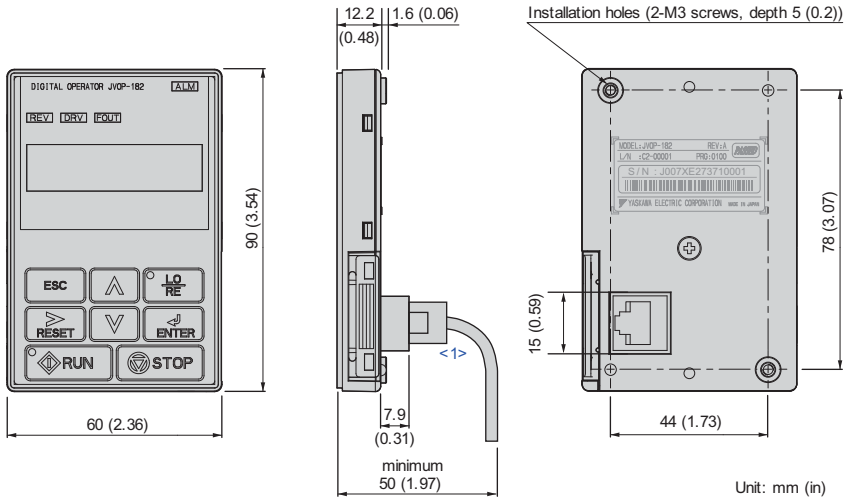

<1> Use only Yaskawa cables or cables recommended by Yaskawa. Refer to [Item Names and Part Numbers \(Sold Separately\) on page 10](#)

Figure 5 Dimensions

◆ Installing the LED Operator Option

There are two different installation methods for the LED Operator Option depending on the application.

1. External/Face-mount: Mounted outside a panel.
2. Internal/Flush-mount: Mounted inside a panel.

Table 7 LED Operator Option Installation Methods

Installation Method	Description	Notes
External/Face-mount	Simplified installation with the LED Operator is mounted on the outside of the panel with two screws.	—

5 Installation Procedure

Installation Method	Description	Notes
Internal/Flush-mount	Encloses the LED Operator Option in the panel. The LED Operator is flush with the outside of the panel.	Requires purchase of separate items. <i>Refer to Item Names and Part Numbers (Sold Separately) on page 10</i>

NOTICE: Prevent foreign matter such as metal shavings or wire clippings from falling into the drive during installation and project construction. Failure to comply could result in damage to the drive. Place a temporary cover over the top of the drive during installation. Remove the temporary cover before startup, as the cover will reduce ventilation and cause the drive to overheat.

External/Face-mount Installation

1. Cut an opening in the enclosure panel for the LED Operator Option according to [Figure 6](#).
2. Position the LED Operator Option so the LED display faces outwards, and mount it to the enclosure panel as shown in [Figure 6](#).

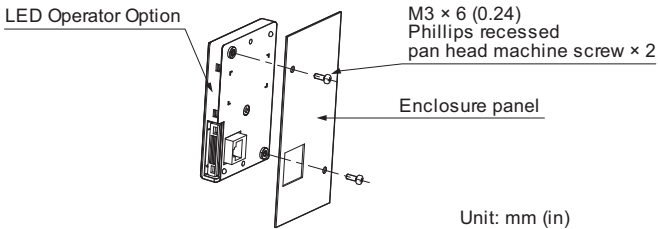

Figure 6 External/Face-mount Installation

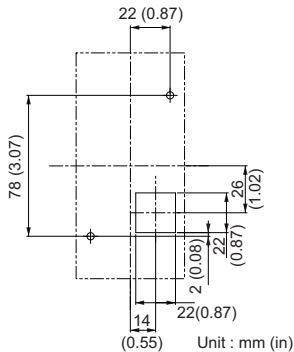

Figure 7 Panel Cut-out Dimensions (External/Face-mount Installation)

Internal/Flush-mount Installation

The internal flush-mount installation method requires an installation support that is purchased separately. *Refer to Item Names and Part Numbers (Sold Separately) on page 10* for information regarding the installation support and mounting hardware. *Figure 8* illustrates how to attach the Installation Support A.

1. Cut an opening in the enclosure panel for the LED Operator Option according to *Figure 9*.
2. Mount the LED Operator Option to the installation support (sold separately).
3. Mount the installation support and LED Operator Option to the enclosure panel.

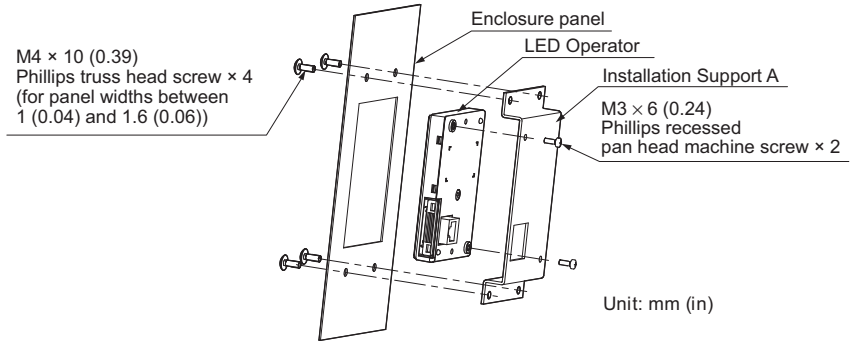

Figure 8 Internal/Flush Mount Installation

Note: For environments with a significant amount of dust or other airborne debris, use a gasket between the enclosure panel and the LED Operator Option.

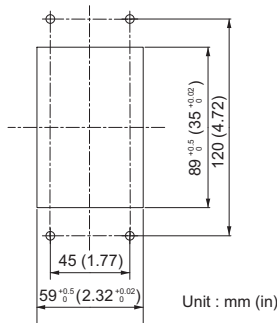

Figure 9 Panel Cut-out Dimensions (Internal/Flush-mount Installation)

5 Installation Procedure

◆ Connecting the LED Operator Option to the Drive

This section contains instructions for connecting the LED operator to V1000 and J1000. For instructions on connecting the LED operator to the other drives, see the Technical Manual of the drive connected to the LED operator.

■ Connecting the LED Operator Option to V1000

Plug the communication cable into the communication cable connector of the LED Operator Option and the drive communications port as shown in **Figure 11**. Ensure both cable ends are firmly connected. **Refer to Item Names and Part Numbers (Sold Separately) on page 10** for information regarding recommended cables.

- Note:** Use only Yaskawa recommended cables. Using a cable not specified may cause the LED Operator or drive to malfunction.
- Note:** The STOP key on the drives built-in LED operator is the only functional key on the built-in LED operator when the LED Operator Option is connected to the drive and parameter b1-02 is set to 0 (LED Operator Option). To disable the STOP key, set parameter o2-02 (STOP key Function Selection) to 0 (Disable).

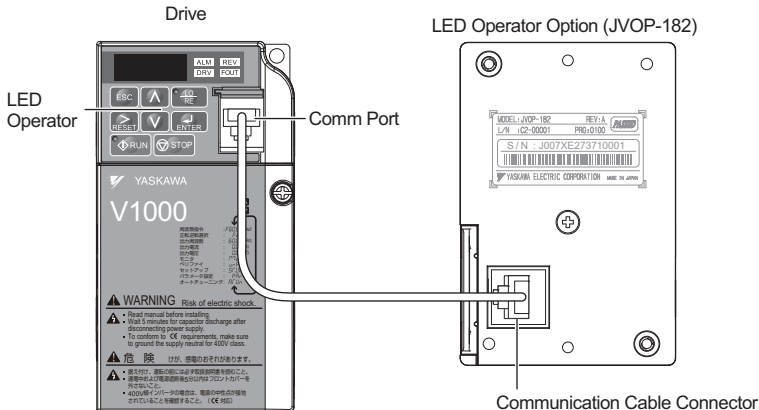

Figure 10 Communication Cable Connection

■ Connecting the LED Operator to J1000

Note: Attach the RS-232C Interface Option (SI-232/J) to the drive before connecting the LED Operator Option to the drive.

Plug the communication cable into the communication cable connector of the LED Operator Option and the communications port of the RS-232C Interface Option (SI-232/J) as shown in **Figure 11**. Ensure both cable ends are firmly connected. **Refer to Item Names and Part Numbers (Sold Separately) on page 10** for information regarding recommended cables.

NOTICE: Use only Yaskawa recommended cables. Using a cable not specified may cause the LED Operator or drive to malfunction.

Note: The STOP key on the drives built-in LED operator is the only functional key on the built-in LED operator when the LED Operator Option is connected to the drive and parameter b1-02 is set to 0 (LED Operator Option). To disable the STOP key, set parameter o2-02 (STOP key Function Selection) to 0 (Disable).

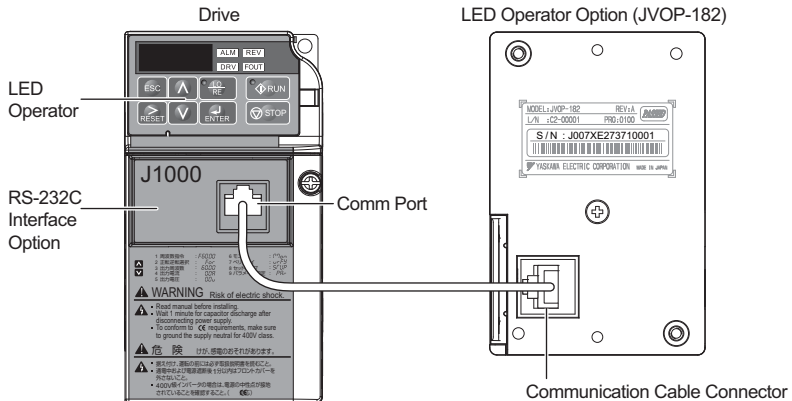

Figure 11 Communication Cable Connection

6 Basic Operation

◆ Basic Operation for LED Operator

The LED Operator Option operates in the same way as the LED Operator built in the drive. Refer to the J1000 Manuals for LED Operator Option main structure and basic Operation.

◆ Functions characteristic of the LED Operator Option

■ Read/Copy Function Procedure

Read

Reads and saves parameter settings from the drive to the LED Operator Option.

The LED Operator Option can perform the Read function an estimated 100,000 times.

Copy











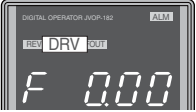





Copies the parameter settings from the LED Operator Option to another Yaskawa drive.

Verify

Verifies parameter settings in the drive match parameter settings saved to the LED Operator Option.

The following procedure is used to read parameters from the drive.

Note: Set parameter o3-02 (Read Allowable) to "1" (Enable) to read the parameter settings from the drive. Set parameter o3-02 to "0" (disable) to protect the parameter settings in the LED Operator Option.

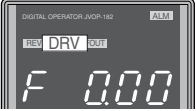
Step	Display/Result
1. Turn on the power to the drive. The initial display appears.	
2. Press  ·  to select the Parameter Setting and Press  .	
3. Press  ·  ·  to select o3-01 (Copy Function Selection) and press  .	
4. Press  ·  to select 01.	
5. Press  and the LED Operator Option will read parameter settings from the drive.	
6. Automatically return to the Copy Function Selection display.	
7. Press  repeatedly until the display returns to the initial display.	

7 Related Parameters

Parameters related to the use of the LED Operator Option are listed below. Set these parameters as needed for the application.

The symbol “○” in the J1000 column indicates this parameter No. applies to the J1000 drive. The symbol “○” in the A1000, V1000 column indicates this parameter No. applies to A1000 and V1000 drives.

Table 8 Related Parameters

No.	Name	Drive		Description	Default
		J1000	A1000·V1000		
b1-01	Frequency Reference Selection 1	○	○	Selects the source of the frequency reference. 0: Operator -Digital preset speed d1-01 to d1-17 1: Terminals - Analog input terminal A1 or A2 2: MEMOBUS/Modbus serial communications 3: Option PCB 4: Pulse Input (Terminal RP) </>	1
b1-02	Run Command Selection 1	○	○	Selects the run command input source. 0: Operator -RUN and STOP keys on the LED Operator Option 1: Digital input terminals S1 to S7 2: MEMOBUS/Modbus serial communications 3: Option PCB </>	1
b1-15	Frequency Reference 2	×	○	Selects the frequency reference input source. 0: Operator - Digital preset speed d1-01 to d1-17 1: Terminals - Analog input terminal A1 or A2 2: MEMOBUS/Modbus serial communications 3: Option PCB 4: Pulse Input (Terminal RP)	0
b1-16	Run Command Source 2	×	○	Selects the Run command input source. 0: Operator - RUN and STOP keys on the LED Operator Option 1: Digital input terminals S1 to S7 2: MEMOBUS/Modbus serial communications 3: Option PCB	0
o2-01	LOCAL/REMOTE Key Function Selection	×	○	Enables/Disables the LED Operator Option LOCAL/REMOTE key. 0: Disabled 1: Enabled	1
o2-02	STOP Key Function Selection	○	○	Enables/Disables the operator panel STOP key when the drive is operated form external sources (not operator). 0: Disabled 1: Enabled	1

7 Related Parameters

No.	Name	Drive		Description	Default
		J1000	A1000-V1000		
o2-05	Frequency Reference Setting Method Selection	<input type="radio"/>	<input type="radio"/>	Selects if the ENTER key press is required when inputting the frequency reference by the operator keypad. 0: Data/Enter key must be pressed to enter a frequency reference. 1: Data/Enter key is not required. The frequency reference is adjusted by the up and down arrow keys.	0
o2-06	Operation Selection when LED Operator Option is Disconnected	<input type="radio"/>	<input type="radio"/>	Sets drive action when the LED Operator Option is removed in LOCAL mode or with b1-02 = 0. 0: The drive will continue operation. 1: The drive will trigger a fault (oPr) and the motor will coast to stop.	0
o3-01	Copy Function Selection	<input type="radio"/>	<input type="radio"/>	This parameter controls the copying of parameters to and from the LED Operator Option. 0: COPY SELECT (no function) 1: All parameters are copied from the drive to the LED Operator Option. 2: All parameters are copied from the LED Operator Option to the drive. 3: Parameter settings in the drive are compared to those in the LED Operator Option. Note: When using the copy function, the drive model number (o2-04), software number (U1-14), and control method (A1-02) must match or an error will occur.	0
o3-02	Copy Allowable	<input type="radio"/>	<input type="radio"/>	Enables or disables reading of drive parameter settings. 0: Disabled - Read not allowed 1: Enabled - Read allowed	0

<1> b1-01 = 4 and b1-02 = 3 are not compatible with the J1000 drive.

8 LED Operator Option Fault Diagnostics

◆ Error Code and Connection Messages

Fault/Error code text will appear on the LED Operator (JVOP-182) display to indicate a specific fault. The fault codes in [Table 9](#) are displayed on the LED operator built in the drive and/or the LED Operator (JVOP-182) displays. For information on the fault codes not listed in [Table 9](#), refer to the drive technical manual.

When an LED Operator (JVOP-182) fault occurs, ensure that the communication cable is properly connected to the LED Operator (JVOP-182) and it is not loose.

Contact your nearest Yaskawa representative or sales department if the cable appears to be connect properly but still no message appears to indicate the error.

Table 9 Fault/Error Code Displays

LED Operator (JVOP-182)	LED Operator (Drive built-in)	Description
CPFD0	</>	LED Operator (JVOP-182) Communication Error 1
		Occurs when the drive cannot communicate with the LED Operator (JVOP-182) within 5 seconds after the power is switched on.
Cause		Possible Solution
Communication cable between the LED Operator (JVOP-182) and the drive is not properly connected.		Remove the LED Operator (JVOP-182) and then reconnect it again.
Problem with the LED Operator (JVOP-182).		Replace the LED Operator (JVOP-182).
Problem with the control circuit in the drive.		<ul style="list-style-type: none"> • Cycle power to the drive. • Replace the drive.
LED Operator (JVOP-182)	LED Operator (Drive built-in)	Description
CPFD1	</>	LED Operator (JVOP-182) Communication Error 2
		Occurs if the drive does not respond to the LED Operator (JVOP-182) for over 2 seconds.
Cause		Possible Solution
Connector on the LED Operator (JVOP-182) cable is loose or damaged.		Remove the LED Operator (JVOP-182) and then reconnect it again.
Problem with the LED Operator (JVOP-182).		Replace the LED Operator (JVOP-182).
Problem with the control circuit in the drive.		<ul style="list-style-type: none"> • Cycle power to the drive. • Replace the drive.

8 LED Operator Option Fault Diagnostics

LED Operator (JVOP-182)	LED Operator (Drive built-in)	Description
oPr	oPr	<p>LED Operator Option Connection Fault</p> <p>Data should appear on the LED operator built in the drive. By reconnecting the LED operator (JVOP-182) to the drive, data should also appear on the LED Operator (JVOP-182) display.</p> <p>An oPr fault will occur if all of the following conditions are true:</p> <p>Output is interrupted when the LED Operator (JVOP-182) is disconnected (o2-06 = 1).</p> <p>The run command is assigned to the LED Operator (JVOP-182) (b1-02/b1-16= 0 and LOCAL is selected).</p>
Cause		Possible Solution
LED Operator (JVOP-182) is not properly connected to the drive.		<ul style="list-style-type: none"> • Check the connection between the LED Operator (JVOP-182) and the drive. • Replace the cable if damaged. • Turn off the drive input power and disconnect the LED Operator (JVOP-182). Reconnect the LED Operator (JVOP-182) and reapply drive input power.

<1> Display will vary depending on operation status.

9 Specifications

Table 10 LED Operator Option Specifications



Model	JVOP-182
Connector	RJ-45
Power Supply	Powered from the drive (DC +5 V \pm 5%)
Operating Temperature	-10 to +50 °C
Humidity	up to 95% RH (no condensation)
Storage Temperature	-20 to +60 °C (allowed for short-term transport of the product)
Area of Use	Indoor (free of corrosive gas, airborne particles, etc.)
Altitude	Up to 1000 m
Shock	10 to 20 Hz : 9.8 m/s ² 20 to 55 Hz : 5.9 m/s ²
Read Function Limitation	Estimated 100,000 times

10 Revision History

The revision dates and numbers of the revised manuals are given on the bottom of the back cover.

MANUAL NO. TOBP C730600 35A

Published in Japan September 2008 08-3 
└─ Date of publication └─ Date of original publication └─ Revision number

Date of Publication	Rev. No.	Section	Revised Content
March 2008	–	–	First edition
September 2008		Back cover	Revision: Address
December 2008		All chapters	Revision: Application to the A1000 drive and V1000 drive

YASKAWA AC Drive Option

LED Operator

Installation Manual

IRUMA BUSINESS CENTER (SOLUTION CENTER)

480, Kamifuji-sawa, Iruma, Saitama 358-8555, Japan
Phone 81-4-2962-5696 Fax 81-4-2962-6138

YASKAWA ELECTRIC AMERICA, INC.

2121 Norman Drive South, Waukegan, IL 60085, U.S.A.
Phone 1-847-887-7000 Fax 1-847-887-7370

YASKAWA ELÉTRICO DO BRASIL LTDA.

Avenida Fagundes Filho, 620 São Paulo-SP CEP 04304-000, Brazil
Phone 55-11-3585-1100 Fax 55-11-5581-8795

YASKAWA ELECTRIC EUROPE GmbH

Hauptstraße 185, 65760 Eschborn, Germany
Phone 49-6196-569-300 Fax 49-6196-569-398

YASKAWA ELECTRIC UK LTD.

1 Hunt Hill Orchardton Woods Cumbernauld, G68 9LF, United Kingdom
Phone 44-1236-735000 Fax 44-1236-458182

YASKAWA ELECTRIC KOREA CORPORATION

7F, Doore Bldg. 24, Yeoido-dong, Youngdungpo-Ku, Seoul 150-877, Korea
Phone 82-2-784-7844 Fax 82-2-784-8495

YASKAWA ELECTRIC (SINGAPORE) PTE. LTD.

151 Lorong Chuan, #04-01, New Tech Park 556741, Singapore
Phone 65-6282-3003 Fax 65-6289-3003

YASKAWA ELECTRIC (SHANGHAI) CO., LTD.

No.18 Xizang Zhong Road, Room 1702-1707, Harbour Ring Plaza Shanghai 200001, China
Phone 86-21-5385-2200 Fax 86-21-5385-3299

YASKAWA ELECTRIC (SHANGHAI) CO., LTD. BEIJING OFFICE

Room 1011A, Tower W3 Oriental Plaza, No.1 East Chang An Ave.,
Dong Cheng District, Beijing 100738, China
Phone 86-10-8518-4086 Fax 86-10-8518-4082

YASKAWA ELECTRIC TAIWAN CORPORATION

9F, 16, Nanking E. Rd., Sec. 3, Taipei, Taiwan
Phone 886-2-2502-5003 Fax 886-2-2505-1280



YASKAWA

YASKAWA ELECTRIC CORPORATION

In the event that the end user of this product is to be the military and said product is to be employed in any weapons systems or the manufacture thereof, the export will fall under the relevant regulations as stipulated in the Foreign Exchange and Foreign Trade Regulations. Therefore, be sure to follow all procedures and submit all relevant documentation according to any and all rules, regulations and laws that may apply. Specifications are subject to change without notice for ongoing product modifications and improvements.

© 2008 YASKAWA ELECTRIC CORPORATION. All rights reserved.

MANUAL NO. TOBP C730600 35B

Published in Japan December 2008 08-3 -0
08-5-3