

LC1 F115
LC1 F150
LC1 F185
LC1 F225
LC1 F265
LC1 F330

LC1 F400
LC1 F500

LC1 F630
LC1 F800

LC1 F1250

"For Motor Starting Use Schneider Electric Overload Relay Series LR"
 "Pour le démarrage du moteur, utilisez un relais de surcharge de série LR Schneider Electric"
 "Für den Motorstart die Überlastrelais der LR-Serie von Schneider Electric verwenden"
 "Per l'avvio del motore, utilizzare il relé di sovraccarico Schneider Electric delle serie LR"
 "Para el arranque del motor, utilice relés de sobrecarga de la serie LR de Schneider Electric"
 "Para inicialização do motor, use o relé de sobrecarga série LR da Schneider Electric"
 "Для запуска двигателя используйте реле перегрузки Schneider Electric серии LR"
 "如要启动电机, 请使用 Schneider Electric 的 LR 系列过载继电器"



DANGER / DANGER / GEFAHR / PERICOLO / PELIGRO / PERIGO / ОПАСНОСТЬ / 危險

HAZARD OF ELECTRIC SHOCK, EXPLOSION, OR ARC FLASH

Disconnect all power before servicing equipment.
Failure to follow these instructions will result in death or serious injury.

RISQUE D'ÉLECTROCUTION, D'EXPLOSION OU D'ECLAIR D'ARC ELECTRIQUE

Coupez toutes les alimentations avant de travailler sur cet appareil.

Si ces directives ne sont pas respectées, cela entraînera la mort ou des blessures graves.

GEFAHR VON ELEKTRISCHEM SCHLAG, EXPLOSION ODER LICHTBOGEN

Vor dem Arbeiten am Gerät alle Spannungsversorgungen abschalten.
Die Nichtbeachtung dieser Anweisungen führt zu Tod oder schweren Verletzungen.

RISCHIO DI SCARICA ELETTRICA, ESPLOSIONE O ARCO ELETTRICO

Scollegare l'appare cchio da tutti i circuiti di alimentazione prima di qualsiasi intervento.
Il mancato rispetto di queste istruzioni provocherà morte o gravi infortuni.

PELIGRO DE DESCARGA ELÉCTRICA, EXPLOSIÓN O ARCO ELECTRICO

Desconecte todas las alimentaciones antes de manipular el producto.
El incumplimiento de estas instrucciones podrá causar la muerte o lesiones serias.

RISCO DE ELECTROCUSSÃO, DE EXPLOSAÕ, OU DE ARCO ELÉCTRICO

Desconecte todas as alimentações antes de manipular o produto.
A não observância destas instruções resultará em morte, ou ferimentos graves.

Опасность поражения электрическим током, опасность взрыва или вспышки дуги.

Перед обслуживанием или ремонтом убедитесь, что питание отключено.
Несоблюдение этих инструкций приведет к смерти или серьезной травме.

电击、爆炸或弧闪的危险

在此电力设备上工作时, 请先切断所有电源。
 不遵循上述说明将导致人员伤亡。



LC1 F115...F330

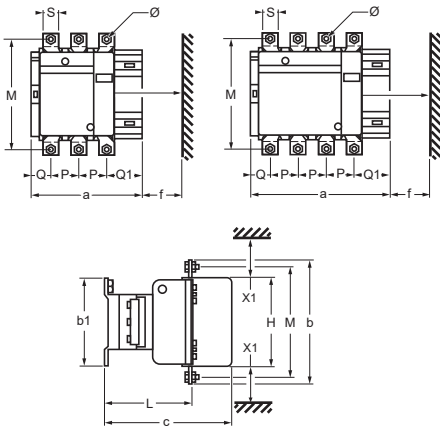

LC1 F400...F500

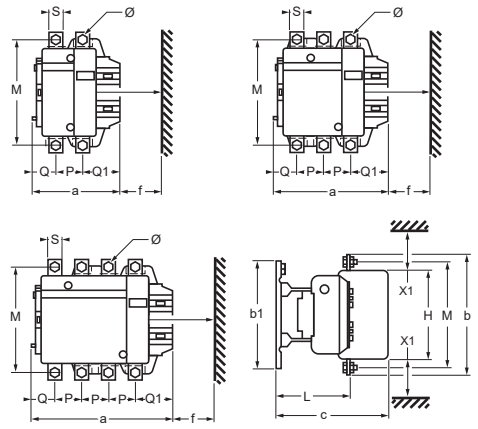

LC1 F630...F800

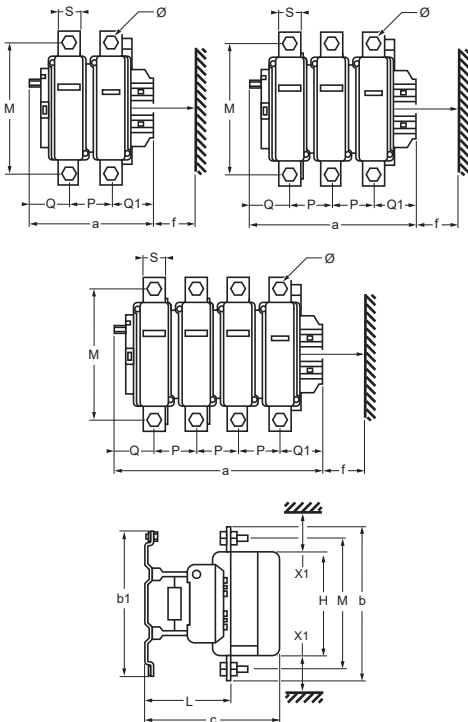

LC1 F1250

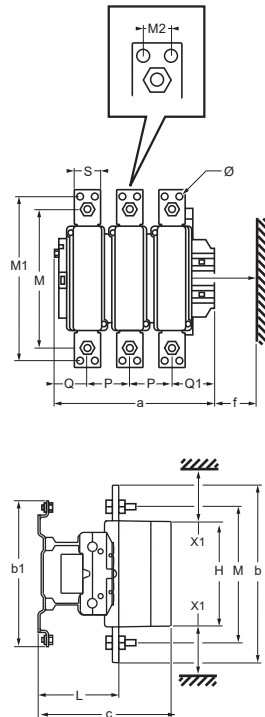



mm	LC1 F115		LC1 F150		LC1 F185		LC1 F225		LC1 F265	
	115	1154	150	1504	185	1854	225	2254	265	2654
a	163,5	200,5	163,5	200,5	168,5	208,5	168,5	208,5	201,5	244,5
P	37	37	40	40	40	40	48	48	48	48
Q	29,5	29,5	26	26	29	29	21	17	39	34
Q1	60	60	57,5	55,5	59,5	59,5	51,5	47,5	66,5	66,5
S	20	20	20	20	20	20	25	25	25	25
Ø	M6	M6	M8	M8	M8	M8	M10	M10	M10	M10
f	131	131	131	131	130	130	130	130	147	147
b	162	162	170	170	174	174	197	197	203	203
b1	137	137	137	137	137	137	137	137	145	145
M	147	147	150	150	154	154	172	172	178	178
H	124	124	124	124	127	127	127	127	147	147
c	171	171	171	171	181	181	181	181	213	213
L	107	107	107	107	113,5	113,5	113,5	113,5	141	141
X1 220...500 V 660...1000 V	10 15		10 15		10 15		10 15		10 15	

inches = mm x 0.0394

mm	LC1 F330		LC1 F400			LC1 F500			LC1 F630...F800			LC1 F1250
	330	3304	4002	400	4004	5002	500	5004	6302	630 800	6304	1250
a	213	261	213	213	261	233	233	288	309	309	389	309
P	48	48	48	48	48	55	55	55	80	80	80	80
Q	43	43	69	43	43	76	46	46	102	60	60	60
Q1	74	74	96	74	74	102	77	77	127	89	89	89
S	25	25	25	25	25	30	30	30	40	40	40	50
Ø	M10	M10	M10	M10	M10	M10	M10	M10	M12	M12	M12	M12
f	147	147	146	146	146	150	150	150	181	181	181	181
b	206	206	206	206	206	238	238	238	304	304	304	338
b1	145	145	209	209	209	209	209	209	280	280	280	280
M	181	181	181	181	181	208	208	208	264	264	264	264
M1	-	-	-	-	-	-	-	-	-	-	-	312
M2	-	-	-	-	-	-	-	-	-	-	-	28
H	158	158	158	158	158	172	172	172	202	202	202	202
c	219	219	219	219	219	232	232	232	255	255	255	255
L	145	145	145	145	145	146	146	146	155	155	155	155
X1 220...500 V 660...1000 V	10 15		15 20			15 20			20 30			20 30

B

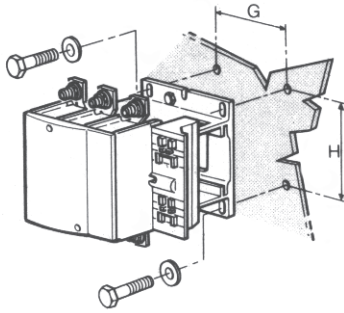

LC1 F	115/1154 150/1504 185/1854 225/2254	265/2654 330/3304	400/4002 4004 500/5002	5004	630/6302 800	6304	1250
G (mm)	80	96	80	140	180	240	180
H (mm)	110 - 120		170 - 180		180 - 190		

inches = mm x 0.0394

C

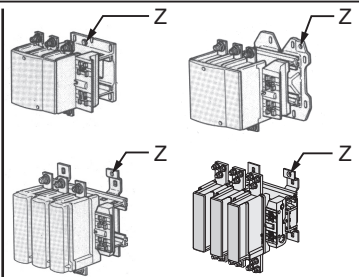
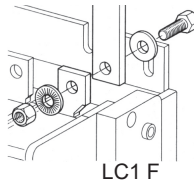
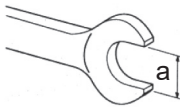

LC1 F	a (mm)	C (N.m)
115/1154	10	10
150/1504/185/1854	13	18
225 ... 5004	16	35
630/6304/800/1250	18	58

lb-in = N.m x 8.85

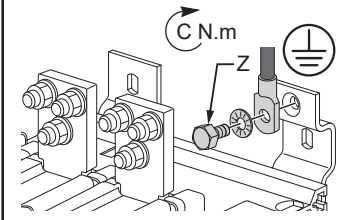
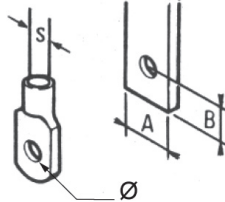
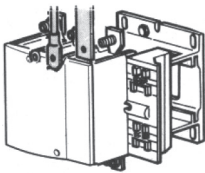

	115	150	185	225	265	330	400	500	630	800	1250
A (mm)	≤ 20	≤ 25	≤ 25	≤ 30	≤ 30	≤ 30	≤ 30	≤ 40	≤ 60	≤ 60	≤ 60
B (mm)	10	12,5	12,5	15	15	15	15	20	25	25	25
Ø (mm)	6,6	9	9	11	11	11	11	11	13	13	13
S (mm ²)	95	120	150	185	240	240	2x150	2x240	-	-	-
C (N.m)	10	18	18	35	35	35	35	35	58	58	58
Z ⚡	M8x10	M8x10	M8x10	M8x10	M10x12	M10x12	M10x12	M10x12	M12x20	M12x20	M12x20
C (N.m) ⚡	10	10	10	10	10	10	35	35	58	58	58

inches = mm x 0.0394

lb-in = N.m x 8.85

D

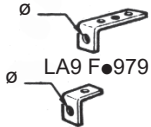
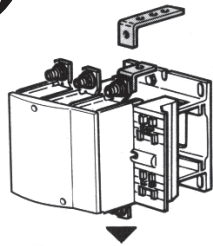

LA9 F●981

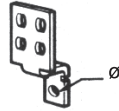
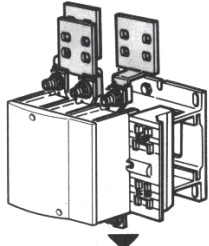

LA9 F●980

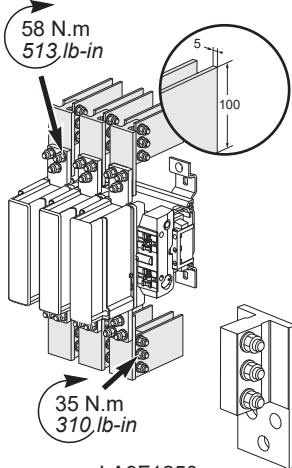

LA9F1250

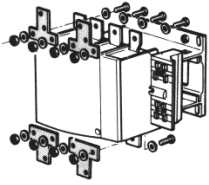

LA9 F●602

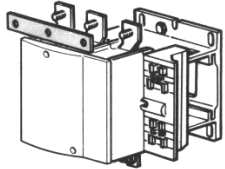

LA9 F●601

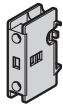

LC1 F ▼	3 x	3 x	3 x	4 x	1 x	6 x
	115 150 185 225 265 330 400 500 630 800 1250	LA9 FF981 LA9 FG981 LA9 FJ981 LA9 FJ981 LA9 FJ981 LA9 FJ981 LA9 FJ981 LA9 FJ981 LA9 FK981 LA9 FL981 LA9 FL981	LA9 FF979 LA9 FG979 LA9 FJ979 LA9 FJ979 LA9 FJ979 LA9 FJ979 LA9 FJ979 LA9 FJ979 LA9 FK979 LA9 FL979 LA9 FL979	LA9 FF980 LA9 FG980 LA9 FJ980 LA9 FJ980 LA9 FJ980 LA9 FJ980 LA9 FJ980 LA9 FJ980 LA9 FK980 LA9 FL980 -	LA9 FF602 LA9 FG602 LA9 FH602 LA9 FH602 LA9 FH602 LA9 FH602 LA9 FH602 LA9 FH602 LA9 FK602 LA9 FL602 -	LA9 FF601 LA9 FG601 LA9 FH601 LA9 FH601 LA9 FH601 LA9 FH601 LA9 FH601 LA9 FH601 LA9 FK601 LA9 FL601 -

E

LA DN 10
01

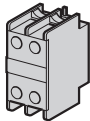

LA DN 11
20
02

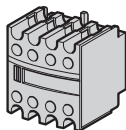

LA DN
LA DC
LA1 DX (1)
DZ (1)
DY (1)

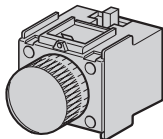

LA DS
LA DT
LA DR

1 "F"	LA DN10
(NO)	
1 "O"	LA DN01
(NC)	
1 "F" + 1 "O"	LA DN11
(NO) (NC)	
2 "F"	LA DN20
(NO)	
2 "O"	LA DN02
(NC)	
2 "F" + 2 "O"	LA DN22
(NO) (NC)	
1 "F" + 3 "O"	LA DN13
(NO) (NC)	
4 "F"	LA DN40
(NO)	
4 "O"	LA DN04
(NC)	
3 "F" + 1 "O"	LA DN31
(NO) (NC)	
2 "F" + 2 "O"	LA DC22
(NO) (NC)	
2 "F"	LA1 DX20 (1)
(NO)	
2 "F" + 2 "F"	LA1 DZ40 (1)
(NO) (NO)	
1 "F" + 1 "O" + 2 "F"	LA1 DZ31 (1)
(NO) (NC) (NO)	
2 "F"	LA1 DY20 (1)
(NO)	

(1) LA1 DX/DY/DZ

Dust-tight

Environnement polluant

Für verschmutzte Umgebung

Ambienti polverosi

Ambiente polvoriento

Пылезащищенный

防尘

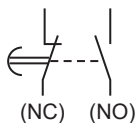

0,1 ... 3 s
0,1 ... 30 s
1 ... 30 s
10 ... 180 s

LA DT0
LA DT2
LA DS2
LA DT4

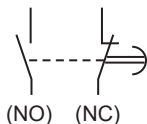

0,1 ... 3 s
0,1 ... 30 s
10 ... 180 s

LA DR0
LA DR2
LA DR4

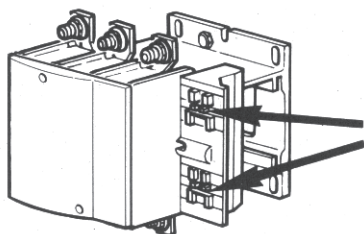
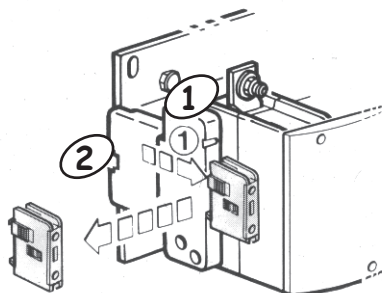
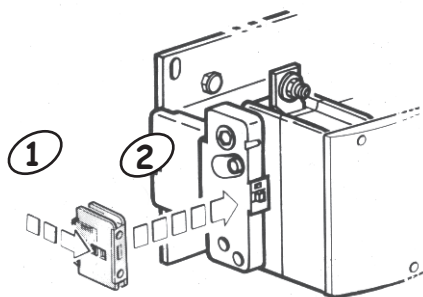
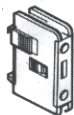
FLA DN
10
01

+

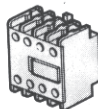
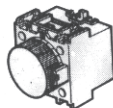
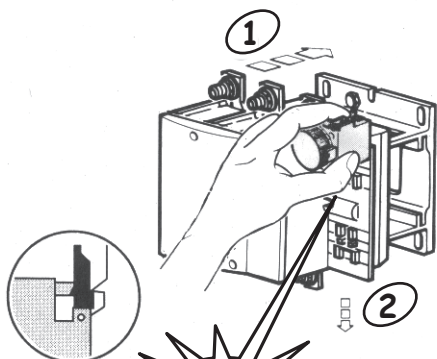

LA DN.

LA DN.
LA DC.
LA1 D.LA DS.
LA DT.
LA DR.

Click!

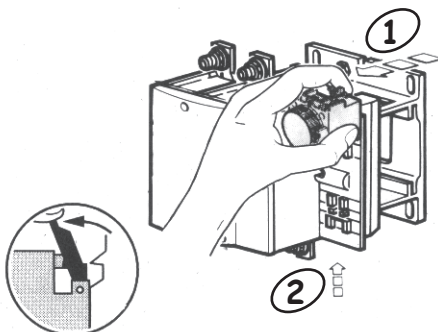



LX9 F... ~
LX4 F8... ~ / ~
LX4 F... ~

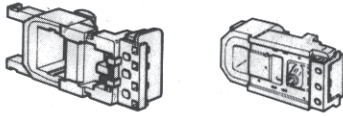

(LC1 F115 ... F225) (LC1 F265 ... F1250)

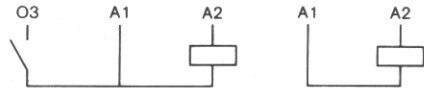

LC1 F115 ... F330

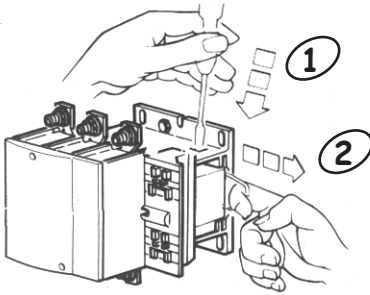

LC1 F400 ... F1250

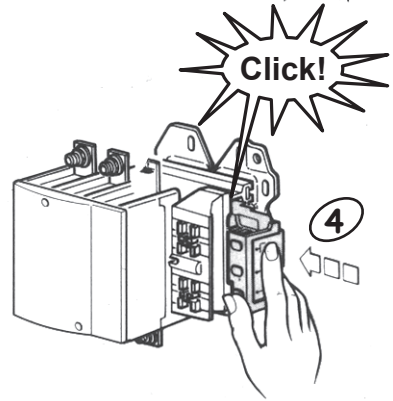
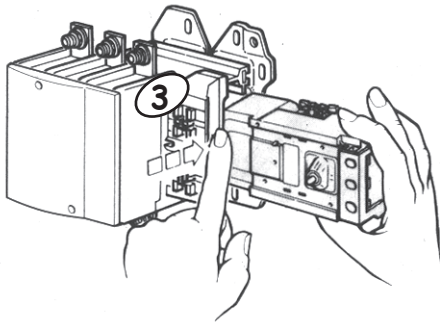
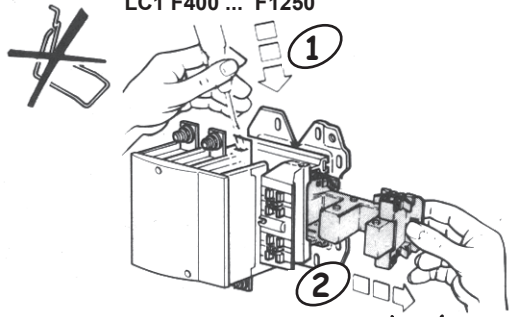

LC1 F6304

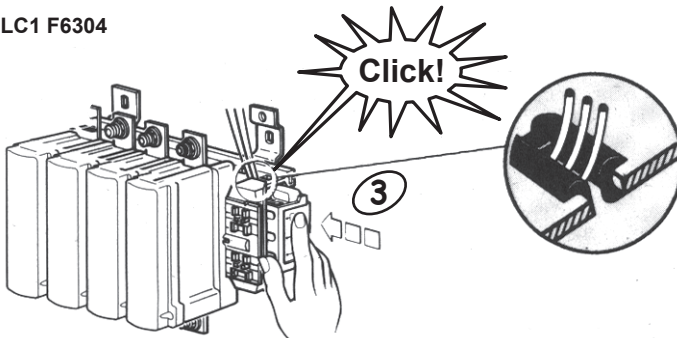

H

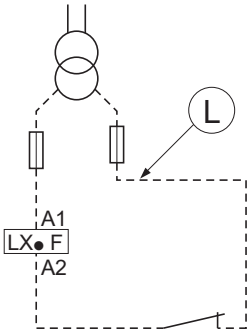
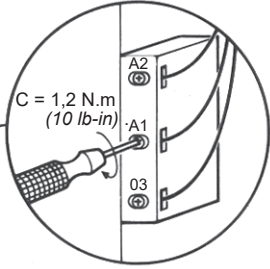
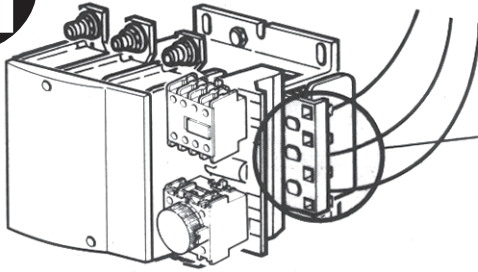

$C = 1,2 \text{ N.m}$
 $C = 10 \text{ lb-in}$

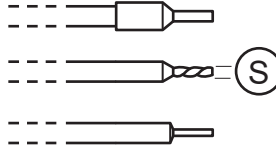

LX1 F ~
LX4 F8 ~ / ∩

LX1 F / LX9 F ~

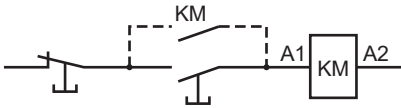

LX4-F
∩

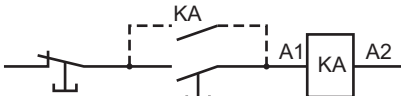

48 V {
110 V {
125 V {

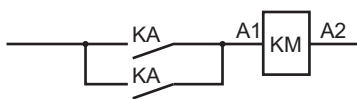

220 V {
250 V {
440 V {

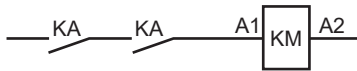

LC1 F115 ... 330		
LX• F ~ / ∩	L ≤ ••• m	S ≥ •• mm ²
24 V	4 7	2,5 4
48 V	10 20 30	1,5 2,5 4
110 V	40 60 100 150	1 1,5 2,5 4
220 V	150 250 400 600	1 1,5 2,5 4
380 V 440 V	500 750 1200	1 1,5 2,5

LC1 F400 ... 1250		
LX• F ~ / ∩	L ≤ ••• m	S ≥ •• mm ²
48 V	4 6 10	1,5 2,5 4
110 V	15 20 40 60	1 1,5 2,5 4
220 V	60 90 150 250	1 1,5 2,5 4
380 V 440 V	180 270 500	1 1,5 2,5

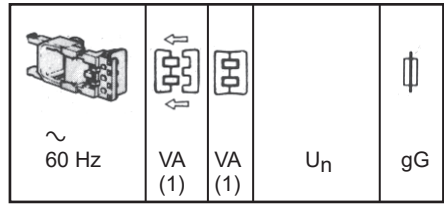
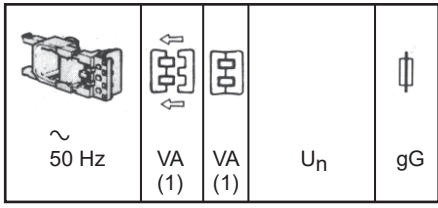

LC1 F115/F150				
LX1 FF024	550	45	24 V	12 A
LX1 FF042	"	"	42 V	8 A
LX1 FF048	"	"	48 V	6 A
LX1 FF110	"	"	110/115 V	4 A
LX1 FF127	"	"	127 V	4 A
LX1 FF220	"	"	220/230 V	2 A
LX1 FF240	"	"	240 V	2 A
LX1 FF380	"	"	380/400 V	1 A
LX1 FF415	"	"	415/440 V	1 A
LX1 FF500	"	"	500 V	1 A
LX1 FF660	"	"	660 V	1 A

LC1 F115/F150				
LX1 FF040	660	55	48 V	6 A
LX1 FF092	"	"	110 V	4 A
LX1 FF095	"	"	115/120 V	4 A
LX1 FF162	"	"	200/208 V	2 A
LX1 FF184	"	"	220 V	2 A
LX1 FF187	"	"	230/240 V	2 A
LX1 FF340	"	"	415 V	2 A
LX1 FF360	"	"	440 V	1 A
LX1 FF380	"	"	460/480 V	1 A
LX1 FF550	"	"	660 V	1 A

LC1 F185/F225				
LX1 FG024	805	55	24 V	16 A
LX1 FG042	"	"	42 V	8 A
LX1 FG048	"	"	48 V	8 A
LX1 FG110	"	"	110/115 V	4 A
LX1 FG127	"	"	127 V	4 A
LX1 FG220	"	"	220/230 V	2 A
LX1 FG240	"	"	240 V	2 A
LX1 FG380	"	"	380/400 V	1 A
LX1 FG415	"	"	415/440 V	1 A
LX1 FG500	"	"	500 V	1 A
LX1 FG660	"	"	660 V	1 A

LC1 F185/F225				
LX1 FG040	970	66	48 V	10 A
LX1 FG092	"	"	110 V	6 A
LX1 FG095	"	"	115/120 V	6 A
LX1 FG162	"	"	200/208 V	4 A
LX1 FG184	"	"	220 V	4 A
LX1 FG187	"	"	230/240 V	4 A
LX1 FG340	"	"	415 V	2 A
LX1 FG360	"	"	440 V	2 A
LX1 FG380	"	"	460/480 V	2 A
LX1 FG550	"	"	660 V	1 A

(1) $\theta = 20\text{ }^\circ\text{C}$



~ 40...400 Hz	VA (1)	VA (1)	U_n	gG

~ 40...400 Hz	VA (1)	VA (1)	U_n	gG

LC1 F265/F330				
LX1 FH0482			48 V	10 A
LX1 FH1102	600	8	110/115 V	6 A
LX1 FH1275			120/127 V	6 A
LX1 FH2202	700	10	220/230 V	4 A
LX1 FH2402			240 V	4 A
LX1 FH3802			380/415 V	2 A
LX1 FH5002			480/500 V	2 A

LC1 F500				
LX1 FK048			48 V	10 A
LX1 FK110	1050	16	110/120 V	6 A
LX1 FK127			127 V	6 A
LX1 FK220	1150	20	220/230 V	4 A
LX1 FK240			240 V	4 A
LX1 FK380			380/400 V	2 A
LX1 FK415			415/480 V	2 A
LX1 FK500			500 V	2 A

LC1 F400				
LX1 FJ048			48 V	10 A
LX1 FJ110	1000	12	110/120 V	6 A
LX1 FJ127			127 V	6 A
LX1 FJ220	1150	18	220/230 V	4 A
LX1 FJ240			240 V	4 A
LX1 FJ380			380/400 V	2 A
LX1 FJ415			415/480 V	2 A
LX1 FJ500			500 V	2 A

LC1 F630/F1250				
LX1 FL048 <small>(LC1 F630 only)</small>			48 V	16 A
LX1 FL110	1500	20	110/120 V	8 A
LX1 FL127			127 V	8 A
LX1 FL220	1730	25	220/240 V	6 A
LX1 FL380			380/400 V	4 A
LX1 FL415			415/440 V	2 A
LX1 FL500			500 V	2 A

LC1 F800					
LX4 F8FW	1700	11	110/127 V	16 A	DR5 TE4U
LX4 F8MW	1700	11	220/240 V	6 A	DR5 TE4U
LX4 F8QW	1700	11	380/440 V	2 A	DR5 TE4S

(1) 50/60 Hz, $\theta = 20^\circ\text{C}$

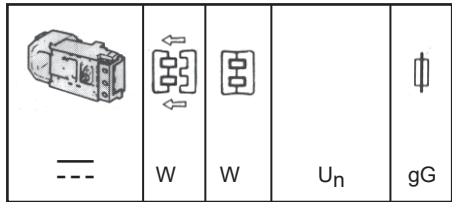
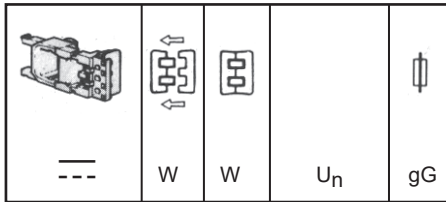

LC1 F115/150				
LX4 FF024	543 ↑ ↓	3,94 ↑ ↓	24 V	12 A
LX4 FF048			48 V	6 A
LX4 FF110			110 V	4 A
LX4 FF125			125 V	4 A
LX4 FF220	665	4,83	220/230 V	2 A
LX4 FF440			440/460 V	1 A

LC1 F400				
LX4 FJ048	920 ↑ ↓	4 ↑ ↓	48 V	10 A
LX4 FJ110			110 V	6 A
LX4 FJ125			125 V	6 A
LX4 FJ220			220 V	4 A
LX4 FJ250	1140	7,5	250 V	4 A
LX4 FJ440			440 V	2 A

LC1 F185/225				
LX4 FG024	737 ↑ ↓	4,13 ↑ ↓	24 V	16 A
LX4 FG048			48 V	8 A
LX4 FG110			110 V	4 A
LX4 FG125			125 V	4 A
LX4 FG220	902	5,07	220/230 V	2 A
LX4-FG440			440/460 V	1 A

LC1 F500				
LX4 FK048	990 ↑ ↓	4,5 ↑ ↓	48 V	10 A
LX4 FK110			110 V	6 A
LX4 FK125			125 V	6 A
LX4 FK220			220 V	4 A
LX4 FK250	1220	8	250 V	4 A
LX4-FK440			440 V	2 A

LC1 F265/330				
LX4 FH024	655 ↑ ↓	3,68 ↑ ↓	24 V	16 A
LX4 FH048			48 V	8 A
LX4 FH110			110 V	4 A
LX4 FH125			125 V	4 A
LX4 FH220	803	4,53	220/230 V	2 A
LX4 FH440			440/460 V	1 A

LC1 F630/F1250				
LX4 FL048	1420 ↑ ↓	6,5 ↑ ↓	48 V	16 A
LX4 FL110			110 V	8 A
LX4 FL125			125 V	8 A
LX4 FL220			220 V	4 A
LX4 FL250	1920	12,5	250 V	4 A
LX4 FL440 (LC1 F630 only)			440 V	2 A

LC1 F800				
LX4 F8FW	1900	10	110/120 V	8 A
LX4 F8MW	1900	10	220/240 V	4 A
LX4 F8QW	1900	10	380/400 V	2 A



			U_n	gG
~ 40...400 Hz	VA (1)	VA (1)		

			U_n	gG
~ 40...400 Hz	VA (1)	VA (1)		

LC1 F115/150				
LX9 FF024	690	6,6	24 V	12 A
LX9 FF042			42 V	10 A
LX9 FF048			48 V	8 A
LX9 FF110			110/115 V	4 A
LX9 FF127			120/127 V	4 A
LX9 FF132			132 V	4 A
LX9 FF200			200/208 V	2 A
LX9 FF220			220/230 V	2 A
LX9 FF240			240 V	2 A
LX9 FF265			265 V	2 A
LX9 FF280			277 V	2 A
LX9 FF380			380/400 V	2 A
LX9 FF415			415/440 V	1 A
LX9 FF480			460/480 V	1 A
LX9 FF500			855	8,1
LX9 FF575			575 V	1 A

LC1 F185/225				
LX9 FG024	950	8,9	24 V	16 A
LX9 FG042			42 V	16 A
LX9 FG048			48 V	10 A
LX9 FG110			110/115 V	6 A
LX9 FG127			120/127 V	6 A
LX9 FG132			132 V	4 A
LX9 FG200			200/208 V	4 A
LX9 FG220			220/230 V	4 A
LX9 FG240			240 V	4 A
LX9 FG265			265 V	4 A
LX9 FG280			277 V	2 A
LX9 FG380			380/400 V	2 A
LX9 FG415			415/440 V	2 A
LX9 FG480			460/480 V	2 A
LX9 FG500			1180	10,9
LX9 FG575			575 V	1 A

(1) 50/60 Hz, $\theta = 20\text{ }^\circ\text{C}$

The following products meet the Energy Efficiency requirements.
 The power consumption and the Energy Efficiency grades are:
 以下型号产品符合能效要求，产品的吸持功率和能效等级分别如下：

Product Type 产品型号	LC1F115 LC1F150	LC1F185 LC1F400	LC1F225 LC1F500	LC1F265 LC1F630	LC1F300 LC1F1250
Maximum power consumption lower than 最大吸持功率低于 (VA)	51.3	91.2			
Energy efficiency grade 能效等级	2		2		

	200V - 208V	220V - 240V	460V - 480V	575V - 600V	SCCR	Type J Fuse Ampacity Maximum
Contactors	HP	HP	HP	HP	KA	A
LC1F115	30	40	75	100	100	200
CR1F150/LC1F150	40	50	100	125	100	200
CR1F185/LC1F185	50	60	125	150	100	400
CR1F265/LC1F265	60	75	150	200	100	600
LC1F330	75	100	200	250	100	600

产品中有毒有害物质或元素的名称及含量
 Contents of Toxic or Hazardous Substances or Elements

部件名称 Part Name	有毒有害物质或元素 Toxic or hazardous Substances and Elements					
	铅 (Pb)	汞 (Hg)	镉 (Cd)	六价铬 (Cr ⁶⁺)	多溴联苯 (PBB)	多溴二苯醚 (PBDE)
金属部件 Metal Parts	X	O	O	O	O	O

O : 表示该有毒有害物质在该部件所有均质材料中的含量均在 SJ/T11363-2006 标准规定的限量要求以下。
 Indicates that this toxic or hazardous substance contained in all of the homogeneous materials for this part is below the limit requirement in SJ/T11363-2006.

X : 表示该有毒有害物质至少在该部件的某一均质材料中的含量超出 SJ/T11363-2006 标准规定的限量要求。
 Indicates that this toxic or hazardous substance contained in at least one of the homogeneous materials used for this part is above the limit requirement in SJ/T11363-2006

对销售之日的所售产品,本表显示,
 施耐德电气供应链的电子信息技术产品可能包含这些物质。注意:在所售产品中可能会也可能不会含有所有所列的部件。
 Note: The products on sale may or may not contain all the parts/components listed here.

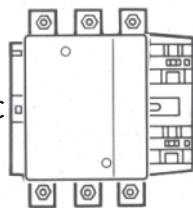
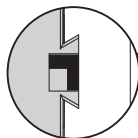
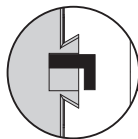
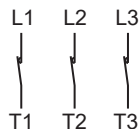
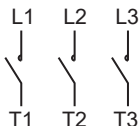
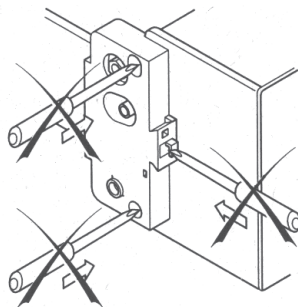
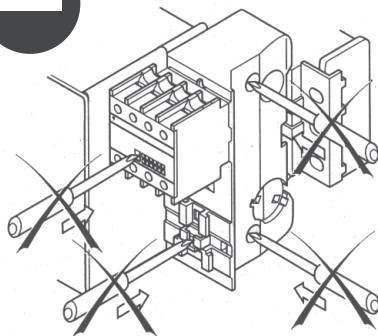
J**K**

DANGER / DANGER / GEFAHR / PERICOLO / PELIGRO / PERIGO / ОПАСНОСТЬ / 危險

HAZARD OF ELECTRIC SHOCK, EXPLOSION, OR ARC FLASH

Disconnect all power before servicing equipment.
Failure to follow these instructions will result in death or serious injury.

RISQUE D'ÉLECTROCUTION, D'EXPLOSION OU D'ÉCLAIR D'ARC ÉLECTRIQUE

Coupez toutes les alimentations avant de travailler sur cet appareil.
Si ces directives ne sont pas respectées, cela entraînera la mort ou des blessures graves.

GEFAHR VON ELEKTRISCHEM SCHLAG, EXPLOSION ODER LICHTBOGEN

Vor dem Arbeiten am Gerät alle Spannungsversorgungen abschalten.
Die Nichtbeachtung dieser Anweisungen führt zu Tod oder schweren Verletzungen.

RISCHIO DI SCARICA ELETTRICA, ESPLOSIONE O ARCO ELETTRICO

Scollegare l'apparecchio da tutti i circuiti di alimentazione prima di qualsiasi intervento.
Il mancato rispetto di queste istruzioni provocherà morte o gravi infortuni.

PELIGRO DE DESCARGA ELÉCTRICA, EXPLOSIÓN O ARCO ELÉCTRICO

Desconecte todas las alimentaciones antes de manipular el producto.
El incumplimiento de estas instrucciones podrá causar la muerte o lesiones serias.

RISCO DE ELECTROCUSSÃO, DE EXPLOSIÃO, OU DE ARCO ELÉCTRICO

Desconecte todas as alimentações antes de manipular o produto.
A não observância destas instruções resultará em morte, ou ferimentos graves.

Опасность поражения электрическим током, опасность взрыва или вспышки дуги.

Перед обслуживанием или ремонтом убедитесь, что питание отключено.
Несоблюдение этих инструкций приведет к смерти или серьезной травме.

电击、爆炸或弧闪的危险

在此电力设备上工作时, 请先切断所有电源不遵循上述说明将导致人员伤亡。



Contact wear indicator
Contrôle d'usure des contacts
Prüfung der Abnutzung der Kontakte
Controllo dello stato di usura dei contatti
Control del desgaste de los contactos
Индикатор износа контакта
触点磨损指示器

■ The blackening of the contacts and the arc-boxes is a natural consequence which occurs during normal operation, and does not effect the functioning of the product.

■ Le noircissement des contacts et des boîtiers d'arc est un phénomène naturel qui n'altère pas le fonctionnement de l'appareil.

■ Die Schwärzung an den Kontakten und in der Lichtbogenkammer ist ein normales Phänomen und hat keine Auswirkungen auf die Funktionsweise des Gerätes.

■ L'annerimento dei contatti e delle camere spegni-arco è un fenomeno naturale che non altera il funzionamento dell'apparecchio.

■ El ennegrecimiento de los contactos y de las cámaras de arco es un fenómeno natural que no altera el funcionamiento del aparato.

■ Почернение контактов и корпусов дуги является естественным последствием нормальной работы и не влияет на функционирование изделия.

■ 触点和电弧室变黑属正常操作中的正常现象，对产品运行无任何影响。

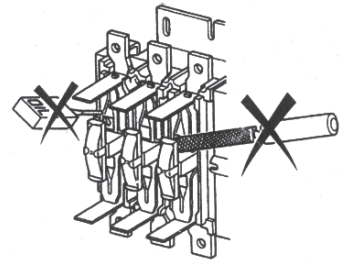
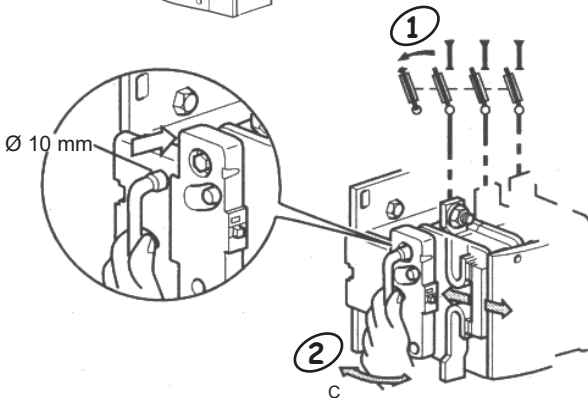
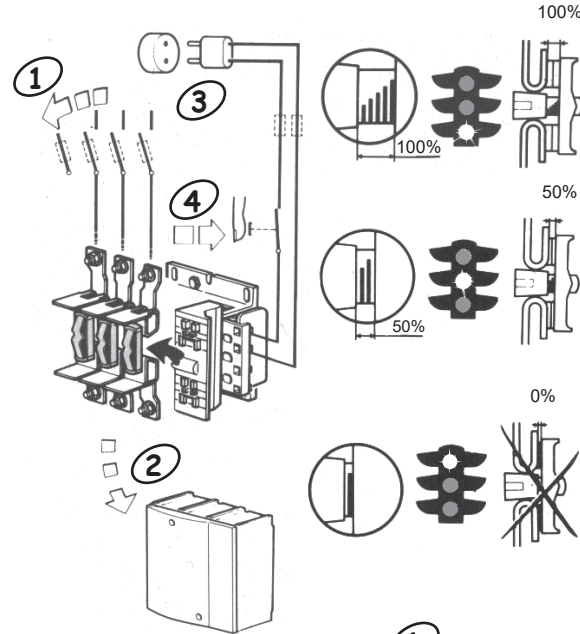

C (maxi / макс. / 最大) = 10 N.m (88.5 lb-in) for LC1F115...F225

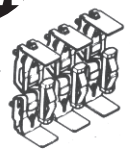

LA5 FF431 (F115/F150)
 LA5 FG431 (F185/F225)
 LA5 FH431 (F265)

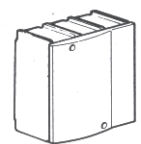

LA5 F11550 (F115)
 LA5 F15050 (F150)
 LA5 F18550 (F185)
 LA5 F22550 (F225)
 LA5 F26550 (F265)

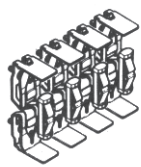

LA5 FF441 (F1154/F1504)
 LA5 FG441 (F1854/F2254)
 LA5 FH441 (F2654)

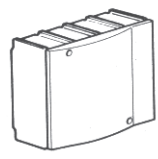

LA5 F115450 (F1154)
 LA5 F150450 (F1504)
 LA5 F185450 (F1854)
 LA5 F225450 (F2254)
 LA5 F265450 (F2654)

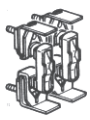

LA5 F400802 (F4002)
 LA5 F500802 (F5002)

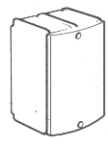

LA5 F400250 (F4002)
 LA5 F500250 (F5002)

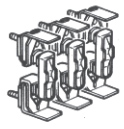

LA5 F400803 (F330/F400)
 LA5 F500803 (F500)

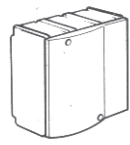

LA5 F33050 (F330)
 LA5 F40050 (F400)
 LA5 F50050 (F500)

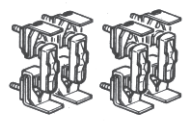

LA5 F400804 (F3304/F4004)
 LA5 F500804 (F5004)

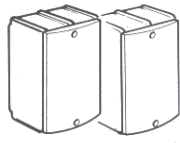

LA5 F330450 (F3304)
 LA5 F400450 (F4004)
 LA5 F500450 (F5004)

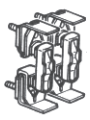

LA5 F630802 (F6302)

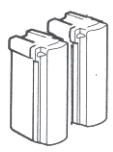

LA5 F630250 (F6302)

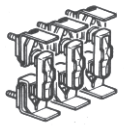

LA5 F630803 (F630)
 LA5 F800803 (F800)

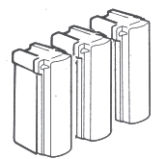

LA5 F63050 (F630)
 LA5 F80050 (F800)
 LA5 F125050 (F1250)

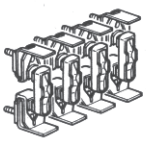

LA5 F630804 (F6304)

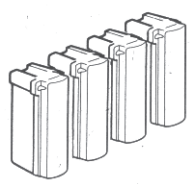

LA5 F630450 (F6304)



<p>The product's manufacture date is coded PPYYWWD, where:</p> <ul style="list-style-type: none">● PP: plant code● YY: year of manufacture● WW: week of manufacture● (D: weekday of manufacture (Monday = 1))	<p>La date de fabrication du produit est codée PPYYWWD, avec:</p> <ul style="list-style-type: none">● PP: code usine● YY: année de fabrication● WW: semaine de fabrication● (D: jour de fabrication dans la semaine (lundi = 1))	<p>Das Herstellungsdatum des Produkts ist folgendermaßen codiert: PPYYWWD. Wobei:</p> <ul style="list-style-type: none">● PP: Werkscode● YY: Herstellungsjahr● WW: Herstellungswoche● (D: Herstellungstag (Montag = 1))	<p>La data di fabbricazione del prodotto è indicata con il codice PPYYWWD, dove:</p> <ul style="list-style-type: none">● PP: codice stabilimento● YY: anno di fabbricazione● WW: settimana di fabbricazione● (D: giorno della settimana in cui il prodotto è stato fabbricato (lunedì = 1))
<p>La fecha de fabricación del producto está codificada PPYYWWD, donde:</p> <ul style="list-style-type: none">● PP: código de la planta● YY: año de fabricación● WW: semana de fabricación● (D: día de la semana de fabricación (lunes = 1))	<p>A data de fabrico do produto está sob a forma de código PPYYWWD, onde:</p> <ul style="list-style-type: none">● PP: código da fábrica● YY: ano de fabrico● WW: semana de fabrico● (D: dia da semana de fabrico (Segunda-feira = 1))	<p>Дата производства продукта закодирована в формате PPYYWWD, где:</p> <ul style="list-style-type: none">● PP: код завода● YY: год производства● WW: неделя производства● (D: день недели, когда был произведен продукт (понедельник = 1))	<p>产品制造日期采用如下代码 PPYYWWD, 其中:</p> <ul style="list-style-type: none">● PP: 工厂代码● YY: 制造年份● WW: 第几周制造● (D: 星期几制造 (星期一 = 1))



W913558170191

Schneider Electric Industries SAS

35, rue Joseph Monier
CS30323
F - 92500 Rueil-Malmaison
<http://www.schneider-electric.com>

W9 1355817 0191 20

**Уполномоченный поставщик в РФ:
АО «Шнейдер Электрик»**

Адрес:
127018, г. Москва, ул. Двинцев, д.12, корп.1,
тел. +7 (495)777 99 88,
факс: +7 (495)777 99 94, 8-800-200-6446
www.schneider-electric.ru

EAC



20/20