



MOLDED-CASE CIRCUIT BREAKERS & EARTH-LEAKAGE CIRCUIT BREAKERS 30~800A FRAME



Announcing the completion of
a full line-up of
PSS circuit breakers
for the 21st century.

PROGRESSIVE
SUPER SERIES

High Performance



Mitsubishi Electric Corporation's Fukuyama Works,
which produces these products, is certified as meeting
the ISO14001 environmental management system standard.
Certification No.: EC701128 Date of Certification: Nov. 26, 1997

CONTENTS

Contents	2~3
Introduction.....	4~5
Rapid Progress.....	6~7
Development.....	8
Evolution.....	9
Superiority.....	10
Model Naming.....	11
Series Outline.....	12
Series Ratings.....	13
Specifications	
Molded-case circuit breakers	
MCCB NF-C.....	14~15
MCCB NF-S.....	16~21
MCCB NF-U.....	22~23
Earth-leakage circuit breakers	
ELCB NV-C.....	24~25
ELCB NV-S.....	26~29
Miniature circuit breakers	
BH.....	30~33
Motor Protection	
MCCB MB.....	34
ELCB MN.....	35
Others	
ELR & ZCT.....	36~37
Circuit Protector CP.....	38
Special Purpose Breakers	
Mag Only, DC-Use and DSN-Type.....	39
400Hz-Use, Low-Instantaneous and Generator-Protection.....	40
Connection	
Types and Accessories.....	41

CONTENTS

Accessories

Internal Accessories

Cassette-Type, Built-In.....	42
MCCB Maximum number of accessories.....	43~44
ELCB Maximum number of accessories.....	45~47
New products, options, etc.....	48~53

External Accessories

Electrically operated.....	54~57
Mechanical interlocks.....	58~60
Operating handles.....	61~65
Terminal covers.....	66~67

Characteristics

MCCB.....	68~78
ELCB.....	79~83
BH.....	84~85
CP.....	86

Dimensions

MCCB.....	87~96
ELCB.....	97~104
BH.....	105

Comparison between New and Former Models

Compatibility.....	106~108
Other changes.....	109~113
Dimensions.....	114~119

Ordering Information.....	120
---------------------------	-----

Safety tip: Be sure to read the instruction manual thoroughly before using these products.

INTRODUCTION

Circuit Breakers for the 21st Century

The completion of a full line-up of PSS breakers

As the leading manufacturer of circuit breakers, Mitsubishi Electric has long developed products to fit the needs of the era. With the completion of the Progressive Super Series (PSS) circuit breakers covering 400~800 Ampere frame(AF), we can now offer a full complement of PSS models from 30~800AF. With our advanced technology and know-how, we're already anticipating the needs of the next era by producing new circuit breakers for the 21st century: PSS circuit breakers.

RAPID PROGRESS

21st century functions

Mitsubishi Electric is pioneering new technology that will take us into the 21st century. One such technology is the new digital display unit for circuit condition. In keeping with the era's needs, it permits energy management. As such, it can be justly described as a circuit breaker with a brain, a new type of intelligent breaker for the next century.

DEVELOPMENT

Ease of use

The new circuit breakers are easier to use than ever before. The module types have been simplified to just two sizes, allowing easier board design standardization and rationalization. The cassette accessories also make replacement a simple, one-touch operation.

EVOLUTION

Technology

To reflect a variety of uses and applications, the line-up has been further expanded. This new comprehensive line-up answers the demands of the era for models with high specifications for a range of purposes and applications.

SUPERIORITY

Breaker with a brain

The new digital Electronic Trip Relay (ETR), the brain of the circuit breaker, ensures accurate protection of the circuit. Using advanced digital technology, Mitsubishi has succeeded in creating a new type of electronic circuit breaker, and realized a new level of safety and reliability.

HIGH PERFORMANCE

Full Scale Progressive Super Series

**Packed with Mitsubishi's 21st century technology.
Circuit breakers with advanced intelligence are now available.**

Technology continues to evolve toward the 21st century. The consumption of electric power increases as well, demanding from circuit breakers new levels of functionality, flexibility, power- and space-saving. To answer the requirements of the era, we have realized a new level of harmony between breaker and measuring component. We have created a new generation of breakers, which are without equal to any previously produced models. Mitsubishi Electric is proud to announce the newest evolution in circuit breakers for the 21st century, combining new levels of superiority and reliability.

Progressive Super Series



Caution: Before installing these circuit breakers, it is recommended that their safe and correct usage be studied with a thorough reading of the "Handling and Maintenance" guidebook.

RAPID PROGRESS

The circuit breaker incorporates a digital Measuring Display Unit (MDU). It can measure and display a range of circuit condition data for more efficient energy management.



Display

Measuring and displaying the load current, line voltage, electric power, electric energy level, harmonic current (third, fifth, seventh and total) earth-leakage current* enables energy control.

*Earth-leakage current is used with electronic earth-leakage circuit breakers.

Monitoring

The LED lights when it monitors the following alarm output from the circuit breaker.(except for 225AF)

- PAL: Pre-alarm
- OVER: Overload alarm
- EPAL: Earth-leakage pre-alarm: setting either electronic earth-leakage circuit breakers is possible by using the switch on the MDU. When the current exceeds the preset earth-leakage level, the LED lights.

Measuring display item	225AF	400AF	630AF	800AF
Load current Present value, average value, maximum value	●	●	●	●
Line voltage Present value, average value, maximum value	●	●	●	●
Harmonic current Third, fifth, seventh total	●	●	●	●
Electric power Present value, maximum value	●	●	●	●
Electric energy accumulated Total value	●	●	●	●
Earth-leakage current Present value, average value, maximum value	●	●	●	●
Power factor Present value	●	●	●	●

Maintenance

- Measures and displays the cause, short-circuit current of the fault and the fault load current (overload current or earth-leakage current). (except for 225AF)
- Even when the control power is cut, the fault's cause and load current are saved. (except for 225AF)
- Since the maximum value of the average load current, power and time of occurrence are measured, this is helpful for locating the peak time for energy use.



Example of NV630-SEPM long-delay tripping display

Installed on the main unit.



Installed on the panel.

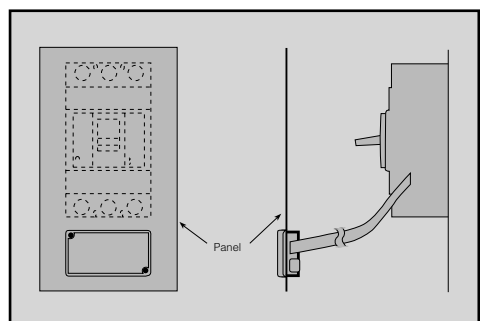

Installation

- The measuring VT and CT are installed within the circuit breaker, thus offering savings on space and wiring.
- The measuring display unit can be installed on the circuit breaker or onto the panel.

Applicable models: NF225-SPM, NV225-SPM
 NF400-SEPM/HEPM, NF630-SEPM/HEPM,
 NF800-SEPM/HEPM, NV400-SEPM/HEPM,
 NV630-SEPM/HEPM, NV800-SEPM/HEPM

DEVELOPMENT

In the pursuit of ever easier operation, the modules are now unified into just five types—allowing rationalization and standardization of the panel design.

Standardized to five module types

- PSS breakers (30~800AF) are standardized to five sizes.

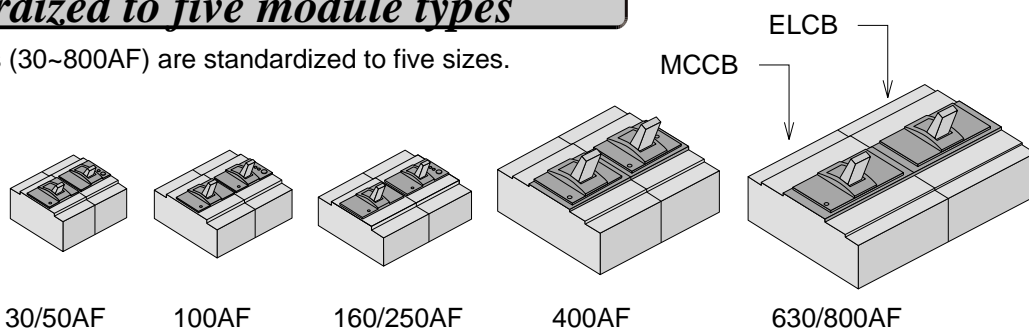

- MCCBs = ELCBs
- Thermal-magnetic type = Electric-trip relay type

Panel cut-out design unified to include 30~800A frame

- Two types of panel cut-out are available.
- All are symmetric with the center line.



Cassette-type accessories

● Cassette-type accessories ensure flexibility when upgrading circuits. Ordering is easy, and installation is one-touch simple—and safe too thanks to the insulated cassette design.

Fits all breaker series

The alarm switch (AL), auxiliary switch (AX), shunt trip (SHT), and undervoltage trip (UVT) all come as cassette-type accessories to suit all breaker series (types). Choose from two options: lead or lead-wire terminal block.

Installation

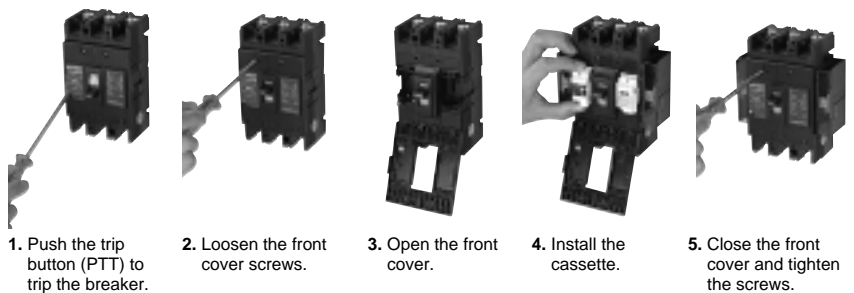

- Caution.**
- Always ensure the breaker is tripped when installing accessories.
 - Please entrust installation to an experienced person.
 - Please refer to the instruction manual in the box.

EVOLUTION

PSS now has improved performance and safety because of IEC60947-2 compliance.



●In order to conform to IEC60947-2, molded-case circuit breakers are now standard.



●Earth-leakage circuit breakers also conform to IEC60947-2

$I_{cs} = 100\%I_{cu}$

●The SP, SEP, and HEP types in the 400~800AF offer $I_{cs} = 100\%I_{cu}$.

The IEC60947-2 specifies the I_{cu} (rated ultimate short-circuit) and I_{cs} (rated service short-circuit) breaking capacities to the following two types:

I_{cu} : O-CO

I_{cs} : O-CO-CO

The rise in temperature after breaking test is also regulated.

Utilization category "B"

All electronic-type models (400~800AF) satisfy Utilization category "B". Utilization category is a regulation on application with respect to selectivity.

Utilization category A: Circuit breakers not specifically intended for selectivity under short-circuit conditions. Such breakers do not have a short-time withstand current rating.

Utilization category B: Circuit breakers specifically intended for selectivity under short-circuit conditions. Such breakers have a short-time withstand current rating.

Standardized as "Suitable for Isolation" and despatching

The load dispatching point for supply disconnecting devices is regulated according to the EC's machine directives, European Standards EN60204-1 "Electrical Components of Mechanical Equipment Part1—General Matters."

For circuit breakers, the breaker's function is suitable for isolation.

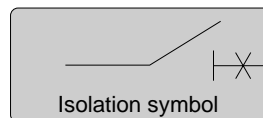

Note 1: 400~800AF are suitable for isolation (excluding 4-pole models).

Note 2: For breakers under 250AF, please contact us for details.

Class II insulation (IEC 664)

The handle is double insulated to make it safer than ever. (Even if the handle is damaged, the insulation is secure.)

SUPERIORITY

A microcomputer and Mitsubishi's original IC realize a new high level of safety

Safer and more reliable power

Digital current evaluation delivers a higher level of protection

Electronic device loads, such as inverters, distort the current waveform. Our electronic breakers use a digital detector to measure the current's effective value and minimize overload tripping errors. This enables precise protection of the circuit.

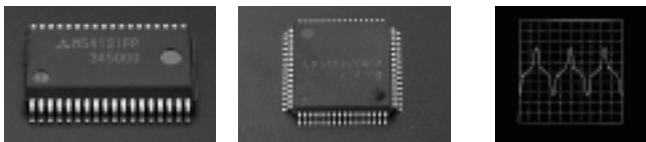

Digital current evaluation circuitry.

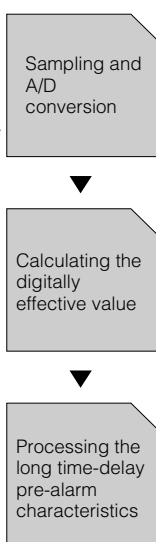
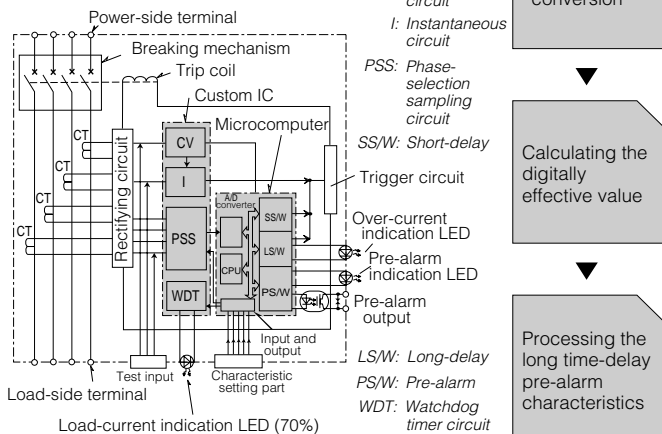

Improved protection against fluctuations in the load current

Coordinated protection from multiple (6) tripping characteristics

The user has a choice of six different items as tripping characteristics with the multiple coordinated protection method. Better protection can be obtained between high-voltage fuse, OCR and low-voltage fuse.

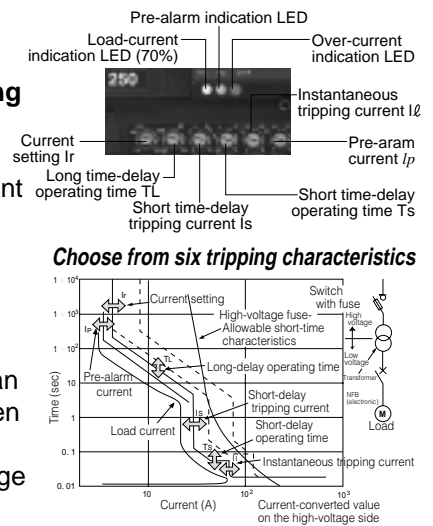

Improved protection and safety

Neutral-pole overload protection for 4-pole electronic circuit breakers

Four-pole MCCBs are equipped with a neutral-pole overload protection circuit. It prevents burn-out in a 3 ϕ 4w circuit which is prone to distorted third-harmonic current flows.

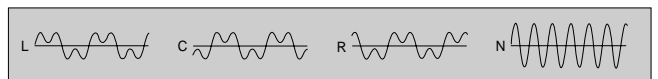

Alarm function monitors and anticipates interruptions

Standard pre-alarm system lights LED and outputs signal

PSS electronic MCCBs feature a pre-alarm function as standard. The preferential alarm predicts an overload condition in the breaker before it trips. When the load current exceeds the set pre-alarm current, it outputs a pre-alarm signal (from the solid-state relay) and lights the LED.

The pre-alarm module (with contact output) is optional with electronic molded-case and earth-leakage circuit breakers.

Portable tester facilitates checking and maintenance

The separately sold portable tester allows the user to check the four characteristics shown below on location:

1. Long-delay tripping
2. Short-delay tripping
3. Instantaneous tripping
4. Pre-alarm characteristics



LEDs for load current, pre-alarm and over-current show the operating status.

MODEL NAMING





MODEL NAMING

M C C B s		
Molded-case circuit breakers	NF-C	Economy type
	NF-S	Standard type
	NF-U	Ultra current-limiting type
BH-type miniature circuit breakers (MCBs)	BH-S/PS	NEMA type for consumer units
	BH-D	DIN type for consumer units
Motor breaker	MB	MCCB for motor protection
Circuit protector	CP	Circuit breaker for equipment





E L C B s		
Earth-leakage circuit breakers	NV-C	Economy type
	NV-S	Standard type
	NV-U	Ultra current-limiting type
Motor breaker	MN	ELCB for motor protection
Earth-leakage relay	NV-ZB	Electrical self-holding type
	NV-ZS	Mechanical self-holding type
	NV-ZU	Upstream interlock relay

SERIES OUTLINE







Molded-case circuit breakers **MCCB**

NF-C <i>Economy type</i>	NF-S <i>Standard type</i>	NF-U <i>Ultra current-limiting type</i>	MB <i>Motor breaker type</i>
			
Basic model designed for cost performance	Standard model for wide range of applications.	Current limiting-type ultra breaker.	MCCB for motor protection

Earth-leakage circuit breakers **ELCB**

NV-C <i>Economy type</i>	NV-S <i>Standard type</i>	NV-U <i>Ultra current-limiting type</i>	MN <i>Motor breaker type</i>
			
Basic model designed for cost performance	Standard model for wide range of applications.	Current limiting-type ultra breaker.	ELCB for motor protection

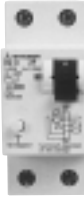
Miniature circuit breakers **MCB**

BH	BH-P	BH-S	BH-PS	BH-D6	BV-D	KB-D
						
NEMA-type for consumer unit				DIN-series for general consumer unit		

Circuit protectors **CP**

CP30-BA	CP-B	CP-S
		
For equipment		

SERIES RATINGS

Molded-case circuit breaker

AF Series	30	50	60	100	160	250	400	630	800
NF-C	NF30-CS	NF50-CP	NF60-CP	NF100-CP	—	NF250-CP	NF400-CP	NF630-CP	NF800-CEP
NF-S	NF30-SP	NF50-HP	—	NF100-SP	NF160-SP	NF250-SP	NF400-SP	NF630-SP	NF800-SDP
				NF100-SEP		NF250-SEP	NF400-SEP	NF630-SEP	NF800-SEP
		NF50-HRP	NF60-HP	NF100-HP	NF160-HP	NF250-HP	NF400-HEP	NF630-HEP	NF800-HEP
				NF100-HEP		NF250-HEP	NF400-REP	NF630-REP	NF800-REP
NF-U	—	—	—	NF100-RP	—	NF225-RP	NF400-UEP	NF630-UEP	NF800-UEP
				NF100-UP		NF225-UP			

Earth-leakage circuit breaker

AF Series	30	50	60	100	225	400	630	800
NV-C	NV30-CS	NV50-CP	NV60-CP	NV100-CP	NV225-CP	NV400-CP	NV630-CP	—
NV-S	NV30-SP	—	—	NV100-SP	NV225-SP	NV400-SP	NV630-SP	NV800-SEP
				NV100-SEP	NV225-SEP	NV400-SEP	NV630-SEP	
		NV50-HP	NV60-HP	NV100-HP	NV225-HP	NV400-HEP	NV630-HEP	NV800-HEP
				NV100-HEP	NV225-HEP	NV400-REP		
NV-U	—	—	—	NV100-RP	NV225-RP	—	—	—

Miniature circuit breaker

AF	60 and less	100 and less
BH	BH	
	BH-P	
	BH-S	—
	BH-PS	—

DIN series

AF	63 and less
MCB	BH-D6
RCCB	BV-D
Isolating Switch	KB-D

Motor breaker

AF	30	50	60	100	225
MB	MB30-SP	MB50-CP	—	MB100-SP	MB225-SP
		MB50-SP			

Motor breaker (with earth-leakage)

AF	30	50	60	100	225
MN	MN30-CS	MN50-CP	—	MN100-SP	MN225-SP
		MN50-SP			







Circuit protectors

AF	30 and less
CP	CP30-BA
	CP-B
	CP-S



SPECIFICATIONS

MOLDED-CASE CIRCUIT BREAKERS

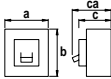
MCCBs NF-C Series (Economy type)

Frame (A)			30		50		60		100			250						
Type			NF30-CS		NF50-CP		NF60-CP		NF100-CP		NF100-CP T/A*1		NF250-CP		NF250-CP T/A*1			
Photo																		
Rated current In (A) at ambient temperature 30°C*2 (T/A: at ambient temperature 40°C)			3, 5, 10, 15, 20, 30		3, 5, 10, 15, 20, 30, 40, 50		(10) (15) (20) (30) (40) (50) 60 *5		50, 60, 75, 100		15-20, 20-25, 25-40, 40-63, 63-80, 80-100 adjustable		125, 150, 175, 200, 225, 250		100-125, 125-160, 150-200, 200-250 adjustable			
Number of poles			2 3		2 3		2 3		2 3		2 3		2 3		2 3			
Rated insulation voltage Ui (V)			AC 500		600		600		600		600		600		600			
			DC —		250 *3 —		250 *3 —		250 *3 —		—		250 *3 —		—			
Rated breaking capacity (kA)	IEC60947-2 (Icu/Ics)	AC	690V —		—		—		—		—		—		—			
			500V —		2.5/1		2.5/1		7.5/4		7.5/4		10/5		10/5			
			440V 1.5/1.5 (415V)		2.5/1		2.5/1		10/5		10/5		10/5		15/8			
			400V 1.5/1.5 (380V)		5/2		5/2		10/5		10/5		18/9		18/9			
			230V 2.5/2 (240V)		5/2		5/2		25/13		25/13		30/15		30/15			
			250V —		2.5/1 —		2.5/1 —		7.5/4 —		—		10/5 —		—			
Utilization category			A		A		A		A		A		A		A			
Reverse connection			—		●		●		●		●		●		●			
Rated impulse withstand voltage Uimp (kV)			4		6		6		6		6		6		6			
Pollution degree			2		2		2		2		2		2		2			
Dimensions (mm) 			a		45 67.5		50 75		50 75		60 90		90		105			
			b		96		130		130		155		155		165		165	
			c		52		68		68		68		68		68		68	
			ca		67		90		90		90		90		90		90	
Weight			kg		0.25 0.35		0.45 0.65		0.45 0.65		0.7 1.0		0.7 1.0		1.3 1.5			
Installation and connection	Front (F)	Screw terminal	●		●		●		●		●		● *4		● *4			
		Solderless terminal	—		—		—		●		●		●		●			
		Bus bar terminal	—		●		●		●		●		●		●			
	Rear	(B)	●		●		●		●		●		●		●			
		Flush (FP)	—		—		●		●		●		●		●			
	Plug-in	Rear (PM)	—		●		●		●		●		●		●			
Rear with auto-trip (PM-A)		—		—		—		—		—		●		●				
Front (DPM)		—		●		●		●		●		—		—				
Cassette-type accessories	Alarm switch (AL)		●		●		●		●		●		●		●			
	Auxiliary switch (AX)		●		●		●		●		●		●		●			
	Shunt trip (SHT)		—		●		●		●		●		●		●			
	Undervoltage trip (UVT)		—		●		●		●		●		●		●			
Accessory connections	With lead-wire terminal block (SLT)		●		●		●		●		●		●		●			
	With lead-wire terminal block (LT)		●		—		—		—		—		—		—			
	With flying leads		●		●		●		●		●		●		●			
Built-in accessories	Pre-alarm contact output (PAL)		—		—		—		—		—		—		—			
	—		—		—		—		—		—		—		—			
External accessories	Enclosure	Dustproof	(S)	●		●		●		●		●		●		●		
			(I)	—		●		●		●		●		●		●		
		Waterproof (W)	—		— ●		— ●		— ●		●		●		●		●	
	Electrical operation device (MD)		—		—		—		— ●		●		●		●		●	
	Mechanical interlock (MI)		—		●		●		●		●		●		●		●	
	Handle lock device	Handle lock	(HL)	—		●		●		●		●		●		●		
			(HL-S)	—		●		●		●		●		●		●		
		Lock cover (LC)	●		●		●		●		●		●		●		●	
	External operating handle	Door mounting	(V)	—		—		—		●		●		●		●		
			(S)	—		●		●		●		●		●		●		
			(SS)	—		●		●		●		●		●		●		
			(F)	—		—		—		●		●		●		●		
	Insulating barrier	Between phase (BA-F)	—		●		●		●		●		●		●		●	
			To ground (BA-G)	—		●		●		●		●		●		●		
	Terminal cover	Large (TC-L)	●		●		●		●		●		●		●		●	
			Small (TC-S)	●		●		●		●		●		●		●		
		Transparent (TTC)	●		●		●		●		●		●		●			
		For rear connection (BTC)	●		●		●		●		●		●		●			
For plug-in (PTC)		—		●		●		●		●		●		●				
Adapter for IEC 35mm rail			●		●		●		●		●		—		—			
Marine approval (NK, etc.)			●		●		●		●		—		—		—			
Automatic tripping device			Hydraulic-magnetic		Hydraulic-magnetic		Hydraulic-magnetic		Thermal, magnetic		Thermal, magnetic		Thermal, magnetic		Thermal, magnetic			
Trip button			—		—		—		—		—		—		Equipped			

* 1. T/A Thermal adjustable.
 * 2. Rating at 40°C is also available. Please specify when ordering.
 * 3. Specify if for DC use.
 * 4. Bolt terminal.
 * 5. NF60-CP with an ampere rating of 50A and below have the same construction as NF50-CP.

Frame (A)		400		630		800	
Type		NF400-CP		NF630-CP		NF800-CEP	
Photo							
Rated current In (A) at ambient temperature 40°C		250, 300, 350, 400		500, 600, 630		400-800 adjustable	
Number of poles		2 3		2 3		3	
Rated insulation voltage Ui (V)		AC		600		600	
		DC		250 *1		250 *1	
Rated breaking capacity (kA)	IEC60947-2 (Icu/Ics)	AC	690V	—	—	—	
			500V	15/8	18/9	18/9	
			440V	25/13	36/18	36/18	
			415V	36/18	36/18	36/18	
			400V	36/18	36/18	36/18	
			380V	40/20	40/20	40/20	
			230V	50/25	50/25	50/25	
			DC	250V	20/10	—	20/10
Utilization category		A		A		B	
Rated short-time withstand current Icw (kA)		—		—		9,6	
Rated impulse withstand voltage Uimp (kV)		8		8		8	
Pollution degree		3		3		3	
Reverse connection		●		●		●	
Dimensions (mm)		a		140		210	
		b		257		275	
		c		103		103	
		ca		134		155	
		Weight (kg)		4.7 5.5		8.0 9.4	
Installation and connection	Front (F)	Screw terminal	—	—	—		
		Solderless terminal	●	●	●		
		Bus bar terminal	●	●	●		
	Rear	(B)	●	●	●		
		(FP)	●	●	●		
	Plug-in	Rear (PM)	●	●	●		
		Rear front IP20 with auto-trip (PM-A)	—	—	—		
Rear front IP20 with "ON-lock" (PM-L)		—	—	—			
	Front (DPM)	—	—	—			
Cassette-type accessories	Alarm switch (AL)	●	●	●			
	Auxiliary switch (AX)	●	●	●			
	Shunt trip (SHT)	●	●	●			
	Undervoltage trip (UVT)	●	●	●			
Accessory connections	With lead-wire terminal block (SLT)	●	●	●			
	With flying leads	●	●	●			
Built-in accessories	Pre-alarm contact output (PAL)	—	—	● *2			
	Trip Indicator (TI)	—	—	●			
External accessories	Enclosure	Dustproof (I)	●	●	●		
		Waterproof (W)	●	●	●		
	Electrical operation device	Motor-operated type (MD)	●	●	●		
		Spring-charge type (MDS)	●	●	●		
	Mechanical interlock (MI)	●	●	●			
	Handle lock device	Handle lock (HL)	●	●	●		
		Lock cover (LC)	—	—	—		
	External operating handle	(V)	●	●	●		
		Door mounting (S)	●	●	●		
		(SS)	●	●	●		
		Mounted on breaker (R)	●	●	●		
	Insulating barrier	Between phase (BA-F)	●	●	●		
		To ground (BA-G)	●	●	●		
	Terminal cover	Large (TC-L)	●	●	●		
		Small (TC-S)	—	—	—		
		Transparent (TTC)	●	●	●		
		For rear connection (BTC)	●	●	●		
		For plug-in (PTC)	●	—	—		
		Adapter for IEC35mm rail	—	—	—		
	Marine approval (NK, etc.)	●	●	●			
Automatic tripping device	Thermal, magnetic	Thermal, magnetic	Electronic				
Trip button	—	Equipped	—				







*1. Specify if for DC use.

*2. Solid state relay output is standard. Please specify if contact output is necessary. (Standard type is thus SLT equipped.)

SPECIFICATIONS

MOLDED-CASE CIRCUIT BREAKERS

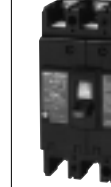





MCCBs NF-S Series (Standard type)

Frame (A)			30			50			60			100														
Type			NF30-SP			NF50-HP			NF50-HRP			NF60-HP			NF100-SP			NF100-SP T/A*1								
Photo																										
Rated current In (A) at ambient temperature 30°C*2 (T/A: at ambient temperature 40°C)			3, 5, 10, 15, 20, 30			10, 15, 20, 30, 40, 50			15, 20, 30, 40, 50			(10) (15) (20) (30) (40) (50) 60 *4			15, 20, 30, 40, 50, 60, 75, 100			15-20, 20-25, 25-40, 40-63, 63-80, 80-100 adjustable								
Number of poles			2 3			2 3 4			2 3			2 3 4			2 3 4			2 3 4								
Rated insulation voltage Ui (V)			AC 600			600			690			600			690			690								
			DC 250*3			—			250*3			—			250*3			—			—					
Rated breaking capacity (kA) IEC60947-2 (Icu/Ics)			AC			690V			—			2.5/1			—			—			—					
						500V			2.5/1			7.5/4			20/10			7.5/4			15/8			15/8		
						440V			2.5/1			10/5			30/15			10/5			25/13			25/13		
						400V			5/2			10/5			30/15			10/5			30/15			30/15		
						230V			5/2			25/13			85/43			25/13			50/25			50/25		
DC			250V			2.5/1			—			7.5/4			—			15/8			—					
Utilization category			A			A			A			A			A			A								
Reverse connection			●			●			●			●			●			●								
Rated impulse withstand voltage Uimp (kV)			6			6			6			6			6			6								
Pollution degree			2			2			2			2			2			2								
Dimensions (mm)			a			50 75			50 75 100			90			50 75 100			60 90 120			90 120					
			b			130			130			155			130			155			155					
			c			68			68			68			68			68			68					
			ca			90			90			90			90			90			90					
Weight			kg 0.45 0.65			0.55 0.75 1.0			0.8 1.1			0.55 0.75 1.0			0.75 1.1 1.4			0.75 1.1 1.4								
Installation and connection			Front (F)			Screw terminal			●			●			●			●			●					
						Solderless terminal			—			—			—			—			—					
						Bus bar terminal			●			●			●			●			●					
			Rear (B)			Flush (FP)			●			●			●			●			●					
						Rear (PM)			●			●			●			●			●					
						Rear with auto-trip (PM-A)			—			—			—			—			—					
Plug-in			Front (DPM)			●			●			●			●			●								
			—			—			—			—			—			—								
Cassette-type accessories			Alarm switch (AL)			●			●			●			●			●								
			Auxiliary switch (AX)			●			●			●			●			●								
			Shunt trip (SHT)			●			●			●			●			●								
			Undervoltage trip (UVT)			●			●			●			●			●								
Accessory connections			With lead-wire terminal block (SLT)			●			●			●			●			●								
			With flying leads			●			●			●			●			●								
Built-in accessories			Pre-alarm contact output (PAL)			—			—			—			—			—								
External accessories			Enclosure			(S)			●			●			●			●								
						(I)			●			●			●			●			●					
			Waterproof (W)			— ●			— ●			— ●			— ●			— ●								
			Electrical operation device (MD)			—			—			●			—			●								
			Mechanical interlock (MI)			●			●			●			●			●								
			Handle lock device			Handle lock (HL)			●			●			●			●								
						Handle lock (HL-S)			●			●			●			●								
						Lock cover (LC)			●			●			●			●								
			External operating handle			(V)			—			●			—			●								
						(S)			●			●			●			●								
						(SS)			●			●			●			●								
						(F)			—			●			—			●								
			Insulating barrier			Between phase (BA-F)			●			●			●			●								
						To ground (BA-G)			●			●			●			●								
			Terminal cover			Large (TC-L)			●			●			●			●								
						Small (TC-S)			●			●			●			●								
Transparent (TTC)						●			●			●			●											
For rear connection (BTC)						●			●			●			●											
For plug-in (PTC)			●			●			●			●														
Adapter for IEC 35mm rail			●			●			●			●			●											
Marine approval (NK, etc.)			●			●			●			●			●											
Automatic tripping device			Hydraulic-magnetic			Hydraulic-magnetic			Thermal, magnetic			Hydraulic-magnetic			Thermal, magnetic			Thermal, magnetic								
Trip button			—			—			—			—			—			—								

* 1. T/A Thermal adjustable.
 * 2. Rating at 40°C is also available. Please specify when ordering.
 * 3. Specify if for DC use.
 * 4. NF60-HP with an ampere rating of 50A and below have the same construction as NF50-HP

SPECIFICATIONS

MOLDED-CASE CIRCUIT BREAKERS

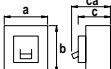
Frame (A)		100												160												
Type		NF100-SEP			NF100-HP			NF100-HP T/A*1			NF100-HEP			NF160-SP			NF160-SP T/A*1			NF160-HP						
Photo																										
Rated current In (A) at ambient temperature 30°C*2 (T/A: at ambient temperature 40°C)		(15-20) 30-50, 60-100 adjustable			15,20,30, 40,50, 60, 75,100			15-20,20-25,25-40, 40-63, 63-80, 80-100 adjustable			(15-20), 30-50, 60-100 adjustable			(50), (60), (75), (100), 125,150 160			(63-80),100-125, (80-100),125-160 adjustable			(50), (60), (75), (100), 125,150 160						
Number of poles		3 4			2 3 4			2 3 4			3 4			2 3 4			2 3 4			2 3 4						
Rated insulation voltage Ui (V)		AC 690			690			690			690			690			690			690						
		DC —			250*3			—			—			250*3			—			250*3						
Rated breaking capacity (kA)		IEC60947-2 (Icu/Ics)		AC		690V —			5/3			— (5/3)*5			5/3			—			—			5/3		
						500V 15/8			30/15			30/15			30/15			15/8			15/8			30/8		
						440V 25/13			50/25			50/25			50/25			25/13			25/13			50/13		
						400V 30/15			50/25			50/25			50/25			30/15			30/15			50/13		
						230V 50/25			100/50			100/50			100/50			50/25			50/25			100/25		
DC		250V —			40/20			—			—			15/8			—			40/20						
Utilization category		A			A			A			A			A			A			A						
Reverse connection		●			●			●			●			●			●			●						
Rated impulse withstand voltage Uimp (kV)		6			6			6			6			6			6			6						
Pollution degree		2			2			2			2			2			2			2						
Dimensions (mm)				a 90 120			90 120			90 120			90 120			105 140			105 140			105 140				
				b 155			155			155			155			165			165			165				
				c 68			68			68			68			68			68			68				
				ca 90			90			90			90			92			92			92				
Weight		Kg 1.2 1.5			0.75 1.1 1.4			0.75 1.1 1.4			1.2 1.5			1.3 1.5 1.9			1.3 1.5 1.9			1.3 1.5 1.9						
Installation and connection		Fixed		Front (F)		Screw terminal ●			●			●			● *4			● *4			● *4					
				Solderless terminal ●		●			●			●			●			●								
				Bus bar terminal ●		●			●			●			●			●								
		Rear		(B) ●		●			●			●			●			●								
				Flush (FP) ●		●			●			●			●			●								
				Plug-in		Rear (PM) ●		●			●			●			●									
Rear with auto-trip (PM-A) —		—			—			—			●			●												
Front (DPM) —		●			—			—			—			—												
Cassette-type accessories		Alarm switch (AL) ●		●			●			●			●			●										
		Auxiliary switch (AX) ●		●			●			●			●			●										
		Shunt trip (SHT) ●		●			●			●			●			●										
		Undervoltage trip (UVT) ●		●			●			●			●			●										
Accessory connections		With lead-wire terminal block (SLT) ●		●			●			●			●			●										
		With flying leads ●		●			●			●			●			●										
Built-in accessories		Pre-alarm contact output (PAL) ● *6		—			—			● *6			—			—										
External accessories		Enclosure		Dustproof (S) ●		—			●			—			●			—								
				(I) ●		—			●			—			●			—								
				Waterproof (W) ●		—			●			—			●			—								
		Electrical operation device (MD) ●		●			●			●			●			●										
		Mechanical interlock (MI) ●		●			●			●			●			●										
		Handle lock device		Handle lock (HL) ●		●			●			●			●			●								
				(HL-S) ●		●			●			●			●			●								
				Lock cover (LC) ●		●			●			●			●			●								
		External operating handle		Door mounting (V) ●		●			●			●			●			●								
				(S) ●		●			●			●			●			●								
				(SS) ●		●			●			●			●			●								
				Mounted on breaker (R) ●		●			●			●			●			●								
		(F) ●		●			●			●			●			●										
		Insulating barrier		Between phase (BA-F) ●		●			●			●			●			●								
				To ground (BA-G) ●		●			●			●			●			●								
		Terminal cover		Large (TC-L) ●		●			●			●			●			●								
Small (TC-S) ●				—			●			—			●			—										
Transparent (ITC) ●				—			●			—			●			—										
For rear connection (BTC) ●				—			●			—			●			—										
For plug-in (PTC) ●		—			●			—			●			—												
Adapter for IEC 35mm rail ●		—			●			—			●			—												
Marine approval (NK, etc.)		—			●			—			●			—												
Automatic tripping device		Electric			Thermal, magnetic			Thermal, magnetic			Electronic			Thermal, magnetic			Thermal, magnetic									
Trip button		—			—			—			—			—			—									

* 1. T/A Thermal adjustable.

* 2. Rating at 40°C is also available. Please specify when ordering.

* 3. Specify if for DC use.

* 4. Bolt terminal.







* 5. To be agreed soon.

* 6. Solid state relay output is standard. Please specify if other output is necessary. (Standard type is thus SLT equipped.)





SPECIFICATIONS

MOLDED-CASE CIRCUIT BREAKERS

MCCBs NF-S Series (Standard type)

Frame (A)		160			250													
Type		NF160-HP T/A*1	NF250-SP	NF250-SP T/A*1	NF250-SEP	NF250-HP	NF250-HP T/A*1	NF250-HEP										
Photo																		
Rated current In (A) at ambient temperature 30°C*2 (T/A: at ambient temperature 40°C)		(63~80), 100~125, (80~100), 125~160 adjustable	125, 150, 175, 200, 225, 250	100~125, 125~160, 150~200, 200~250 adjustable	125~250 adjustable	125, 150, 175, 200, 225, 250	100~125, 125~160, 150~200, 200~250 adjustable	125~250 adjustable										
Number of poles		2 3 4	2 3 4	2 3 4	3 4	2 3 4	2 3 4	3 4										
Rated insulation voltage Ui (V)		690																
AC		250*3																
DC		—																
Rated breaking capacity (kA)	IEC60947-2 (Icu/Ics)	AC	690V	— (10/5) *5		—		—		250*3		—		—		—		
			500V	30/8 (30/15) *5		15/8		15/8		15/8		5/3		— (10/5) *5		5/3		
			440V	50/13 (50/25) *5		25/13		25/13		25/13		50/13		50/13 (50/25) *5		50/13		
			400V	50/13 (50/25) *5		30/15		30/15		30/15		50/13		50/13 (50/25) *5		50/13		
			230V	100/25 (100/50) *5		50/25		50/25		50/25		100/25		100/25 (100/50) *5		100/25		
DC		250V	—		15/8		—		—		40/20		—		—			
Utilization category		A																
Reverse connection		●																
Rated impulse withstand voltage Uimp (kV)		6																
Pollution degree		2																
Dimensions (mm)		a		b		c		ca		a		b		c		ca		
		105	140	105	140	105	140	105	140	105	140	105	140	105	140	105	140	
		165	165	165	165	165	165	165	165	165	165	165	165	165	165	165	165	
		68	68	68	68	68	68	68	68	68	68	68	68	68	68	68	68	
		92	90	92	92	92	92	92	92	92	92	92	92	92	92	92	92	
Weight		Kg		1.3	1.5	1.9	1.3	1.5	1.9	1.3	1.5	1.9	1.3	1.5	1.9	1.6	2.1	
Installation and connection	Fixed (F)	Screw terminal	● *4		● *4		● *4		● *4		● *4		● *4		● *4		● *4	
		Solderless terminal	●		●		●		●		●		●		●		●	
		Bus bar terminal	●		●		●		●		●		●		●		●	
	Rear (R)	(B)	●		●		●		●		●		●		●		●	
		(FP)	●		●		●		●		●		●		●		●	
Plug-in (P)	Rear (PM)	●		●		●		●		●		●		●		●		
	Rear with auto-trip (PM-A)	●		●		●		●		●		●		●		●		
	Front (DPM)	—		—		—		—		—		—		—		—		
Cassette-type accessories		Alarm switch (AL)	●		●		●		●		●		●		●		●	
		Auxiliary switch (AX)	●		●		●		●		●		●		●		●	
		Shunt trip (SHT)	●		●		●		●		●		●		●		●	
		Undervoltage trip (UVT)	●		●		●		●		●		●		●		●	
Accessory connections		With lead-wire terminal block (SLT)	●		●		●		●		●		●		●		●	
		With flying leads	●		●		●		●		●		●		●		●	
Built-in accessories		Pre-alarm contact output (PAL)	—		—		—		● *6		—		—		—		● *6	
External accessories	Enclosure	Dustproof (S)	—		●		—		●		—		●		—		—	
		(I)	●		—		●		—		●		—		●		—	
		Waterproof (W)	●		—		●		—		●		—		●		—	
	Electrical operation device (MD)		●		●		●		●		●		●		●		●	
	Mechanical interlock (MI)		●		●		●		●		●		●		●		●	
	Handle lock device	Handle lock (HL)	●		●		●		●		●		●		●		●	
		(HL-S)	●		●		●		●		●		●		●		●	
		Lock cover (LC)	●		●		●		●		●		●		●		●	
	External operating handle	(V)	●		●		●		●		●		●		●		●	
		Door mounting (S)	●		●		●		●		●		●		●		●	
		(SS)	●		●		●		●		●		●		●		●	
	Insulating barrier	Mounted on breaker (R)	●		●		●		●		●		●		●		●	
		(F)	●		●		●		●		●		●		●		●	
	Terminal cover	Between phase (BA-F)	●		●		●		●		●		●		●		●	
		To ground (BA-G)	●		●		●		●		●		●		●		●	
Large (TC-L)		●		●		●		●		●		●		●		●		
Small (TC-S)		●		—		●		—		●		—		●		—		
Transparent (TTC)		●		—		●		—		●		—		●		—		
Adapter for IEC 35mm rail	For rear connection (BTC)	●		—		●		—		●		—		●		—		
	For plug-in (PTC)	●		—		●		—		●		—		●		—		
Marine approval (NK, etc.)		—																
Automatic tripping device		Thermal, magnetic		Thermal, magnetic		Thermal, magnetic		Electronic		Thermal, magnetic		Thermal, magnetic		Electronic				
Trip button		Equipped																

* 1. T/A Thermal adjustable.
 * 2. Rating at 40°C is also available. Please specify when ordering.
 * 3. Specify if for DC use.
 * 4. Bolt terminal.
 * 5. To be agreed soon.
 * 6. Solid state relay output is standard. Please specify if other output is necessary. (Standard type is thus SLT equipped.)

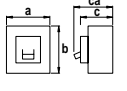
Frame (A)		400													
Type		NF400-SP			NF400-SEP			NF400-HEP			NF400-REP				
Photo															
Rated current In (A) at ambient temperature 40°C		250, 300, 350, 400			200~400 adjustable			200~400 adjustable			200~400 adjustable				
Number of poles		2	3	4	3	4	3	4	3	4	3	4			
Rated insulation voltage Ui (V)		AC 690			690			690			690				
		DC 250 *1			—			—			—				
Rated breaking capacity (kA)	IEC60947-2 (Icu/Ics)	AC	690V	10/10 (5/5) *3			10/10 (5/5) *3			10/10			15/10		
			500V	30/30 (25/25) *3			30/30 (25/25) *3			50/50			70/35		
			440V	42/42 (36/36) *3			42/42 (36/36) *3			65/65			125/63		
			415V	45/45 (36/36) *3			45/45 (36/36) *3			70/70			125/63		
			400V	45/45 (36/36) *3			45/45 (36/36) *3			70/70			125/63		
			380V	50/50 (42/42) *3			50/50 (42/42) *3			70/70			125/63		
			230V	85/85 (65/65) *3			85/85 (65/65) *3			100/100			150/75		
			DC	250V	40/40	—	—			—			—		
Utilization category		A			B			B			B				
Rated short-time withstand current Icw (kA)		—			5			5			5				
Rated impulse withstand voltage Uimp (kV)		8			8			8			8				
Pollution degree		3			3			3			3				
Reverse connection		●			●			●			●				
Dimensions (mm)			a	140	185	140	185	140	185	140	185	140			
			b	257			257			257			257		
			c	103			103			103			103		
			ca	155			155			155			155		
			Weight	(kg)	4.9	5.7	7.5	6	7.8	6	7.8	6	7.8	6	
Installation and connection	Front (F)	Screw terminal	—			—			—			—			
		Solderless terminal	●			●			●			●			
		Bus bar terminal	●			●			●			●			
	Rear (R)	(B)	●			●			●			●			
		Flush (FP)	●			●			●			●			
	Plug-in	Rear	(PM)	●			●			●			●		
Rear front IP20 with auto-trip (PM-A)			—			—			—			—			
Rear front IP20 with "ON-lock" (PM-L)			—			—			—			—			
Front	(DPM)	—			—			—			—				
Cassette-type accessories	Alarm switch (AL)	●			●			●			●				
	Auxiliary switch (AX)	●			●			●			●				
	Shunt trip (SHT)	●			●			●			●				
	Undervoltage trip (UVT)	●			●			●			●				
Accessory connections	With lead-wire terminal block (SLT)	●			●			●			●				
	With flying leads	●			●			●			●				
Built-in Accessories	Pre-alarm contact output (PAL-M)	—			● *2			● *2			● *2				
External accessories	Enclosure	Dustproof (S)	—			—			—			—			
		Waterproof (W)	●			●			●			●			
	Electrical operation device	Motor-operated type (MD)	●			●			●			●			
		Spring-charge type (MDS)	●			●			●			●			
	Mechanical interlock	(M)	●			●			●			●			
		Handle lock device	Handle lock (HL)	●			●			●			●		
			Lock cover (HL-S)	●			●			●			●		
	External operating handle	Lock cover (LC)	—			—			—			—			
		Door mounting	(V)	●			●			●			●		
			(S)	●			●			●			●		
			(SS)	●			●			●			●		
		Mounted on breaker (R)	●			●			●			●			
	(F)	●			●			●			●				
	Insulating barrier	Between phase (BA-F)	●			●			●			●			
		To ground (BA-G)	●			●			●			●			
Terminal cover	Large (TC-L)	●			●			—			—				
	Small (TC-S)	—			—			—			—				
	Transparent (TTC)	●			●			●			●				
	For rear connection (BTC)	●			●			—			●				
	For plug-in (PTC)	●			●			●			●				
Adapter for IEC35mm rail		—			—			—			—				
Marine approval (NK, etc.)		●			●			●			●				
Automatic tripping device		Thermal, magnetic			Electronic			Electronic			Electronic				
Trip button		—			Equipped			—			—				

*1. Specify if for DC use.





*2. Solid state relay output is provided in standard. Please specify if other output is necessary. (Standard type is thus SLT equipped.)

*3. In case of solderless terminal, interrupting capacity reduces: (/).

SPECIFICATIONS



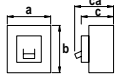

MOLDED-CASE CIRCUIT BREAKERS

MCCBs NF-S Series (Standard type)

Frame (A)		630												
Type		NF630-SP			NF630-SEP			NF630-HEP			NF630-REP			
Photo														
Rated current I _n (A) at ambient temperature 40°C		500, 600, 630			300~630 adjustable			300~630 adjustable			300~630 adjustable			
Number of poles		2	3	4	3	4	3	4	3	4	3	4		
Rated insulation voltage U _i (V)		AC 690			690			690			690			
		DC 250 *1			—			—			—			
Rated breaking capacity (kA)	IEC60947-2 (Icu/Ics)	AC	690V	10/10	10/10	10/10	15/15	20/15						
			500V	30/30	30/30	30/30	50/50	70/35						
			440V	42/42	42/42	42/42	65/65	125/63						
			415V	45/45	45/45	45/45	70/70	125/63						
			400V	45/45	45/45	45/45	70/70	125/63						
			380V	50/50	50/50	50/50	70/70	125/63						
			230V	85/85	85/85	100/100	150/75							
			DC 250V	40/40	—	—	—							
Utilization category		A			B			B			B			
Rated short-time withstand current I _{sw} (kA)		—			7.6			7.6			7.6			
Rated impulse withstand voltage U _{imp} (kV)		8			8			8			8			
Pollution degree		3			3			3			3			
Reverse connection		●			●			●			●			
Dimensions (mm)				a	210	280	210	280	210	280	210	280		
		b	275	275	275	275	275							
		c	103	103	103	103	103							
		ca	155	155	155	155	155							
Weight		(kg) 8.5 9.5 12.5			10.5 13.6			10.5 13.6			10.5			
Installation and connection	Front (F)	Screw terminal	—			—			—			—		
		Solderless terminal	●			●			●			●		
		Bus bar terminal	●			●			●			●		
	Rear	(B)	●			●			●			●		
		Flush (FP)	●			●			●			●		
	Plug-in	Rear (PM)	●			●			●			●		
		Rear front IP20 with auto-trip (PM-A)	—			—			—			—		
		Rear front IP20 with "ON-lock" (PM-L)	—			—			—			—		
Front (DPM)		—			—			—			—			
Cassette-type accessories	Alarm switch (AL)	●			●			●			●			
	Auxiliary switch (AX)	●			●			●			●			
	Shunt trip (SHT)	●			●			●			●			
	Undervoltage trip (UVT)	●			●			●			●			
Accessory connections	With lead-wire terminal block (SLT)	●			●			●			●			
	With flying leads	●			●			●			●			
Built-in Accessories	Pre-alarm contact output (PAL)	—			●*2			●*2			●*2			
	Trip indicator (TI)	—			●			●			●			
External accessories	Enclosure	Dustproof (I)	●			●			●			●		
		Waterproof (W)	●			●			●			●		
	Electrical operation device	Motor-operated type (MD)	●			●			●			●		
		Spring-charge type (MDS)	●			●			●			●		
	Mechanical interlock (MI)		●			●			●			●		
	Handle lock device	Handle lock (HL)	●			●			●			●		
		Lock cover (HL-S)	●			●			●			●		
	External operating handle	Lock cover (LC)	—			—			—			—		
		(V)	●			●			●			●		
	Insulating barrier	Door mounting (S)	●			●			●			●		
		(SS)	●			●			●			●		
		(R)	●			●			●			●		
	Terminal cover	(F)	●			●			●			●		
		Between phase (BA-F)	●			●			●			●		
		To ground (BA-G)	●			●			●			●		
		Large (TC-L)	●			●			●			●		
	Adapter for IEC35mm rail	Small (TC-S)	—			—			—			—		
		Transparent (TTC)	●			●			●			●		
		For rear connection (BTC)	●			●			●			●		
		For plug-in (PTC)	—			—			—			—		
Marine approval (NK, etc.)	●			●			●			●				
Automatic tripping device	Thermal, magnetic			Electronic			Electronic			Electronic				
Trip button	Equipped													

*1. Specify if for DC use.

*2. Solid state relay output is standard. Please specify if other output is necessary. (Standard type is thus SLT equipped.)

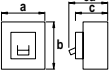
Frame (A)		800					
Type		NF800-SDP	NF800-SEP	NF800-HEP	NF800-REP		
Photo							
Rated current In (A) at ambient temperature 40°C		(700), 800	400~800 adjustable	400~800 adjustable	400~800 adjustable		
Number of poles		2	3 4	3 4	3		
Rated insulation voltage Ui (V)		AC — DC 250 *1	690 —	690 —	690 —		
Rated breaking capacity (kA)	IEC60947-2 (Icu/Ics)	AC	690V	10/10	15/15	20/15	
			500V	—	30/30	50/50	70/35
			440V	—	42/42	65/65	125/63
			415V	—	45/45	70/70	125/63
			400V	—	45/45	70/70	125/63
			380V	—	50/50	70/70	125/63
			230V	—	85/85	100/100	150/75
DC		250V	40/40	—	—		
Utilization category		A	B	B	B		
Rated short-time withstand current Icw (kA)		—	9.6	9.6	9.6		
Rated impulse withstand voltage Uimp (kV)		8	8	8	8		
Pollution degree		3	3	3	3		
Reverse connection		●	●	●	●		
Dimensions (mm)		a	210	210 280	210 280	210	
		b	275	275	275	275	
		c	103	103	103	103	
		ca	155	155	155	155	
Weight (kg)		9	10.9 14.2	10.9 14.2	10.9		
Installation and connection	Front (F)	Screw terminal	—	—	—	—	
		Solderless terminal	●	●	—	—	
		Bus bar terminal	●	●	●	●	
	Rear	(B)	●	●	●	●	
		Flush (FP)	●	●	●	●	
	Plug-in	Rear (PM)	●	●	●	●	
Rear front IP20 with auto-trip (PM-A)		—	—	—	—		
Rear front IP20 with "ON-lock" (PM-L)		—	—	—	—		
Front (DPM)	—	—	—	—			
Cassette-type accessories	Alarm switch (AL)	●	●	●	●		
	Auxiliary switch (AX)	●	●	●	●		
	Shunt trip (SHT)	●	●	●	●		
	Undervoltage trip (UVT)	●	●	●	●		
Accessory connections	With lead-wire terminal block (SLT)	●	●	●	●		
	With flying leads	●	●	●	●		
Built-in Accessories	Pre-alarm contact output (PAL)	—	● *2	● *2	● *2		
	Trip indicator (TI)	—	●	●	●		
External accessories	Enclosure	Dustproof (S)	—	—	—	—	
		(I)	●	● —	—	—	
	Waterproof (W)	(I)	●	● —	—	—	
		(W)	●	● —	—	—	
	Electrical operation device	Motor-operated type (MD)	●	●	●	●	
		Spring-charge type (MDS)	●	●	●	●	
	Mechanical interlock (MI)	●	●	●	●		
	Handle lock device	Handle lock (HL)	●	●	●	●	
		(HL-S)	●	●	●	●	
	Lock cover (LC)	(LC)	—	—	—	—	
		(V)	●	●	●	●	
	External operating handle	Door mounting	(S)	●	●	●	
			(SS)	●	●	●	
		Mounted on breaker	(R)	●	●	●	
			(F)	●	●	●	
	Insulating barrier	Between phase (BA-F)	●	●	●		
		To ground (BA-G)	●	●	●		
	Terminal cover	Large (TC-L)	●	●	—	—	
		Small (TC-S)	—	—	—	—	
		Transparent (TTC)	●	●	●	●	
For rear connection (BTC)		●	●	●	●		
For plug-in (PTC)		—	—	—	—		
Adapter for IEC35mm rail	—	—	—	—			
Marine approval (NK, etc.)	—	●	—	●	●		
Automatic tripping device	Thermal, magnetic	—	Electronic	Electronic	Electronic		
Trip button	—	—	Equipped	—	—		



*1. Specify if for DC use.

*2. Solid state relay output is standard. Please specify if other output is necessary. (Standard type is thus SLT equipped.)

SPECIFICATIONS

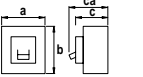

MOLDED-CASE CIRCUIT BREAKERS

MCCBs NF-U Series (Ultra current-limiting type)

Frame (A)			100						225																
Type			NF100-RP			NF100-UP			NF225-RP			NF225-UP													
Photo																									
Rated current I _n (A) at ambient temperature 30°C *1			15,20,30, 40,50,60, 75,100			15,20,30, 40,50,60, 75,100			125, 150,175, 200,225			125, 150,175, 200,225													
Number of poles			2		3		2		3		4		2		3		4								
Rated insulation voltage U _i (V)			AC			690			690			690			690										
			DC			250 *2			—			250 *2			—			—							
Rated breaking capacity (kA)	IEC60947-2 (Icu/Ics)	AC	690V			—			10/5			—			10/5										
			500V			42/42			200/200			42/42			200/200										
			440V			125/125			200/200			125/125			200/200										
			400V			125/125			200/200			125/125			200/200										
			230V			125/125			200/200			125/125			200/200										
			DC			250V			40/40			—			—										
Utilization category			A			A			A			A													
Reverse connection			●			●			●			●													
Rated impulse withstand voltage U _{imp} (kV)			6			6			6			6													
Pollution degree			2			2			2			2													
Dimensions (mm)						a			90		90		120		105			105		140					
			b			216			216			240			240										
			c			68			68			68			68										
			ca			90			90			92			92										
Weight			kg			1.7		1.8		1.7		1.8		2.5		3.0		3.2		3.0		3.2		4.0	
Installation and connection	Fixed	Front (F)	Screw terminal			●			●			● *3			● *3										
			Solderless terminal			●			●			●			●										
			Bus bar terminal			●			●			●			●										
	Rear	(B)			●			●			●			●											
		(FP)			●			●			●			●											
	Plug-in	Rear	(PM)			●			●		—		●			●		—							
			Rear with auto-trip (PM-A)			—			—			—			—										
Front		(DPM)			—			—			—			—											
Cassette-type accessories	Alarm switch (AL)			●			●			●			●												
	Auxiliary switch (AX)			●			●			●			●												
	Shunt trip (SHT)			●			●			●			●												
	Undervoltage trip (UVT)			●			●			●			●												
Accessory connections	With lead-wire terminal block (SLT)			●			●			●			●												
	With flying leads			●			●			●			●												
Built-in accessories	Pre-alarm contact output (PAL)			—			—			—			—												
	Enclosure	Dustproof	(S)			—			—			—													
(I)			—			—			—																
	Waterproof	(W)			—			—			—														
		(MD)			●			●			●														
Mechanical interlock (MI)			●			●			●			●													
Handle lock device	Handle lock	(HL)			●			●			●														
		(HL-S)			●			●			●														
		Lock cover (LC)			●			●			●														
External operating handle	Door mounting	(M)			—			—			—														
		(S)			●			●			●														
	(SS)			●			●			●															
	Mounted on breaker	(R)			—			—			—														
(F)			●			●			●																
Insulating barrier	Between phase (BA-F)			●			●			●															
	To ground (BA-G)			●			●			●															
Terminal cover	Large	(TC-L)			●			●			●														
		(TC-S)			●			●		—		●			—										
	Transparent (TTC)			●			●			●															
	For rear connection	(BTC)			●			●			●														
For plug-in (PTC)			—			—			—																
Adapter for IEC 35mm rail			—			—			—			—													
Marine approval (NK, etc.)			●			●			—			●			—										
Automatic tripping device			Thermal, magnetic			Thermal, magnetic			Thermal, magnetic			Thermal, magnetic													
Trip button			—			—			Equipped			—													

* 1. Rating at 40°C is also available. Please specify when ordering.
* 2. Specify if for DC use.

* 3. Bolt terminal.

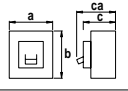
Frame (A)		400		630		800		
Type		NF400-UEP		NF630-UEP		NF800-UEP		
Photo								
Rated current I _n (A) at ambient temperature 40°C		200~400 adjustable		300~630 adjustable		400~800 adjustable		
Number of poles		3	4	3	4	3	4	
Rated insulation voltage U _i (V)		AC 690 DC —		AC 690 DC —		AC 690 DC —		
Rated breaking capacity (kA)	IEC60947-2 (Icu/Ics)	AC	690V	35/35	35/35	35/35	35/35	
			500V	170/170	170/170	170/170	170/170	
			440V	200/200	200/200	200/200	200/200	
			415V	200/200	200/200	200/200	200/200	
			400V	200/200	200/200	200/200	200/200	
			380V	200/200	200/200	200/200	200/200	
			230V	200/200	200/200	200/200	200/200	
			DC	250V	—	—	—	—
Utilization category		B		B		B		
Reverse connection		●		●		●		
Rated short-time withstand current I _{sw} (kA)		5		7.6		9.6		
Rated impulse withstand voltage U _{imp} (kV)		8		8		8		
Pollution degree		3		3		3		
Dimensions (mm)		a	140	280	210	280	210	280
		b	297	322	322	322	322	322
		c	200	200	200	200	200	200
		ca	252	252	252	252	252	252
Weight (kg)		16.7	26.1	25.7	31.9	27.6	33.7	
Installation and connection	Front (F)	Screw terminal	—	—	—	—	—	
		Solderless terminal	—	—	—	—	—	
		Bus bar terminal	●	●	●	●	●	
	Rear	(B)	●	●	●	●	●	
		(FP)	●	●	●	●	●	
	Flush	(PM)	●	—	●	—	●	—
		Rear (PM-A)	—	—	—	—	—	—
Rear front IP20 with auto-trip (PM-L)		—	—	—	—	—	—	
Rear front IP20 with "ON-lock" (DPM)		—	—	—	—	—	—	
Cassette-type accessories	Alarm switch (AL)	●	●	●	●	●	●	
	Auxiliary switch (AX)	●	●	●	●	●	●	
	Shunt trip (SHT)	●	●	●	●	●	●	
	Undervoltage trip (UVT)	●	●	●	●	●	●	
Accessory connections	With lead-wire terminal block (SLT)	●	●	●	●	●	●	
	With flying leads	●	●	●	●	●	●	
Built-in accessories	Pre-alarm contact output (PAL)	● *2	● *2	● *2	● *2	● *2	● *2	
	Trip Indicator (TI)	●	●	●	●	●	●	
External accessories	Enclosure	Dustproof (S)	—	—	—	—	—	
		(I)	—	—	—	—	—	
		Waterproof (W)	—	—	—	—	—	
	Electrical operation device	Motor-operated type (MD)	●	●	●	●	●	
		Spring-charge type (MDS)	●	●	●	●	●	
	Mechanical interlock	(MI)	●	●	●	●	●	
		(HL)	●	●	●	●	●	
	Handle lock device	Handle lock (HL-S)	●	●	●	●	●	
		Lock cover (LC)	—	—	—	—	—	
	External operating handle	(V)	—	—	—	—	—	
		Door mounting (S)	●	●	●	●	●	
		(SS)	●	●	●	●	●	
		Mounted on breaker (F)	—	—	—	—	—	
	Insulating barrier	Between phase (BA-F)	●	●	●	●	●	
		To ground (BA-G)	●	●	●	●	●	
	Terminal cover	Large (TC-L)	●	●	●	●	●	
		Small (TC-S)	—	—	—	—	—	
		Trans-parent (TTC)	—	—	—	—	—	
	Adapter for IEC35mm rail	For rear connection (BTC)	●	●	●	●	●	
For plug-in (PTC)		—	—	—	—	—		
Marine approval (NK, etc.)	—	●	—	●	—	●	—	
Automatic tripping device	—	Electronic	—	Electronic Equipped	—	Electronic	—	
Trip button	—	—	—	—	—	—	—	





*1. Specify if for DC use.

*2. Solid state relay output is standard. Please specify if other output is necessary. (Standard type is thus SLT equipped.)



SPECIFICATIONS

EARTH-LEAKAGE CIRCUIT BREAKERS

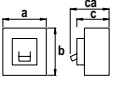
ELCBs NV-C Series (Economy type)

Frame (A)		30	50	60	100	225	
Type		NV30-CS	NV50-CP	NV60-CP	NV100-CP	NV225-CP	
Photo							
Supply system * 1		3ø3W, 1ø2W, 1ø3W	3ø3W, 1ø2W, 1ø3W	3ø3W, 1ø2W, 1ø3W	3ø3W, 1ø2W, 1ø3W	3ø3W, 1ø2W, 1ø3W	
Number of poles		3	3	3	3	3	
Rated operational voltage Ue AC V		230	230-400-440 Multi-voltage type	230-400-440 Multi-voltage type	230-400-440 Multi-voltage type	230-400-440 Multi-voltage type	
Rated current In (A) at ambient temperature 30°C		5,10,15, 20,30	15,20,30 40,50	60	60,75,100	125,150,175 200,225	
High-speed type	Rated current sensitivity I _{Δn} (mA)	30	30•100•500 Selectable	30•100•500 Selectable	30•100•500 Selectable	30•100•500 Selectable	
	Max. operating time at 5I _{Δn} (s)	0.04	0.04	0.04	0.04	0.04	
Time-delay type	Rated current sensitivity I _{Δn} (mA)	—	—	—	100•300•500 Selectable	100•300•500 Selectable	
	Max. operating time at 2I _{Δn} (s)	—	—	—	0.45•1.0•2.0 Selectable	0.45•1.0•2.0 Selectable	
	Inertial non-operating time at 2I _{Δn} (s)	—	—	—	0.1•0.5•1.0	0.1•0.5•1.0	
Earth-leakage indication system		Button	Button	Button	Button	Button	
Characteristics for DC components		Type AC		Type AC	Type AC	Type AC	
Rated breaking capacity (kA) IEC60947-2 Icu/Ics	AC	440V	—	2.5/1	2.5/1	10/5	15/8
		400V	—	5/2	5/2	10/5	18/9
		230V	2.5/2	5/2	5/2	25/13	30/15
Dimensions (mm)		a	67.5	75	75	90	105
		b	96	130	130	155	165
		c	52	68	68	68	68
		ca	67	90	90	90	92
Weight		kg	0.4	0.7	0.8	1.1	1.7
Connection	Front (F)	Screw terminal	●	●	●	●	● *2
		Solderless terminal	—	—	—	●	●
	Rear	(B)	●	●	●	●	●
	Plug-in	(PM)	—	●	●	●	●
Flush plate	(FP)	—	●	●	●	●	
Accessories	Alarm switch	(AL)	●	●	●	●	●
	Auxiliary switch	(AX)	●	●	●	●	●
	Insulation switch	(MG)	●	●	●	●	●
	Earth-leakage trip alarm	(EAL)	—	●	●	●	●
	Test button module	(TBM)	—	●	●	●	●
	Lead-wire terminal block	(SLT)	●	●	●	●	●
	Load-side flying lead type		●	●	●	●	●
External accessories	Enclosure	Dustproof	(S)	●	●	●	●
		Dustproof	(I)	—	●	●	●
		Water proof	(W)	—	●	●	●
	Electrical operation device	(MD)	—	—	—	●	●
	Mechanical interlock	(MI)	—	●	●	●	●
	Handle lock device	(HL)	—	●	●	●	●
		(HL-S)	—	●	●	●	●
		(LC)	●	●	●	●	●
	External operating handle	(F)	—	●	●	●	●
		(S)	—	●	●	●	●
	Terminal cover	(TC-L)	●	●	●	●	●
		(BTC)	●	●	●	●	●
Rear	(B-ST)	●	●	●	●	●	
Flush	(FP)	—	●	●	●	●	
Automatic tripping device		Hydraulic-magnetic	Hydraulic-magnetic	Hydraulic-magnetic	Thermal, magnetic	Thermal, magnetic	
Trip button		—	—	—	Equipped		

* 1. If using a 3-pole earth-leakage breaker as a 1-pole 2-phase device, connect the left and right poles and not the central pole. If using as 1-pole 3-phase, connect the neutral wire to the central pole.
* 2. Bolt terminal

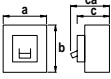



Frame (A)		400	630		
Type		NV400-CP	NV630-CP		
Photo					
Supply system *1		3ø3W, 1ø3W, 1ø2W	3ø3W, 1ø3W, 1ø2W		
Number of poles		3	3		
Rated operational voltage Ue		VAC Multi-voltage type 230- 400- 440	VAC Multi-voltage type 230- 400- 440		
Rated current In (A) at ambient temperature 40°C		250, 300, 350, 400	500, 600, 630		
High-speed type	Rated current sensitivity IΔn (mA)	30•100•500 Selectable	—		
	Max. operating time at 5IΔn (s)	0.04	—		
Time-delay type	Rated current sensitivity IΔn (mA)	100•300•500 Selectable	100•300•500 Selectable		
	Max. operating time at 2IΔn (s)	0.45•1.0•2.0 Selectable	0.45•1.0• 2.0 Selectable		
	Inertial non-operating time at 2IΔn (s)	0.1•0.5•1.0	0.1•0.5•1.0		
Earth-leakage indication system		Button	Button		
Characteristics for DC components		Type AC	Type AC		
Utilization category		A	A		
Rated short-time withstand current Icw (kA)		—	—		
Rated impulse withstand voltage Uimp (kV)		8	8		
Pollution degree		3	3		
Rated breaking capacity (kA)	IEC60947-2 (Icu/Ics)	AC	440V	25/13	36/18
			400V	36/18	36/18
			230V	50/25	50/25
			a	140	210
Dimensions (mm)			b	257	275
			c	103	103
			ca	134	155
			Weight	kg	6.1
Connection	Front (F)	Bus bar terminal	●	●	
		Solderless terminal	●	●	
	Rear	(B)	●	●	
		(PM)	●	●	
		Plug-in	Rear front IP20 with auto-trip (PM-A)	—	—
		Rear front IP20 with "ON-lock" (PM-L)	—	—	
Front (DPM)	—	—			
Flush plate (FP)	●	●			
Cassette-type accessories	Alarm switch (AL)	●	●		
	Auxiliary switch (AX)	●	●		
	Shunt trip (SHT)	●	●		
	Undervoltage trip (UVT)	●	●		
Built-in accessories	Insulation switch (MG)	●	●		
	Earth-leakage trip alarm (EAL)	●	●		
	Test button module (TBM)	●	●		
Accessories connection	With lead-wire terminal block (SLT)	●	●		
	With flying leads	●	●		
External accessories	Enclosure	Dustproof (S)	—	—	
		(I)	●	●	
		Waterproof (W)	●	●	
	Electrical operation device	Motor-operated type (MD)	●	●	
		Spring-charged type (MDS)	●	●	
	Mechanical interlock (MI)	●	●		
	Handle lock device	(HL)	●	●	
		(HL-S)	●	●	
		(LC)	—	—	
	External operating handle	(F)	●	●	
		(S)	●	●	
	Terminal cover	(TC-L)	●	●	
(BTC)		●	●		
Rear (B-ST)	●	●			
Flush (FP)	●	●			
Reverse connection	●	●			
Automatic tripping device	Thermal, magnetic	Thermal, magnetic			
Trip button	Equipped	Equipped			

* 1. If using a 3-pole earth-leakage breaker as a 1-pole 2-phase device, connect the left and right poles and not the central pole. If using as a 1-pole 3-phase, connect the neutral wire to the central pole.

SPECIFICATIONS





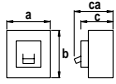



EARTH-LEAKAGE CIRCUIT BREAKERS

ELCBs NV-S Series (Standard type)

Frame (A)		30	50	60	100		
Type		NV30-SP	NV50-HP	NV60-HP	NV100-SP	NV100-SEP	
Photo							
Supply system *2		3ø3W, 1ø2W, 1ø3W	3ø3W, 1ø2W, 1ø3W	3ø3W, 1ø2W, 1ø3W	3ø3W, 1ø2W, 1ø3W	3ø3W, 1ø2W, 1ø3W 3ø4W	
Number of poles		3	3	3	3	3 4	
Rated operational voltage Ue V AC		230- 400- 440 Multi-voltage type	230- 400- 440 Multi-voltage type	230- 400- 440 Multi-voltage type	230- 400- 440 Multi-voltage type	230- 400- 440 Multi-voltage type	
Rated current In (A) at ambient temperature 30°C		5,10,15,20,30	15,20,30 40,50	60	15(*1),20,30,40 50,60,75,100	15-20,30-50,60-100 Adjustable	
High-speed type	Rated current sensitivity I _{Δn} (mA)	30•100•500 Selectable	30•100•500 Selectable	30•100•500 Selectable	30•100•500 Selectable	30•100•500 Selectable	
	Max. operating time at 5I _{Δn} (s)	0.04	0.04	0.04	0.04	0.04	
Time-delay type	Rated current sensitivity I _{Δn} (mA)	—	—	—	100•300•500 Selectable	100•300•500 Selectable	
	Max. operating time at 2I _{Δn} (s)	—	—	—	0.45•1.0•2.0 Selectable	0.45•1.0•2.0 Selectable	
	Inertial non-operating time at 2I _{Δn} (s)	—	—	—	0.1•0.5•1.0	0.1•0.5•1.0	
Earth-leakage indication system		Button	Button	Button	Button	Button	
Characteristics for DC components		Type AC	Type AC	Type AC	Type AC	Type AC	
Rated breaking capacity (kA) IEC60947-2 cu/lcs	AC	440V	5/2	10/5	10/5	25/13	25/13
		400V	5/2	10/5	10/5	30/15	30/15
		230V	10/5	25/13	25/13	50/25	50/25
Dimensions (mm)		a	75	75	75	90	90 120
		b	130	130	130	155	155
		c	68	68	68	68	68
		ca	90	90	90	90	90
Weight kg		0.8	0.8	0.8	1.2	1.2 1.5	
Connection	Front (F)	Screw terminal	●	●	●	●	●
		Solderless terminal	—	—	—	●	●
	Rear (B)	●	●	●	●	●	
	Plug-in (PM)	●	●	●	●	●	
Flush plate (FP)	●	●	●	●	●		
Internal accessories	Pre-alarm Contacts (PAL)	—	—	—	—	●	
	Alarm switch (AL)	●	●	●	●	●	
	Auxiliary switch (AX)	●	●	●	●	●	
	Insulation switch (MG)	●	●	●	●	●	
	Test lead switch (TBL)	●	●	●	●	●	
	Earth-leakage trip alarm (EAL)	●	●	●	●	●	
	Lead-wire terminal block (SLT)	●	●	●	●	●	
	Load side flying lead type	●	●	●	●	●	
External accessories	Enclosure	Dustproof (S)	●	●	●	●	● —
		Dustproof (I)	●	●	●	●	● —
		Waterproof (W)	●	●	●	●	● —
	Electrical operation device (MD)	—	—	—	●	●	
	Mechanical interlock (MI)	●	●	●	●	●	
	Handle lock device	(HL)	●	●	●	●	●
		(HL-S)	●	●	●	●	●
		(LC)	●	●	●	●	●
	External operating handle	(F)	●	●	●	●	●
		(S)	●	●	●	●	●
	Terminal cover	(TCL)	●	●	●	●	●
(BTC)		●	●	●	●	● —	
Rear (B-ST)	●	●	●	●	●		
Flush (FP)	●	●	●	●	●		
Automatic tripping device		Hydraulic-magnetic	Hydraulic-magnetic	Hydraulic-magnetic	Thermal, magnetic	Electronic	
Trip button		Equipped					

* 1. Time delay type is not available for ampere rating 15A.

* 2. If using a 3-pole earth-leakage breaker as a 1-pole 2-phase device, connect the left and right poles and not the central pole. If using as 1-pole 3-phase, connect the neutral wire to the central pole.

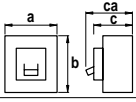
Frame (A)		100			225					
Type		NV100-HP	NV100-HEP	NV100-RP	NV225-SP	NV225-SEP	NV225-HP	NV225-HEP	NV225-RP	
Photo										
Supply system	*4	3ø3W, 1ø2W, 1ø3W	3ø3W, 1ø2W, 1ø3W	3ø3W, 1ø3W, 1ø2W	3ø3W, 1ø2W, 1ø3W	3ø3W, 1ø3W, 1ø2W	3ø3W, 1ø2W, 1ø3W	3ø3W, 1ø2W, 1ø3W	3ø3W, 1ø2W, 1ø3W	
Number of poles		3	3 4	3	3	3 4	3	3 4	3	
Rated operational voltage Ue	V AC	230- 400- 440 Multi-voltage type	230- 400- 440 Multi-voltage type	230- 400- 440 Multi-voltage type	230- 400- 440 Multi-voltage type	230- 400- 440 Multi-voltage type	230- 400- 440 Multi-voltage type	230- 400- 440 Multi-voltage type	230- 400- 440 Multi-voltage type	
Rated current In (A) at ambient temperature 30°C		15(*1), 20, 30 (40), 50, 60, 75, 100	15-20, 30-50, 60-100 Adjustable	15(*1), 20, 30 (40), 50, 60, 75, 100	125, 150, 175, 200, 225	125-225 Adjustable	125, 150, 175, 200, 225	125-225 Adjustable	125, 150, 175, 200, 225	
High-speed type	Rated current sensitivity IΔn (mA)	30•100•500 Selectable	30•100•500 Selectable	30•100•500 Selectable	30•100•500 Selectable	30•100•500 Selectable	30•100•500 Selectable	30•100•500 Selectable	30•100•500 Selectable	
	Max. operating time at 5 IΔn (s)	0.04	0.04	0.04	0.04	0.04	0.04	0.04	0.04	
Time-delay type	Rated current sensitivity IΔn (mA)	100•300•500 Selectable	100•300•500 Selectable	100•300•500 Selectable	100•300•500 Selectable	100•300•500 Selectable	100•300•500 Selectable	100•300•500 Selectable	100•300•500 Selectable	
	Max. operating time at 2 IΔn (s)	0.45•1.0•2.0 Selectable	0.45•1.0•2.0 Selectable	0.45•1.0•2.0 Selectable	0.45•1.0•2.0 Selectable	0.45•1.0•2.0 Selectable	0.45•1.0•2.0 Selectable	0.45•1.0•2.0 Selectable	0.45•1.0•2.0 Selectable	
	Inertial non-operating time at 2 IΔn (s)	0.1•0.5•1.0	0.1•0.5•1.0	0.1•0.5•1.0	0.1•0.5•1.0	0.1•0.5•1.0	0.1•0.5•1.0	0.1•0.5•1.0	0.1•0.5•1.0	
Earth-leakage indication system		Button	Button	Button	Button	Button	Button	Button	Button	
Characteristics for DC components		Type AC	Type AC	Type AC	Type AC	Type AC	Type AC	Type AC	Type AC	
Rated breaking capacity (kA) IEC60947-2 (Icu/Ics)	AC	440V	50/25	50/25	125/125	25/13	25/13	50/13	50/13	125/125
		400V	50/25	50/25	125/125	30/15	30/15	50/13	50/13	125/125
		230V	100/50	100/50	125/125	50/25	50/25	100/25	100/25	125/125
Dimensions (mm)		a	90	90 120	90	105	105 140	105	105 140	105
		b	155	155	216	165	165	165	165	240
		c	68	68	68	68	68	68	68	68
		ca	90	90	90	92	92	92	92	92
		Weight	kg	1.2	1.2 1.5	1.9	1.7	1.8 2.3	1.7	1.8 2.3
Connection	Front (F)	Screw terminal	●	●	●	● *2	● *2	● *2	● *2	● *2
		Solderless terminal	●	●	●	●	● *3	●	● *3	●
	Rear	●	●	●	●	●	●	●	●	
	Plug-in (PM)	●	●	●	●	●	●	●	●	
Flush (FP)	●	●	●	●	●	●	●	●	●	
Internal accessories	Pre-alarm Contact (PAL)	—	●	—	—	—	—	—	—	
	Alarm switch (AL)	●	●	●	●	●	●	●	●	
	Auxiliary switch (AX)	●	●	●	●	●	●	●	●	
	Insulation switch (MG)	●	●	●	●	●	●	●	●	
	Earth-leakage trip alarm (EAL)	●	●	●	●	●	●	●	●	
	Test button module (TBM)	●	●	●	●	●	●	●	●	
	Lead-wire terminal block (SLT)	●	●	●	●	●	●	●	●	
Load side flying lead type	●	●	●	●	●	●	●	●		
External accessories	Enclosure	Dustproof (S)	●	● —	—	●	● —	●	● —	—
		Dustproof (I)	●	● —	—	●	● —	●	● —	—
		Water proof (W)	●	● —	—	●	● —	●	● —	—
	Electrical operation device (MD)	●	●	●	●	●	●	●	●	
	Mechanical interlock (MI)	●	●	●	●	●	●	●	●	
	Handle lock device	(HL)	●	●	●	●	●	●	●	●
		(HL-S)	●	●	●	●	●	●	●	●
		(LC)	●	●	●	●	●	●	●	●
	External Operating handle	(F)	●	●	●	●	●	●	●	●
		(S)	●	●	●	●	●	●	●	●
	Terminal cover	(TCL)	●	●	●	●	●	●	●	●
(BTC)		●	● —	—	●	● —	●	● —	●	
Rear (B-ST)	●	●	●	●	●	●	●	●		
Flush (FP)	●	●	●	●	●	●	●	●		
Automatic tripping device		Thermal, magnetic	Electronic	Thermal, magnetic	Thermal, magnetic	Electronic	Thermal, magnetic	Electronic	Thermal, magnetic	
Trip button		Equipped								

* 1. Time delay type is not available for ampere rating 15A.

* 2. Bolt terminal





* 3. With solderless terminal, the rated current is 125-200A at 40°C.

* 4. If using a 3-pole earth-leakage breaker as a 1-pole 2-phase device, connect the left and right poles and not the central pole. If using as a 1-pole 3-phase, connect the neutral wire to the central pole.



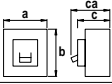

SPECIFICATIONS

EARTH LEAKAGE CIRCUIT BREAKERS

ELCBs NV-S Series (Standard type)

Frame (A)		400					
Type		NV400-SP	NV400-SEP	NV400-HEP	NV400-REP		
Photo							
Supply system		3ø3W, 1ø3W, 1ø2W	3ø3W, 1ø3W, 1ø2W	3ø3W, 1ø3W, 1ø2W	3ø3W, 1ø3W, 1ø2W		
Number of poles		3	3 4	3 4	3		
Rated operational voltage Ue		230-400-440 VAC					
Rated current In (A) at ambient temperature 40°C		Multi-voltage type 250,300,350,400					
High-speed type	Rated current sensitivity IΔn (mA)	30•100•500 Selectable					
	Max. operating time at 5 IΔn (s)	0.04					
Time-delay type	Rated current sensitivity IΔn (mA)	100•300•500 Selectable					
	Max. operating time at 2 IΔn (s)	0.45•1.0•2.0 Selectable					
	Inertial non-operating time at 2 IΔn (s)	0.1•0.5•1.0					
Earth-leakage indication system		Button					
Characteristics for DC components		Type AC					
Utilization category		A B B B					
Rated short-time withstand current Icw (kA)		— 5 5 5					
Rated impulse withstand voltage Uimp (kV)		8 8 8 8					
Pollution degree		3 3 3 3					
Rated breaking capacity (kA)	IEC60947-2 (Icu/Ics)	AC	440V	42/42 (36/36) *1	42/42 (36/36) *1	65/65	125/63
			400V	45/45 (36/36) *1	45/45 (36/36) *1	70/70	125/63
			230V	85/85 (65/65) *1	85/85 (65/65) *1	100/100	150/75
Dimensions (mm)			a	140	140 185	140 185	140
			b	257	257	257	257
			c	103	103	103	103
			ca	155	155	155	155
Weight		kg	6.1	6.6 8.4	6.6 8.4	6.6	
Connection	Front (F)	Bus bar terminal	●	●	●	●	
		Solderless terminal	●	●	—	—	
	Rear	(B)	●	●	●	●	
		(PM)	●	●	●	●	
		Rear front IP20 with auto-trip (PM-A)	—	—	—	—	
		Rear front IP20 with "ON-lock" (PM-L)	—	—	—	—	
Plug-in	Front (DPM)	—	—	—	—		
Flush plate (FP)	●	●	●	●			
Cassette-type accessories	Alarm switch (AL)	●	●	●	●		
	Auxiliary switch (AX)	●	●	●	●		
	Shunt trip (SHT)	●	●	●	●		
	Undervoltage trip (UVT)	●	●	●	●		
Built-in accessories	Insulation switch (MG)	●	●	●	●		
	Earth-leakage trip alarm (EAL)	●	●	●	●		
	Test button module (TBM)	●	●	●	●		
Accessory connections	With lead-wire terminal block (SLT)	●	●	●	●		
	With frying leads	●	●	●	●		
External accessories	Enclosure	Dustproof (S)	—	—	—	—	
		(I)	●	● —	—	—	
		Waterproof (W)	●	● —	—	—	
	Electrical operation device	Motor-operated type (MD)	●	●	●	●	
		Spring-charge type (MDS)	●	●	●	●	
	Mechanical interlock (MI)	●	●	●	●		
	Handle lock device	(HL)	●	●	●	●	
		(HL-S)	●	●	●	●	
		(LC)	—	—	—	—	
	External operating handle	(F)	●	●	●	●	
(S)		●	●	●	●		
Terminal cover	(TC-L)	●	●	—	—		
	(BTC)	●	●	— ●	—		
Reverse connection		●	●	●	●		
Automatic tripping device		Thermal, magnetic		Electronic		Electronic	
Trip button		Equipped					



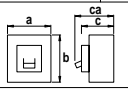





*1. In case of solderless terminal, interrupting capacity reduces as follows.

Frame (A)		630			800			
Type		NV630-SP	NV630-SEP	NV630-HEP	NV800-SEP	NV800-HEP		
Photo								
Supply system		3ø3W, 1ø3W, 1ø2W	3ø3W, 1ø3W, 1ø2W 3ø4W	3ø3W, 1ø3W, 1ø2W	3ø3W, 1ø3W, 1ø2W	3ø3W, 1ø3W, 1ø2W		
Number of poles		3	3 4	3	3	3		
Rated operational voltage Ue VAC		230-400-440 Multi-voltage type	230-400-440 Multi-voltage type	230-400-440 Multi-voltage type	230-400-440 Multi-voltage type	230-400-440 Multi-voltage type		
Rated current In (A) at ambient temperature 40°C		500,600,630	300-630 Adjustable	300-630 Adjustable	400-800 Adjustable	400-800 Adjustable		
High-speed type	Rated current sensitivity I _{Δn} (mA)	—	—	—	—	—		
	Max. operating time at 5 I _{Δn} (s)	—	—	—	—	—		
Time-delay type	Rated current sensitivity I _{Δn} (mA)	100•300•500 Selectable	100•300•500 Selectable	100•300•500 Selectable	100•300•500 Selectable	100•300•500 Selectable		
	Max. operating time at 2 I _{Δn} (s)	0.45•1.0•2.0 Selectable	0.45•1.0•2.0 Selectable	0.45•1.0•2.0 Selectable	0.45•1.0•2.0 Selectable	0.45•1.0•2.0 Selectable		
	Inertial non-operating time at 2 I _{Δn} (s)	0.1•0.5•1.0	0.1•0.5•1.0	0.1•0.5•1.0	0.1•0.5•1.0	0.1•0.5•1.0		
Earth-leakage indication system		Button	Button	Button	Button	Button		
Characteristics for DC components		Type AC	Type AC	Type AC	Type AC	Type AC		
Utilization category		A	B	B	B	B		
Rated short-time withstand current I _{sw} (kA)		—	7.6	7.6	9.6	9.6		
Rated impulse withstand voltage U _{imp} (kV)		8	8	8	8	8		
Pollution degree		3	3	3	3	3		
Rated breaking capacity (kA)	IEC60947-2 (Icu/Ics)	AC	440V	42/42	42/42	65/65	42/42	65/65
			400V	45/45	45/45	70/70	45/45	70/70
			230V	85/85	85/85	100/100	85/85	100/100
Dimensions (mm)		a	210	210 280	210	210	210	
		b	275	275	275	275	275	
		c	103	103	103	103	103	
		ca	155	155	155	155	155	
		Weight	kg	12.5	14.3 18.6	14.3	15.3	15.3
Connection	Front (F)	Bus bar terminal	●	●	●	●	●	
		Solderless terminal	●	●	—	●	—	
	Rear (B)	Plug-in	Rear (PM)	●	●	●	●	●
		Rear front IP20 with auto-trip (PM-A)	—	—	—	—	—	
		Rear front IP20 with "ON-lock" (PM-L)	—	—	—	—	—	
		Front (DPM)	—	—	—	—	—	
Flush plate (FP)		●	●	●	●	●		
Cassette-type accessories	Alarm switch (AL)	●	●	●	●	●		
	Auxiliary switch (AX)	●	●	●	●	●		
	Shunt trip (SHT)	●	●	●	●	●		
	Undervoltage trip (UVT)	●	●	●	●	●		
Built-in accessories	Insulation switch (MG)	●	●	●	●	●		
	Earth-leakage trip alarm (EAL)	●	●	●	●	●		
	Test button module (TBM)	●	●	●	●	●		
Accessory connection	With lead-wire terminal block (SLT)	●	●	●	●	●		
	With flying leads	●	●	●	●	●		
External accessories	Enclosure	Dustproof (S)	—	—	—	—	—	
		Waterproof (I)	●	● —	—	●	—	
		Waterproof (W)	●	● —	—	●	—	
	Electric operation device	Motor-operated type (MD)	●	●	●	●	●	
		Spring-charge type (MDS)	●	●	●	●	●	
	Mechanical interlock	(MI)	●	●	●	●	●	
		(HL)	●	●	●	●	●	
		(HL-S)	●	●	●	●	●	
	Handle lock device	(LC)	—	—	—	—	—	
		(F)	●	●	●	●	●	
	External operating handle	(S)	●	●	●	●	●	
(TC-L)		●	●	—	●	—		
Terminal cover	(BTO)	●	●	●	●	●		
	(S)	●	●	●	●	●		
Reverse connection		●	●	●	●	●		
Automatic tripping device		Thermal, magnetic	Electronic	Electronic	Electronic	Electronic		
Trip button				Equipped				





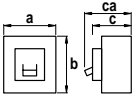



SPECIFICATIONS

MINIATURE CIRCUIT BREAKERS

BH Series

Type		BH			BH-P			
Frame (A)		70	100	100	70	100	100	
Photo								
Number of poles		1	2	3	1	2	3	
Rated current (A) at ambient temperature 40° C		70	70,100	70,100	70	70,100	70,100	
Rated insulation voltage (V)		AC	230/400			230/400		
		DC	125			125		
Breaking capacity (kA) sym.		IEC60898 AC230/400V	3			3		
		— DC125V	1			1		
Type of instantaneous operation		Type C (5 In <, <10 In)						
Dimensions (mm) 		a	25	50	75	25	50	75
		b	95			74		
		c	57.5			60.5		
		ca	77.5			79		
Weight (kg)		0.16	0.32	0.48	0.13	0.26	0.38	
Connection		Clamp terminal			Plug-in (line) Clamp (load)			
								
Automatic tripping device		Thermal, magnetic						
Optional accessories *		Terminal cover	●			—		
		Mounting plate	●			—		
		Terminal base	—			●		
		Lock cover	●			●		
Approved by		—	LR, GL, NK	—	—	LR, BV, AB, GL, NK	—	

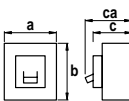
* Specify if required - cost is additional.









Type		BH-S M3			BH-S M6			
Photo								
Number of poles		1	2	3	1	2	3	
Rated current (A) at ambient temperature 40°C		5,10,15,20,(25), 30,40,50,60	10,15,20,(25), 30,40,50,60	15,20,(25), 30,40,50,60	5,10,15,20,(25), 30,40,50,60	10,15,20,(25), 30,40,50,60	15,20,(25), 30,40,50,60	
Rated insulation voltage (V)		AC	230/400	400	400	230/400	400	
		DC	—	125	—	—	125	—
Breaking capacity (kA) sym.		IEC60898 AC230/400V	3			6		
		— DC125V	—	1	—	—	1	—
Type of instantaneous operation		Types B,C,D *						
Dimensions (mm) 		a	25	50	75	25	50	75
		b	95			95		
		c	57.5			57.5		
		ca	76			76		
Weight (kg)		0.15	0.32	0.50	0.15	0.32	0.50	
Connection		Clamp terminal						
								
Automatic tripping device		Thermal, magnetic						
Optional accessories		Terminal cover	●					
		Mounting plate	●					
		Handle lock	●					
		Lock cover	—					
Approved by		—						

* Type B (3 In <, ≤ 5 In), Type C (5 In <, ≤ 10 In), Type D (10 In <, ≤ 20 In)





SPECIFICATIONS



MINIATURE CIRCUIT BREAKERS



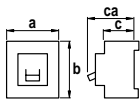

BH Series

Type		BH-PS M3			BH-PS M9		
Photo							
Number of poles		1	2	3	1	2	3
Rated current (A) at ambient temperature 40°C		10,15,20,30,40,50,60	10,15,20,30,40,50,60	15,20,30,40,50,60	6,10,16,20,(25),32,40,50,60	10,16,20,(25),32,40,50,60	10,16,20,(25),32,40,50,60
Rated insulation voltage (V)	AC	230/400	400	400	230/400	400	400
	DC	—	125	—	—	—	—
Breaking capacity (kA) sym.	IEC60898 AC230/400V	3			9		
	— DC125V	—	1	—	—		
Type of instantaneous operation		Types B,C,D *					
Dimensions (mm)	a	25	50	75	25	50	75
	b	81.5			81.5		
	c	60.5			60.5		
	ca	79			79		
Weight (kg)		0.15	0.32	0.50	0.15	0.32	0.50
Connection		Plug-in (line)			Clamp (load)		
							
Automatic tripping device		Thermal, magnetic					
Optional accessories	Terminal cover	—					
	Terminal base	●					
	Lock cover	—					
	Handle lock	●					
Approved by		—			LR		

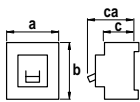
* Type B (3 In <, ≤ 5 In), Type C (5 In <, ≤ 10 In), Type D (10 In <, ≤ 20 In)

MCB	BH-D6 (IEC60898)				
Photo					
Number of poles	1	2	3	4	
Rated current (A) at ambient temperature 30°C	6, 10, 13, 16, 20, 25, 32, 40, 50, 63	6, 10, 13, 16, 20, 25, 32, 40, 50, 63	6, 10, 13, 16, 20, 25, 32, 40, 50, 63	6, 10, 13, 16, 20, 25, 32, 40, 50, 63	
Rated voltage (VAC)	230/400	400	400	400	
Breaking capacity (IEC60898)	6kA				
Tripping characteristics	Type B, C				
Dimensions (mm) 	a	18	36	54	72
	b	87			
	c	44			
	ca	70			
Weight (kg)	0.15	0.30	0.45	0.6	
Connection	Solderless				
Automatic tripping device	Thermal, magnetic				
Optional accessories	Insulating barrier	—	1 pc	2 pcs	3 pcs

RCCB	BV-D (IEC61008)		
Photo			
Number of poles	2	4	
Rated current (A) at ambient temperature 30°C	25, 40, 63		
Rated voltage (VAC)	230	230/400	
Rated current sensitivity I Δ n (mA)	30, 300		
Max. operating time (sec) at 5I Δ	0.04		
Pulsating current sensitivity	Type AC		
Rated conditional short-circuit current (kA)	6		
Dimensions (mm) 	a	36	72
	b	85	
	c	44	
	ca	70	
Weight (kg)	0.2	0.35	
Connection	Solderless		

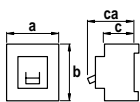
Isolating switch	KB-D (IEC60947-3)				
Photo					
Number of poles	1	2	3	4	
Utilization category	AC22A class				
Rated current (A) at ambient temperature 30°C	32, 63				
Rated voltage (VAC)	230	400			
Short time withstand current (A)	20 X I _n , 1sec				
Short-circuit making capacity (A)	20 X I _n				
Dimensions (mm) 	a	18	36	54	72
	b	87			
	c	44			
	ca	70			
Weight (kg)	0.09	0.18	0.27	0.36	
Connection	Solderless				
Optional accessories	Insulating barrier	—	1 pc	2 pcs	3 pcs

SPECIFICATIONS

MOTOR PROTECTION

MCCB MB Series

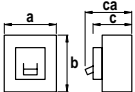
Frame (A)		30	50	100	225			
Type		MB30-SP	MB50-CP	MB50-SP	MB100-SP	MB225-SP		
Rated current (In), A		0.8, 1.2, 1.4, 2, 2.5, 4, 5, 7.1, 8, 10, 12, 16, 25, 32	0.8, 1.2, 1.4, 2, 2.5, 4, 5, 7.1, 8, 10, 12, 16, 25, 32, 40, 45	0.8, 1.2, 1.4, 2, 2.5, 4, 5, 7.1, 8, 10, 12, 16, 25, 32, 40, 45	12.5, 16, 25, 32, 40, 45, 63, 71, 90, 100	125, 150, 175, 200, 225		
Rated ambient temperature, °C *1		30	30	30	30	30		
Number of poles		3	3	3	3	3		
Rated insulation voltage Ui (V)		500	500	500	500	500		
Rated short-circuit breaking capacity, r.m.s. (kA) as per IEC60947-2 (Icu/Ics)	Ue	500V AC	—	—	—	—		
		440V AC	2.5/1	2.5/1	7.5/4	25/13	25/13	
		400V AC	5/2	5/2	7.5/4	30/15	30/15	
		230V AC	5/2	5/2	10/5	50/25	50/25	
Utilization category		A	A	A	A	A		
Reverse connection		●	●	●	●	●		
Rated impulse withstand voltage Uimp (kV)		6	6	6	6	6		
Pollution degree		2	2	2	2	2		
Dimensions (mm)		a	75	75	75	90	105	
		b	130	130	130	155	165	
		c	68	68	68	68	68	
		ca	90	90	90	90	92	
Weight		Kg	0.65	0.65	0.75	1.1	1.5	
Installation and connection	Fixed	Front (F)	Screw terminal	●	●	●	●	● *2
			Solderless terminal	—	—	—	●	●
			Bus bar terminal	●	●	●	●	●
	Flush	Rear (B)	●	●	●	●	●	
			(FP)	●	●	●	●	●
	Plug-in	Rear (PM)	●	●	●	●	●	
Rear with auto-trip (PM-A)		—	—	—	—	●		
Front (DPM)		●	●	●	●	●		
Cassette-type accessories	Alarm switch (AL)	●	●	●	●	●		
	Auxiliary switch (AX)	●	●	●	●	●		
	Shunt trip (SHT)	●	●	●	●	●		
	Undervoltage trip (UVT)	●	●	●	●	●		
Accessory connections	With lead-wire terminal block (SLT)	●	●	●	●	●		
	With flying lead	●	●	●	●	●		
Built-in accessories	Pre-alarm contact output (PAL)	—	—	—	—	—		
	Enclosure	Dustproof (S)	●	●	●	●		
		(I)	●	●	●	●		
		Waterproof (W)	●	●	●	●		
	Electrical operation device (MD)	—	—	—	●	●		
	Mechanical interlock (MI)	●	●	●	●	●		
Handle lock device	Handle lock	(HL)	●	●	●	●		
		(HL-S)	●	●	●	●		
		(LC)	●	●	●	●		
External Operating handle	Door mounting	(V)	—	—	—	●		
		(S)	●	●	●	●		
		(SS)	●	●	●	—		
	Mounted on breaker	(R)	—	—	—	●	●	
(F)		●	●	●	●	●		
Insulating barrier	Between phase (BA-F)	●	●	●	●	●		
	To ground (BA-G)	●	●	●	●	●		
Terminal cover	Large (TC-L)	●	●	●	●	●		
	Small (TC-S)	●	●	●	●	●		
	Transparent (TTC)	●	●	●	●	●		
	For rear connection (BTC)	●	●	●	●	●		
	For plug-in (PTC)	●	●	●	●	●		
Adapter for IEC 35mm rail		●	●	●	●	—		
Marine approval (NK, etc.)		●	●	●	●	●		
Automatic tripping device		Hydraulic-magnetic	Hydraulic-magnetic	Hydraulic-magnetic	Thermal, magnetic	Thermal, magnetic		
Trip button		Equipped						

*1. Rating at 40°C is also available. Please specify when ordering.

*2. Bolt terminal.

ELCB MN Series

Fault protection		Earth-leakage, overload, short circuit and overheating of motor windings																	
Frame (A)		30			50					100		225							
Type		MN30-CS			MN50-CP		MN50-SP			MN100-SP		MN225-SP							
Phase and wires		* 1 3 ø3 w ; 1 ø2 w			3 ø3 w														
Number of poles		3			3		3			3		3							
Rated voltage (VAC)		100-200			120-240-415														
Ampere rating (A) at ambient temperature 40° C For class E motors of the corresponding outputs (kW)		A		kW		A		kW		A		kW		A		kW			
				100V	200V	200V/415V		200V/415V		200V/415V		200V/415V		200V/415V		200V/415V			
		32	—	7.5	45	11	22	8	—	3.7	45	11	22	7.1	1.5	—	100	—	55
		25	—	5.5	40	—	18.5	7.1	1.5	—	40	—	18.5	5	—	2.2	90	22	45
		16	0.75	3.7	32	7.5	15	5	—	2.2	32	7.5	15	4	0.75	1.5	71	18.5	37
		10	0.4	2.2	25	5.5	11	4	0.75	1.5	25	5.5	11	2.5	0.4	—	63	15	30
		7.1	—	1.5	16	3.7	7.5	2.5	0.4	—	16	3.7	7.5	2	—	0.75	45	11	22
		6.3	0.2	—	12	—	5.5	2	—	0.75	12	—	5.5	1.4	0.2	—	—	—	—
		4	0.1	0.75	10	2.2	—	1.4	0.2	—	10	2.2	—	1.2	—	0.4	—	—	—
		2.5	—	0.4	—	—	—	—	—	—	8	—	3.7	0.8	—	—	—	—	—
1.4	—	0.2	—	—	—	—	—	—	—	—	—	—	—	—	—	—	—		
High-speed type	Rated current sensitivity (mA)	15, 30, 100			30, 100 • 200 • 500 (Selectable)														
	Max. operating time (s)	0.1																	
Earth-leakage indication system		Button																	
Interrupting capacity (kA) JIS C8371	415V	—			2.5		7.5			25		25							
	240V	2.5 (200V)			5		10			50		50							
	120V	2.5 (100V)			5		10			50		50							
Dimensions (mm)	a	67.5			75		75			90		105							
	b	96			130		130			155		165							
	c	52			68		68			68		68							
	ca	67			90		90			90		92							
	Weight (kg)	0.4			0.7		0.7			1.2		1.7							
Connection		Clamp terminal					Screw terminal												
Accessories	Alarm switch (AL)	●		●		●			●		●								
	Auxiliary switch (AX)	●		●		●			●		●								
	Insulation switch (MG)	●		●		●			●		●								
	Test button lead wires (TBL)	●		●		●			●		●								
	Earth-leakage alarm (EAL)	—		●		●			●		●								
	Test-button module (TBM)	—		●		●			●		●								
	Lead-wire terminal block	LT	—		—		—			—		—							
		SLT	●		●		●			●		●							
	Electrical operation device (MD)	—		—		—			●		●								
	Mechanical interlock (MI)	—		●		●			●		●								
	Enclosure	Dustproof (S)	●		●		●			●		●							
		(I)	—		●		●			●		●							
		Waterproof (W)	—		●		●			●		●							
	Handle lock device (HL)	—		●		●			●		●								
	Lock cover (LC)	●		●		●			●		●								
	External handle	F	—		●		●			●		●							
		S	—		●		●			●		●							
Terminal cover (TCL)	●		●		●			●		●									
Rear stud	●		●		●			●		●									
Flush-mounting frame	—		●		●			●		●									
Plug-in terminal	—		●		●			●		●									
Conformation to IEC (Option)		—		—		—			—		—								
Automatic tripping device		Hydraulic-magnetic					Thermal, magnetic												







* 1. If using a 3-pole earth-leakage breaker as a 1-pole 2-phase device, connect the left and right poles and not the central pole.

SPECIFICATIONS

OTHERS

ELRs and ZCTs

Types ELR and ZCT are designed according to JIS C 8374.

Type		Type interchangeable ELR						For protective coordination			
		Electrical self-holding type			Mechanical self-holding type			Upstream interlock relay			
		NV-ZB			NV-ZS			NV-ZU			
Photo											
											
Type	ZCT aperture diameter (mm)	15	ZT15A		ZT15A		NV-Z15U				
		30	ZT30A		ZT30A		NV-Z30U				
		40	ZT40A		ZT40A		NV-Z40U				
		60		ZT60A		ZT60A		NV-Z60U			
		80		ZT80A		ZT80A		NV-Z80U			
		100		ZT100A		ZT100A		NV-Z100U			
Number of poles / phases		3ph 4w; 3ph 3w; 1ph 3w; 1ph 2w									
Rated voltage (VAC)		120 • 240 *			120 • 240, 240 • 415*			120 • 240, 240 • 415 *			
High speed type	Rated current sensitivity (mA)	30 100 • 500 * 200 • 500 *	100 • 500 * 200 • 500 *		30 200 • 500 *	200 • 500 *	30 200 • 500 • 1000 *	200 • 500 • 1000 *			
	Max. operating time (s)	0.1						0.1 (Backup time by interlock signal is 0.3sec.)			
Time delay type	Rated current sensitivity (mA)	200 • 500*			200 • 500 * 500 • 1000 *	200 • 500 * 500 • 1000 *	—				
	Operating time (s)	0.3			0.3 • 0.8 *			—			
	Inertial non-operating time (s)	0.1			0.1 • 0.5			—			
Earth-leakage indication		LED			Button			LED			
Resetting method		Push button or control power switch off			Push button (combined with earth-leakage indicator)			Push button or control power switch off			
Rated overcurrent (kA)		100 (peak value)									
Contacts	Number and type	1c			High speed: 2a (1a1b) Time delay: 1a1c			1a			
	Continuous current capacity (A)	5			7			5			
	Contact capacity (A)	Voltage	cosφ= 1	cosφ= 0.4 L/R=0.007	Voltage	cosφ= 1	cosφ= 0.4 L/R=0.007	Voltage	cosφ= 1	cosφ= 0.4 L/R=0.007	
		120VAC	5	2.5	120VAC	7	7	120VAC	5	2.5	
		240VAC	5	2	240VAC	7	7	240VAC	5	2	
		415VAC	5	2	415VAC	5	2	415VAC	1	0.6	
30VDC		5	2	30VDC	7	6	30VDC	5	2		
				100VDC	0.6	0.6					
				200VDC	0.3	0.3					
Connection		Clamp terminal									

* Selectable.

● Interchangeable ZCT

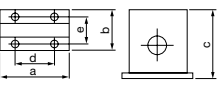
Type	ZT15A	ZT30A	ZT40A	ZT60A	ZT80A	ZT100A
Aperture diameter (mm)	15	30	40	60	80	100
Weight (kg)	0.2	0.4	0.6	2.0	2.6	3.3
Withstand current (kA)	100 (peak value)					
Dimensions (mm) 	a	48	68	85	140	185
	b	52	52	52	90	90
	c	70	90	100	150	169
	d	25	50	50	100	100
	e	40	40	40	70	70

● ZCT aperture diameter and permissible wire size

	ZCT aperture diameter (mm)	15	30	40	60	80	100
		Max. permissible 600V rated wire size in mm ² (current in amperes)					
1φ2w	Polyvinyl chloride insulated wire	14 (88)	60 (217)	150 (395)	325 (650)	600 (992)	800 (1185)
	Cross-linked polyethylene insulated cable	2 (33)	38 (190)	60 (260)	250 (655)	400 (870)	600 (1140)
1φ3w 3φ3w	Polyvinyl-chloride insulated wire	8 (61)	38 (162)	100 (298)	250 (556)	500 (842)	725 (1095)
	Cross-linked polyethylene insulated cable	2 (33)	22 (135)	60 (260)	200 (560)	325 (760)	600 (1140)
3φ4w	Polyvinyl-chloride insulated wire	8 (61)	38 (162)	100 (298)	150 (395)	325 (650)	600 (992)
	Cross-linked polyethylene insulated cable	—	14 (105)	38 (190)	100 (365)	250 (655)	400 (870)

● Interchangeable ZCTs with primary conductors

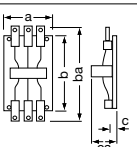
Type	ZTA600A	ZTA1200A	ZTA2000A	
Number of poles	3			
Rated voltage (VAC)	600			
Rated overcurrent (kA)	100 (peak value)			
	a	227	227	360
	b	256	298	250
	ba	366	444	594
	c	42	78	79
	ca	125	176	214

● ELRs with a ZCT with primary conductors

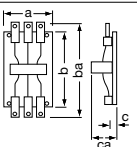
Frame (A)	600		1200	2000	3200
Type	ZB	Interchangeable ELR and interchangeable ZCTs with primary conductors			NV-ZB3200
	ZS				NV-ZS3200
	ZU	NV-ZU600	NV-ZU1200	NV-ZU2000	NV-ZU3200
Number of poles	3				
Rated voltage (VAC)	600				
Withstand current (kA)	100 (peak value)				
	a	227	227	360	490
	b	256	298	250	320
	ba	366	444	594	868
	c	42	78	79	111
	ca	125	176	214	290
Weight (kg)	6.5	11	27	54	



Specification of ELRs	High-speed type	Control voltage (VAC)		Rated current sensitivity (mA)	Max. operating time (s)	Inertial non-operating time (s)		
		ZB	120 • 240*				200 • 500*	0.1
		ZS	120 • 240, 240 • 415*		200 • 500*			
		ZU	120 • 240, 240 • 415*		200 • 500 • 1000*	0.1 (backup time by interlock signal is 0.3s)	—	
		Time-delay type	ZB	120 • 240*				200 • 500*
ZS	120 • 240, 240 • 415*		200 • 500*	0.3 • 0.8*	0.1 • 0.5*			

* Selectable.

SPECIFICATIONS

OTHERS

CIRCUIT PROTECTORS TYPE CP

Frame (A)		30									
Type		CP30-BA			CP-B			CP-S			
Photo											
Number of poles		1	2	3	1	2	3	1	2	3	
Rated voltage (V)		AC 250 DC 65	AC 250 DC 65	AC 250	AC 250 DC 65, DC125 (for 2-pole breakers series type only) *1						
Rated current (A)		0.1, 0.25, 0.3, 0.5, 1, 2, 3, 5, 7, 10, 15, 20, 30						0.05, 0.1, 0.25, 0.3, 0.5, 0.75, 1, 2, 2.5, 3, 5, 7, 7.5, 10, 15, 20, 25, 30			
Interrupting capacity (A)	AC	125V	—			2500			2500		
		240V	2500			—			—		
		250V	—			1500			1500		
	DC	60V	2500	—	—	1000 (DC65V)			1000 (DC65V)		
120V		—	2500	—	—	1000	—	—	1000	—	
Operating characteristics		Instantaneous type (I) Medium-speed type (M)			Instantaneous type (I) Fast type (F) Medium-speed type (M) Slow type (S)						
Tripping system		Instantaneous type (I): electronic type only Other types (M, F, S): hydraulic magnetic									
Standard ambient temperature (° C)		40			40			25			
Weight g		80	160	230	100	200	300	60	120	180	
Accessories	Inertial delay (ID)	● (Medium-speed: AC only)			● (Medium-speed, fast, slow: AC only)						
	Alarm switch (AL)	● (Ic)			● (Ia or Ib) (* 2)			● (Ic)			
	Auxiliary switch (AX)	● (Ic)			● (Ia or Ib)			● (Ic)			
	Shunt trip (SHT)	—			● (for relay type only)			● (for parallel and relay type)			
	Lock cover (LC)	—			●	—		●	—		
	Terminal cover	●			—			—			
Connection	Main body	20A or less : clamp terminal M4 30A : clamp terminal M5			Clamp terminal M5			Faston terminal #250			
	Alarm switch / Auxiliary switch	Clamp terminal M3.5			Clamp terminal M3.5			Faston terminal #110			
Main body mounting method		Surface, DIN rail mounting Flush panel mounting (option)			Surface, DIN rail mounting			Panel mounting			
Marine approval (NK)		—	● *3		—			—			
International standard		UL, CSA			—			UL *3	—		
CE marking		● *3			—			● *3			

* 1 . Specify if for DC use when ordering

* 2 . In case of DC use, only DC65V is available.

* 3 . Specify when ordering. (In case of CP-S UL, type name is CP-SU.)

SPECIAL PURPOSE BREAKERS

MAG ONLY, DC-USE AND DSN-TYPE

Mag Only (Instantaneous tripping circuit breakers)

Fixed	NF50-CP/HP	AC, DC	Rated current x10	
	NF60-CP/HP	AC, DC		
	NF100-CP/SP/HP	AC, DC		
	NF160-SP/HP	AC, DC		
	NF250-CP/SP/HP	AC, DC		
	NF400-CP/SP NF630-CP	AC, DC		
Adjustable	NF630-SP	AC, DC	High: Rated current x10 Low: Rated current x4	
	NF800-SEP	AC	High: Rated current x10 Low: Rated current x2	
	NF800-SDP	DC	High: 8000A Low: 3200A	

Note: Standard are fixed type models. Adjustable type can be made to order.
Remarks: 1. The size, weight, accessories, etc., are all identical to the same-designation C and S series breakers.
2. For more detail, contact your dealer.

DC-Use MCCBs and DSN-type Switches

Breaking is more difficult with direct currents because the current value never reaches zero. While ordinary DC breakers are suitable for low voltages, special voltage DC breakers are recommended for voltages in excess of 250VDC. Breakers for 550V are all 4-pole models.

The size, shape, drilling plan, accessories, etc., are all identical to the S series of same-designation breakers.

Wiring diagram for DC-usage.

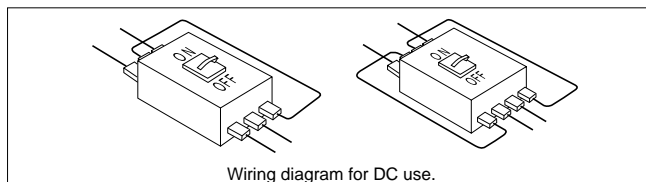

Note: The tripping characteristics will change if the wiring differs from the one shown here.

Type	NF50-HP		NF60-HP		NF100-SP		NF160-SP		NF250-SP		NF400-SP		NF630-SP		NF800-SDP	
Number of poles	3	4	3	4	3	4	3	4	3	4	3	4	3	4	3	4
Rated voltage (VDC)	400	550	400	550	440	550	440	550	440	550	440	550	440	550	440	550
Rated breaking capacity (kA) IEC 60947-2 (ICU/ICS)	2/1		2/1		10/5		15/8		15/8		40/40		40/40		40/40	

Notes: 1: Time constant: 10ms or below.

● DC side

These breakers are designed as thyristor-Leonard system DC-side breakers. They protect the thyristor from short circuiting when there is a power or

communication failure. (Mag-Only breakers can also be used for this role.) Use these breakers in combination with fast fuses for even greater protection.

Type	NF100-SP		NF160-SP		NF250-SP		NF400-SP		NF630-SP		NF800-SDP	
Number of poles	2	3	2	3	2	3	2	3	2	3	2	3
Rated voltage (VDC)	250	440	250	440	250	440	250	440	250	440	250	440
Interrupting capacity (kA)	15	10	20		20		20		20		20	
Instantaneous trip current (min.)	3 times rated current		700A		700A		900A		1000A		1400A	

● DSN-type switches

These are standard MCCBs without the automatic tripping element. The tripping capacity is about six times the rated current.

The appearance, size, drilling plan and available accessories are all identical to similar type standard S and C series MCCBs.

Type	DSN30-CS		DSN50-CP		DSN100-CP		DSN250-CP		DSN400-CP		DSN630-CP		DSN800-CP	
Rated current (A)	30		50		100		250		400		630		800	
Number of poles	2	3	2	3	2	3	2	3	2	3	3	3	3	3
Rated voltage (AC/DC)	460/—		500/250		500/250		500/250		600/250		600/250		600/250	
Max. switching current (AC/DC)	180/—		300/125		600/250		1350/560		2400/1000		3780/1575		4800/2000	

Type	DSN30-SP		DSN50-SS			DSN50-HP			DSN100-SP			DSN250-SP			DSN400-SP			DSN630-SP		DSN800-SP	
Rated current (A)	30		50			100			250			400			630		800				
Number of poles	2	3	1	2	3	4	2	3	4	2	3	4	2	3	4	3	4	3	4		
Rated voltage (AC/DC)	500/250		265/125			500/250			500/250			500/250			690/250		690/250		690/250		
Max. switching current (AC/DC)	180/75		300/125			600/250			1350/560			2400/1000			3780/1575		4800/2000				

SPECIAL PURPOSE BREAKERS

400HZ-USE, INSTANTANEOUS AND GENERATOR PROTECTION

400Hz-Use MCCBs

The tripping characteristics for these MCCBs increase with an increase in the interrupted current instantaneous trip operating current. For this reason, these breakers are recommended for use in high-frequency circuits.

● Specifications

The appearance, size, rated interrupting capacity, drilling plan, accessories, etc., are all identical to the standard S series of same-designation breakers.

Type	NF100-SP	NF100-HP	NF250-SP	NF250-SEP	NF250-HP	NF400-SP	NF400-SEP	NF630-SP ^{*1}	NF630-SEP	NF800-SEP
Rated current (A)	15, 20, 30, 40, 50, 60, 75, 100	15, 20, 30, 40, 50, 60, 75, 100	125, 150, 175, 200	125, 150, 175, 200 adjustable	125, 150, 175, 200	225, 250, 300, 350	200-350 adjustable	400, 500	300-500 adjustable	400-600 adjustable
Number of poles	2 3 4	2 3 4	2 3 4	3 4	2 3 4	2 3 4	3 4	3 4	3 4	3 4
Rated insulation voltage (VDC)	690									
Rated breaking capacity (kA)	600V	15/8	30/15	15/8	15/8	30/8	30/30	30/30	30/30	30/30
	440V	25/13	50/25	25/13	25/13	50/13	42/42	42/42	42/42	42/42
IEC60947-2 (ICU/ICS)	400V	30/15	50/25	30/15	30/15	50/13	45/45	45/45	45/45	45/45
	230V	50/25	100/50	50/25	50/25	100/25	85/85	85/85	85/85	85/85

Note *1. Instantaneous trip current : Rated current x 14 (Fix)

Low-Instantaneous MCCBs

● Low-Inst. MCCBs for Discrimination

When a power fuse (PF) is used for high-voltage protection, make sure that the MCCB on the secondary side is compatible.

Type	NF100-CP	NF100-SP	NF250-CP	NF250-SP	NF400-CP
Number of poles	2 3	2 3 4	2 3	2 3 4	2 3
Rated current (A)	50, 60, 75, 100	15, 20, 30, 40, 50, 60, 75, 100	125, 150, 175, 200, 225, 250	125, 150, 175, 200, 225, 250	250, 300, 350, 400
Instantaneous trip (% of rated current)	600	●	●	●	●
	400	—	—	●	●

Remarks: 1. Ensure compatibility with motor, etc., before use to prevent accidental tripping at start up.
2. Specify rated current and tripping characteristic.
3. There are no short time delay characteristics.

● Specifications

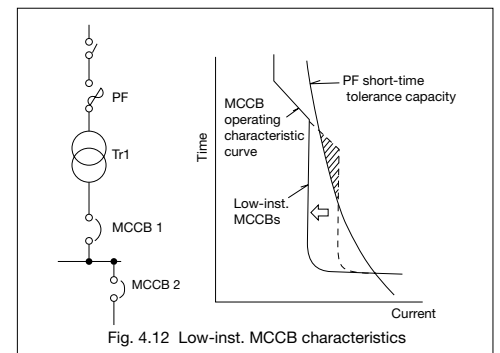

The appearance, size, rated interrupting capacity, accessories, etc., are all identical to the standard instantaneous trip breakers of the same designation.

Generator-Protection MCCBs

These breakers are designed for generator protection.

● Specifications

Type	NF100-SEP	NF100-HEP	NF250-SEP	NF250-HEP
Number of poles	3	3	3	3
Rated current (A)	(15~20) 30~50, 60~100 adjustable	(15~20) 30~50, 60~100 adjustable	125~250 adjustable	125~250 adjustable
Instantaneous trip (% of rated current)	300			*1
Operating time at 150% of rated current (s)	18~28			*1
Rated insulation voltage (V)	690			
Rated breaking capacity (kA)	AC690V	—	5/3	—
	AC500V	15/8	30/15	15/8
	AC440V	25/13	50/25	25/13
	AC400V	30/15	50/25	30/15
	AC230V	50/25	100/50	50/25

*1: These MCCBs operating characteristic must be adjusted as follows.
STD ≤ 3 (ls setting)
LTD: minimum setting (TL = 12sec setting)

CONNECTION





TYPES AND ACCESSORIES

Connection Types

If no connection method is specified with the order, we deliver the standard fixed-installation type with front connection.

The front-connection model can be modified to other types (excluding plug-in) with special purchase options.

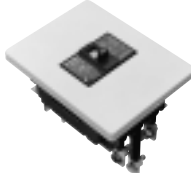
● Connection Types

Installation Connection	Fixed		Flush	Plug-in	
	Front (F)	Rear (B)	Rear (FP)	Front (DPM)	Rear (PM)
Appearance					

● Connection Accessories

Type		Rear studs (B-ST)	Flush (FP)	Plug-in (PM)
NF30-SP, NF50-CP/HP, NF60-CP/HP	2P	ST-05SP2	FP-05SP2	PM-05SP2
	3P			
MB30-SP, MB50-CP/SP, MN50-CP/SP	3P	ST-06SP3	FP-05SP3	PM-05SP3
NV50-CP, NV60-CP, NV50-HP, NV60-HP	3P			
NF50-HP, NF60-HP	4P	ST-05SP4	FP-05SP4	PM-05SP4
NF100-CP/SP	2P	ST-1SP2	FP-1SP2	PM-1SP2
NF50-HRP, NF100-HP, NF100-CP T/A, NF100-SP T/A, NF100-HP T/A	2P	ST-1HP2	FP-1HP2	PM-1HP2
NF100-CP/SP, NF100-SEP, NV100-CP/SP, NV100-SEP, MB100-SP, MN100-SP, NF100-CP T/A, NF100-SP T/A, NF100-HP T/A	3P	ST-1SP3	FP-1SP3	PM-1SP3
NF50-HRP, NF100-HP, NF100-HEP, NV100-HP, NV100-HEP	3P	ST-1SP3	FP-1HP3	PM-1SP3
NF100-SP, NF100-SEP, NV100-SEP, NF100-SP T/A,	4P	ST-1SP4	FP-1SP4	PM-1SP4
NF100-HP, NF100-HEP, NF100-HP T/A, NV100-HEP	4P	ST-1SP4	FP-1HP4	PM-1SP4
NF100-RP, NF100-UP	2P	ST-1HP2	FP-1UP2	PM-1UP2
NF100-RP, NF100-UP, NV100-RP	3P	ST-1SP3	FP-1UP3	PM-1UP3
NF100-UP	4P	ST-1SP4	FP-1UP4	—
NF250-CP/SP, NF160-SP, NF250-CP T/A, NF160-SP T/A, NF250-SP T/A	2P		FP-2SP2	
NF160-HP, NF250-HP, NF160-HP T/A, NF250-HP T/A	2P	ST-2SP2	FP-2HP2	PM-2SP2
NF250-CP/SP, NF250-SEP, NV225-CP/SP, NV225-SEP, MB225-SP, MN225-SP, NF250-CP T/A, NF250-SP T/A, NF160-SP, NF160-T/A	3P		FP-2SP3	
NF250-HP, NF250-HEP, NV225-HP, NV225-HEP, NF160-HP, NF250-HP T/A, NF160-HP T/A	3P	ST-2SP3	FP-2HP3	PM-2SP3
NF250-SP, NF250-SEP, NV225-SEP, NF160-SP, NF160-SP T/A, NF250-SP T/A	4P		FP-2SP4	
NF250-HP, NF250-HEP, NV225-HEP, NF160-HP, NF250-HP T/A, NF160-HP T/A	4P	ST-2SP4	FP-2HP4	PM-2SP4
NF225-RP, NF225-UP	2P	ST-2SP2	FP-2UP2	PM-2SP2
NF225-RP, NF225-UP, NV225-RP	3P	ST-2SP3	FP-2UP3	PM-2SP3
NF225-UP	4P	ST-2SP4	FP-2UP4	PM-2SP4
NF400-CP/SP	2P	ST-4SP2		PM-4SP2
NF400-CP/SP/SEP, NV400-CP/SP/SEP	3P	ST-4SP3	FP-4SP3	PM-4SP3
NF400-HEP/REP, NV400-HEP/REP	3P		FP-4HP3	
NF400-SP/SEP, NV400-SEP	4P		FP-4SP4	PM-4SP4
NF400-HEP	4P	ST-4SP4	FP-4HP4	
NF630-CP/SP	2P	ST-6SP2		PM-6SP2
NF630-CP/SP/SEP, NV630-CP/SP/SEP	3P	ST-6SP3	FP-6SP3	PM-6SP3
NF630-HEP/REP, NV630-HEP	3P		FP-6HP3	
NF630-SP/SEP, NV630-SEP	4P		FP-6SP4	PM-6SP4
NF630-HEP	4P	ST-6SP4	FP-6HP4	
NF800-SDP	2P	ST-8SP2		PM-8SP2
NF800-CEP/SEP, NV800-SEP	3P	ST-8SP3	FP-6SP3	PM-8SP3
NF800-HEP/REP, NV800-HEP	3P		FP-6HP3	
NF800-SEP	4P		FP-6SP4	PM-8SP4
NF800-HEP	4P	ST-8SP4	FP-6HP4	

Line and load must be connected as shown in figure (a).

For MCCBs, line and load may also be connected in reverse as shown in figure (b).

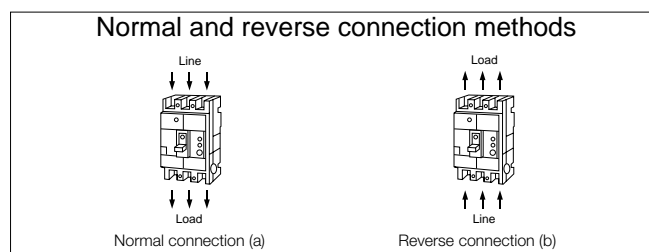

ACCESSORIES

INTERNAL

Cassette-Type Internal Accessories

Internal accessories	Function	Applicable models	Connection type	
			Lead-wire terminal block	Flying leads
AL (Alarm switch)	Indicates that the breaker has tripped.	NF-C/S/U, NV-C/S and MB series	●	●
AX (Auxiliary switch)	Indicates whether the breaker is ON or OFF.		●	●
SHT (Shunt trip)	Trips the breaker electrically by remote. Allowable tripping voltage is 70% to 110% of the rated voltage for both AC and DC. NF-C/S/U, NV-C/S and MB series	NF-C/S/U, NV-C/S and MB series	(NF30-250)	(NF30-250)
			(NF/NV400-800)	(NF/NV400-800)
UVT (Undervoltage trip)	Trips the breaker automatically when the voltage drops. The tripping voltage is 35% to 70% of the UVT rated voltage. When the voltage recovers to 85% of the rated voltage or above, the UVT can be reset and the breaker closed.		(NF30-250)	—
			(NF/NV400-800)	—





Remark: Cassette-type accessories are field-mountable type. They are available for individual purchase.

Built-In Internal Accessories



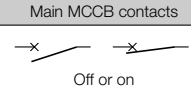

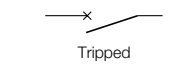
Internal accessories	Function	Applicable models	Connection type	
			Lead-wire terminal block	Flying leads
EAL (Earth-leakage alarm switch)	Indicates that the breaker has been tripped by earth leakage. (Only available with lead-wire terminal block.)	NV-C/S/U and MN series	●	(NV30-225) — (NV400-800)
TBM (Test button module)	Applies a test voltage by remote.		●	—
MG (Insulation switch)	When installed on an earth-leakage circuit breaker, it allows the load side insulation resistance to be measured while the breaker is off.		●	—
PAL (Pre-alarm module)	Indicates that the load current exceeds the pre-alarm setting current.	Electronic Types	●	—
OAL (Overcurrent trip alarm switch)	Indicates that the breaker has been tripped by overcurrent or short-circuit current.		—	NF/NV400-800-SEP ●

Switching Operation

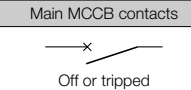

● Alarm Switch (AL) Operation

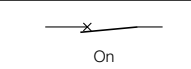
Main MCCB contacts	Alarm contacts
 <p>Off or on</p>	 <p>ALa (open) ALb (closed) ALc</p> <p>*1 (DC+)</p>
 <p>Tripped</p>	 <p>ALa (closed) ALb (open) ALc</p> <p>*1 (DC+)</p>



● Auxiliary Switch (AX) Operation

Main MCCB contacts	Auxiliary contacts
 <p>Off or tripped</p>	 <p>AXa (open) AXb (closed) AXc</p> <p>*1 (DC+)</p>
 <p>On</p>	 <p>AXa (closed) AXb (open) AXc</p> <p>*1 (DC+)</p>

● Earth-Leakage Alarm (EAL) Operation

Main ELCB conditions	Earth-leakage alarm contacts	
Overcurrent, short circuit trip or on or off	225A frame or less	 <p>EALa (open) EALc</p>
	400A frame or more	 <p>EALa (open) EALb (closed) EALc</p>
	Ground-fault trip	225A frame or less
400A frame or more		 <p>EALa (closed) EALb (open) EALc</p>

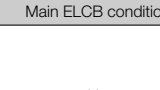
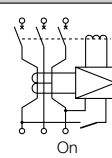
● Meggering Switch (MG) Operation

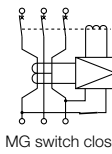
Main ELCB conditions	MG switch condition
 <p>Off or trip</p>	 <p>On</p>
 <p>Insulation switch open</p>	 <p>MG switch closed</p>

● AL, AX Switch Capacities

Micro-switch used	AC			DC		
	Voltage (V)	Amps (A)		Voltage (V)	Amps (A)	
		Resistive load	Inductive load		Resistive load	Inductive load
S	460	—	—	250	0.2	0.2
	250	3	2	125	0.4	0.4
	125	5	3	30	4	3
V	460	5	2	250	0.3	0.3
	250	10	10	125	0.6	0.6
	125	10	10	30	10	6
X*1	460	5	2.5	250	5	3
	250	10	10	125	10	6
	125	10	10	30	10	10

NOTE: *1. When DC use polarity must be considered.

Maximum Number of Internally Mounted Accessories

● MCCBs



Type	NF-C/S	NF30-CS	NF30-SP NF50-CP/HP NF60-CP/HP NF100-CP/SP	NF30-SP NF50-CP/HP NF60-CP/HP NF100-CP/SP NF50-HRP NF250-CP/SP/HP NF100-HP NF160-SP/HP	NF100-SEP NF100-HEP NF250-SEP NF250-HEP
	NF-U			NF100-RP/UP NF225-RP/UP	
MB				MB30-SP MB50-CP/SP MB100-SP MB225-SP	
Pole		2, 3	2	2, 3, 4	3, 4
Switch type	S				
Accessories	AL				
	AX				
	SHT or UVT				
	AL + AX				
	AL + SHT or UVT				
	AX + SHT or UVT				
	AL + AX + SHT or UVT				
	PAL				

The number within the circle shows the order of mounting.
 * 1. Only lead-wire type available (LT or SLT is not applicable).
 * 2. UVT mounting requires a UVT voltage module (SHT requires no such voltage module).
 * 3. UVT unavailable.
 * 4. PAL breakers signal an alarm at 70% to 100% of the rated current setting. Control voltage (AC 100-200V) is required.

ACCESSORIES

INTERNAL

Maximum Number of Internally Mounted Accessories

● MCCBs



Type	NF-C/S	NF400-CP/SP NF400-SEP/HEP/REP	NF630-CP/SP NF630-SEP/HEP/REP NF800-CEP/SDP NF800-SEP/HEP/REP	
	NF-U	NF400-UEP (3P)	NF400-UEP (4P), NF630-UEP, NF800-UEP	
Poles	2, 3, 4			
Switch type	S			
Accessories	AL			*3
	AX			*3
	SHT or UVT			*1 *2
	AL + AX			*3
	AL + SHT or UVT			*1 *2 *3 *4
	AX + SHT or UVT			*1 *2 *3 *4
	AL + AX + SHT or UVT			*1 *2 *3 *4
	PAL (contact output)			*5
		Option for NF400-SEP/HEP/REP/UEP	Option for NF630-SEP/HEP/REP/UEP NF800-CEP/SEP/HEP/REP/UEP	*5
	TI			*6
	Option for NF400-SEP/HEP/REP/UEP	Option for NF630-SEP/HEP/REP/UEP NF800-CEP/SEP/HEP/REP/UEP	*6	

The number within the circle shows the order of mounting.

*1. SHT and UVT are right-pole mounting as standard. Please specify if left-pole mounting is required.

*2. UVT mounting requires a UVT voltage module (SHT requires no such voltage module).

*3. When mounting more than three left-pole mounting devices by SLT, or when mounting a SHT or UVT to the same pole as the AL, AX or AL + AX, a special-order SLT is necessary.

*4. When mounting a UVT to the same pole as the AL, AX, or AL + AX, the UVT voltage module is separate.

*5. SLT-equipped is standard. Control voltage (AC100-200V) is necessary. (In this case, no other accessories can be mounted to the breaker's right pole.)

*6. SLT-equipped is standard. Control voltage (AC100-200V/DC100-200V) is necessary. (In this case, no other accessories can be mounted to the breaker's right pole.)

● ELCBs



Type	NV-C/S	NV30-CS	NV30-SP NV50-CP/HP NV60-CP/HP NV100-CP/SP/HP NV225-CP/SP/HP NV100-RP NV225-RP	NV100-SEP NV100-HEP NV225-SEP NV225-HEP
	MN	MN30-CS	MN50-CP/SP MN100-SP MN225-SP	-
Poles	3			3, 4
Switch type	S			
Accessories	AL			
	AX			
	MG			
	AL + AX			
	AL + MG			
	EAL			
	TBL			
	TBM			
	PAL			

The number within the circle shows the order of mounting.
 1. EAL, TBL, TBM and PAL can be mounted regardless of the number of AL, AX and MG accessories.
 2. With auto reset for electrical operation, the number of AL switches is reduced by one.
 * Control supply voltage is required (EAL, PAL: AC100-200V, TBM: 100-240V AC/DC common).

ACCESSORIES

INTERNAL

Maximum Number of Internally Mounted Accessories

● ELCBs



Type	NV-C/S	NV400-CP/SP NV400-SEP/HEP/REP	NV630-CP/SP NV630-SEP/HEP NV800-SEP/HEP	
Poles		3, 4		
Switch type		S		
Accessories	AL			*2
	AX			*2
	SHT or UVT			*1
	AL + AX			*2
	AL + SHT or UVT			*1 *2 *3
	AX + SHT or UVT			*1 *2 *3
	AL + AX + SHT or UVT			*1 *2 *3
	MG			
	AL + MG			

The number within the circle shows the order of mounting.

*1. UVT mounting requires a UVT voltage module (SHT requires no such voltage module).

*2. When mounting more than three left-pole mounting devices by SLT, or when mounting a SHT or UVT to the same pole as the AL, AX or AL + AX, a special-order SLT is necessary.

*3. When mounting a UVT to the same pole as the AL, AX or AL + AX, the UVT voltage module is separate.

● ELCBs



Type	NV-C/S	NV400-CP/SP NV400-SEP/HEP/REP	NV630-CP/SP NV630-SEP/HEP NV800-SEP/HEP
Poles		3, 4	
Switch type		S	
Accessories	AX + MG		
	AL + AX + MG		
	EAL		
	TBL		
	TBM		
	PAL (contact output)		
	TI		

The number within the circle shows the order of mounting.

1. EAL, TBL, and TBM can be mounted regardless of the number of AL, AX, SHT, UVT and MG accessories. (However, two EALs, TBLs or TBMs cannot be mounted simultaneously.)

2. The PAL's dimensions and specifications change for the NF-C/S and NV-C/S series.

*1. SLT-equipped is standard. Control voltage (AC100-200V) is necessary. (In this case, no other accessories can be mounted to the breaker's right pole.)

*2. SLT-equipped is standard. Control voltage (AC100-200V/DC100-200V) is necessary. (In this case, no other accessories can be mounted to the breaker's right pole.)

ACCESSORIES

INTERNAL

SHT (Shunt Trip Device)

● Coil Ratings

MCCB type	Cut-off switch	Voltage (V)	Input VA *1		Operating time (ms) *2
			AC	DC	
NF30-SP, NF50-CP/HP, NF50-HRP, NF60-CP/HP, NF100-CP/SP/HP, NF100-SEP/HEP, NF100-RP/UP, MB30-SP, MB50-CP/SP, MB100-SP	Equipped	AC100-120 200-240 380-450 (50 also 60Hz) DC100	120	50	5~15
NF160-SP/HP, NF250-CP/SP/HP, NF250-SEP/HEP, NF225-RP/UP, MB225-SP		60			
NF400-CP/SP/SEP/HEP/REP, NF630-CP/SP/SEP/HEP/REP, NF800-SDP/CEP/SEP/HEP/REP, NF400-UEP, NF630-UEP, NF800-UEP, NF400-CP/SP/SEP/HEP/REP, NV630-CP/SP/SEP/HEP, NV800-SEP/HEP		AC100~450/DC100~200 (50 also 60Hz)	100V : 20 200V : 50 330V : 120 450V : 170	100V : 10 200V : 35	5~15

*1. Any voltage drops in the input electric power must not exceed the allowable operating voltage range for the SHT operating power capacity.

*2. The operating time includes the time up to the moment the breaker's main contact disconnects after a voltage has been applied to the shunt trip device.

● Coil Ratings (List of manufacturable special voltages)

MCCB type	AC (V)				DC (V)							AC/DC (V)
	24	48	380 ~550	440 ~550	12	24	36	48	110	125	220	24 ~48
NF30-SP, NF50-CP/HP, NF50-HRP, NF60-CP/HP, NF100-CP/SP/HP, NF100-SEP/HEP, NF100-RP/UP, NF160-SP/HP, NF250-CP/SP/HP, NF250-SEP/HEP, NF225-RP/UP, MB30-SP, MB50-CP/SP, MB100-SP, MB225-SP	●	●	—	●	●	●	●	●	●	●	●	—
NF400-CP/SP/SEP/HEP/REP, NF630-CP/SP/SEP/HEP/REP, NF800-SDP/CEP/SEP/HEP/REP, NF400-UEP, NF630-UEP, NF800-UEP, NV400-CP/SP/SEP/HEP/REP, NV630-CP/SP/SEP/HEP, NV800-SEP/HEP	—	—	●	—	●	—	—	—	—	—	—	●

UVT (Undervoltage Tripping Device)

● Coil Ratings

MCCB type	Specification		Coil rating			
	For synch. closing	For electrical interlock	Voltage V		Input VA	Operating time (T/sec) *2
			Standard voltage	Special voltage *1		
NF30-SP, NF50-CP/HP, NF50-HRP, NF60-CP/HP, NF100-CP/SP/SEP/HP/HEP/RP/UP, NF250-CP/SP/SEP/HP/HEP, NF225-RP/UP, MB30-SP, MB50-CP/SP/HC, MB100-SP, MB225-SP	● (*4)	▲	AC100-110 (*3) 200-220 400-440 DC100	AC110-120 (*3) 220-240 380-415 440-480 500-550 DC24 48 110	5	5~30
NF400-CP/SP/SEP/HEP/REP/UEP, NF630-CP/SP/SEP/HEP/REP/UEP, NF800-CEP/SDP/SEP/HEP/REP/UEP, NV400-CP/SP/SEP/HEP/REP, NV630-CP/SP/SEP/HEP, NV800-SEP/HEP	●	▲ (*5)				

*1. Rated voltage differs according to make and country of manufacture. Please consult your dealer.

*2. The operating time is the time from the start of operating the breaker since the undervoltage trip went from voltage to no-voltage condition.

*3. 50Hz and 60Hz for common use.

*4. When the breaker is turned on without exciting to UVT (no-voltage condition), the contact of breaker tips (close momentary).

*5. Mounts to the left pole.

Vertical Lead-wire Terminal block (SLT)

- Makes possible contact installation between terminal block and breaker.
- No need for correspondent terminal.
- Staggered arrangement of terminal screws makes wiring easier.
- It's also easier to perform a check for tightness of the terminal screws.
- Terminal cover for the terminal block is standard (included).
- Terminal covers come in front, rear, and plug-in connection types.



● MCCBs

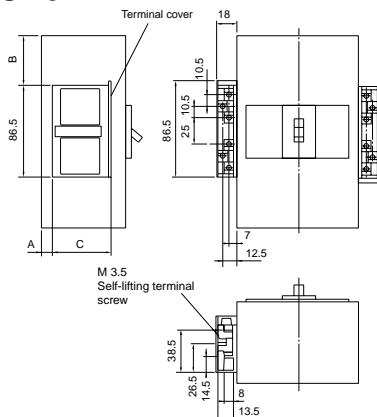

● ELCBs

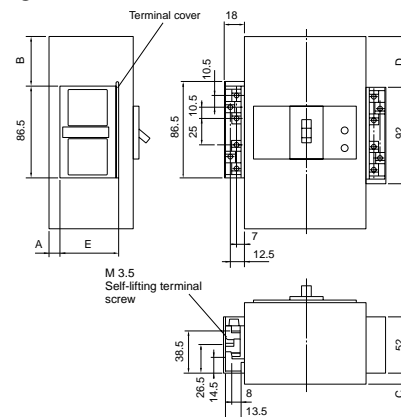

Key to dimensions

MCCB type	A	B	C
NF30-CS	4	4.5	44.5
NF30-SP, NF50-CP/HP, NF60-CP/HP, MB30-SP, MB50-CP/SP	7	17.5	54
NF50-HRP, NF100-CP/SP/HP, NF100-SEP/HEP, MB100-SP	7	30	
NF100-RP/UP		91	
NF160-SP/HP, NF250-CP/SP/HP, NF250-SEP/HEP, MB225-SP		37	
NF225-RP/UP		112	
NF400-CP/SP/SEP/HEP/REP	41	79.5	
NF400-UEP (3P)	138	119.5	
NF630-CP/SP/SEP/HEP/REP, NF800-SDP/CEP/SEP/HEP/REP	41	88.5	
NF400-UEP (4P), NF630-UEP, N800-UEP	138	135.5	

* Tightening torque for terminal screws: M3.5 0.9~1.2 N•m

Key to dimensions

ELCB type	A	B	C	D	E
NV30-CS, MN30-CS	4	4.5	—	—	44.5
NV30-SP, NV50-CP/HP, NV60-CP/HP, MN50-CP/SP	7	17.5	3.5	21.5	54
NV100-CP/SP/HP, NV100-SEP/HEP, MN100-SP		30	2.5	30	
NV100-RP		91	2.5	91	
NV225-CP/SP/HP, NV225-SEP/HEP, MN225-SP		37	2.5	37	
NV225-RP		112	2.5	112	
NV400-CP/SP/SEP/HEP/REP		41	79.5	26.5	
NV630-CP/SP/SEP/HEP, NV800-SEP/HEP	41	88.5	26.5	88.5	

* Tightening torque for terminal screws: M3.5 0.9~1.2 N•m

● 14 Terminal (SLT)

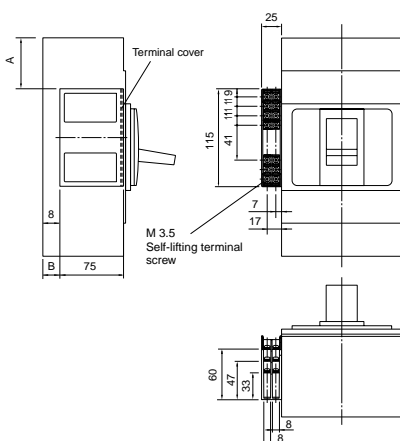

Key to dimensions

MCCB	ELCB	A	B
NF400-CP/SP/SEP/HEP/REP	NV400-CP/SP/SEP/HEP/REP	20	60
NF400-UEP (3P)	—	117	100
NF630-CP/SP/SEP/HEP/REP NF800-SDP/SEP/HEP/REP	NV630-CP/SP/SEP/HEP NV800-SEP/HEP	20	69
NF400-UEP (4P), NF630-UEP NF800-UEP	—	117	116

* Tightening torque for terminal screws: M3.5 0.9~1.2 N•m

ACCESSORIES

INTERNAL

Pre-Alarm Module (PAL-M)

This module functions to give alarm output when load current exceeds a preset current level and serves for securing continuous power supply and also for preventive maintenance. The electronic breakers with mount digital ETR of 100 to 800AF

are provided with this module as an option. (Some modules are with this module as standard equipment.) 1000 to 2000AF are prepared for exclusive use.

Type	Pre-alarm LED (Auto reset)	Solid state relay (SSR) output-Contacties output (Auto reset)		Pre-alarm module-Contact output (1a)		
		Standard equipment	Switching capacity	(Self-holding)	Switching capacity	Reset system
NF100-SEP NF100-HEP	Standard equipment	Standard equipment	24VDC 100-200VAC 20mA	Option	100VAC or 200VAC 2A	Press the reset switch or turn off control power.
NF250-SEP NF250-HEP						
NV100-SEP NV100-HEP		—				
NV225-SEP NV225-HEP		—				
NF400-SEP NF400-HEP NF400-REP		Standard equipment	24VDC 100-200VAC 20mA			
NF400-UEP NF630-SEP NF630-HEP						
NF630-REP NF630-UEP NF800-CEP		Standard equipment	24VDC 100-200VAC 20mA			
NF800-SEP NF800-HEP NF800-REP						
NF800-UEP						
NV400-SEP NV400-HEP NV400-REP						
NV630-SEP NV630-HEP NV800-SEP						
NV800-HEP						

- ① Pre-alarm LED
The LED starts blinking on the circuit breaker when load current exceeds the preset current, then changes to continuous glowing when pre-alarm output is given.
- ② Solid-state relay output
Open the upper cover of the circuit breaker, connect the connector of the lead wire packed together and use it as the lead wire outlet. In this case, only the lead wire outlet of the internal accessories can be attached to the right pole. (For flush plate type, the outlet is manufactured in advanced as a PAL mount.)
- ③ Pre-alarm module
SLT is attached as standard and is used as the control power source of 100VAC or 200VAC. In this case, no other internal accessories can be attached to the right pole. (Auto resetting is also applicable.)

● Pre-alarm characteristics

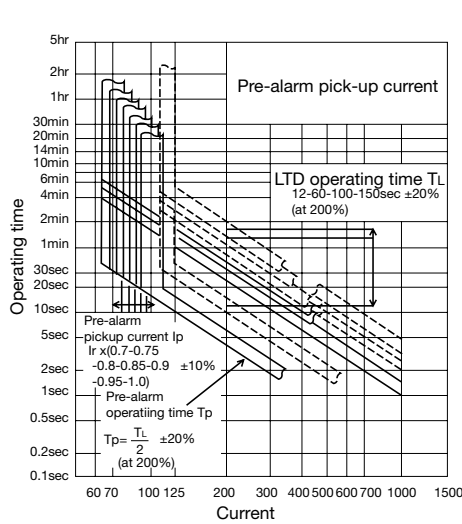

Percentage (%) to rated current or preset current rating (NF/NV100,250AF)

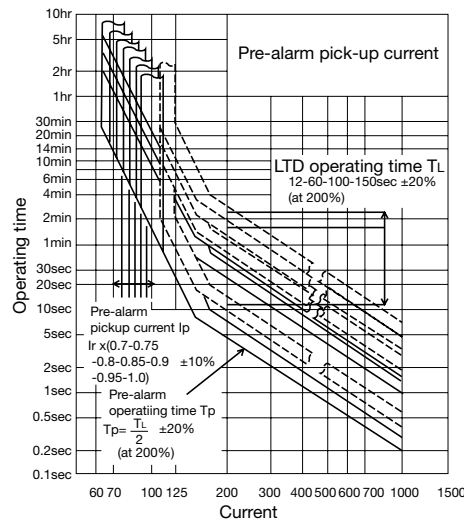

Percentage (%) to rated current or preset current rating (NF/NV400,630,800AF)

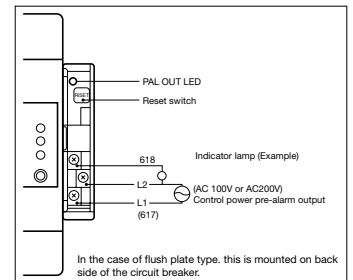

Trip Indicator (TI) New

When the breaker is tripped, this accessory installed on the right side will display the cause of the trip--either long delay (LTD) , short or instantaneous (STD/INST), earth-leakage (EAL) (with earth-leakage breakers only)--on its LED and output an alarm signal. In this case, both LTD and STD/INST are treated as overcurrent trips (OAL) and output signals. Pre-alarm is also output. Again, with this module, it is impossible to connect other internal accessories to the breaker's right side.)

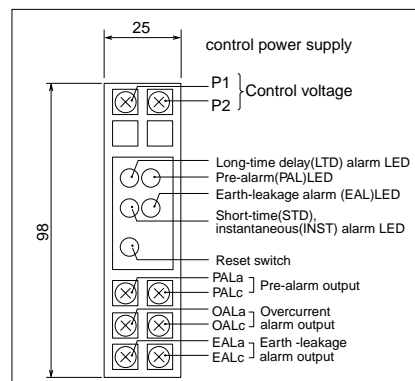

Type	LED contents
NF400-SEP/HEP/REP/UEP NF630-SEP/HEP/REP/UEP NF800-CEP/SEP/HEP/REP/UEP	Long-time delay, Short-time delay, Instantaneous, Pre-alarm
NV400-SEP/HEP/REP, NV630-SEP/HEP, NV800-SEP/HEP	Long-time delay, Short-time delay, Instantaneous, Earth-leakage, Pre-alarm

* Requires 100-200VAC control voltage.

3ø4W Neutral-pole protection Relay (NR)

● With 3-phase 4-wire circuits, the circuit's supply voltage depends on the neutral-pole tripping characteristics.

Phase/wire type		3 ø 4W				
Rated voltage	VAC	415				
Usable supply voltage	VAC	304-484				
Tripping characteristics	Usable voltage (line voltage)	VAC	380	400	415	440
	Total operating overvoltage (phase voltage) (135% of total phase voltage)	VAC	296	312	323	343
	Total non-operating overvoltage (phase voltage) (120% of total phase voltage)	VAC	263	277	288	305
	Total overvoltage operating time	(s)	1			
	Overvoltage non-operating time	(s)	More than 0.1			
Trip indication method	Button					
Reset method	Reset button (open-phase display use)					
External output contacts	1c					
	Voltage	AC		DC		
		cos φ		Voltage	L/R	
	1.0	0.4	0		0.007	
	100, 120V	7A	7A	30V	7A	6A
	200, 240V	7A	7A	125V	0.6A	0.6A
415V	5A	2A	250V	0.3A	0.3A	

Remark: Using with a shunt-trip device (SHT) equipped breaker will improve tripping and phase protection.

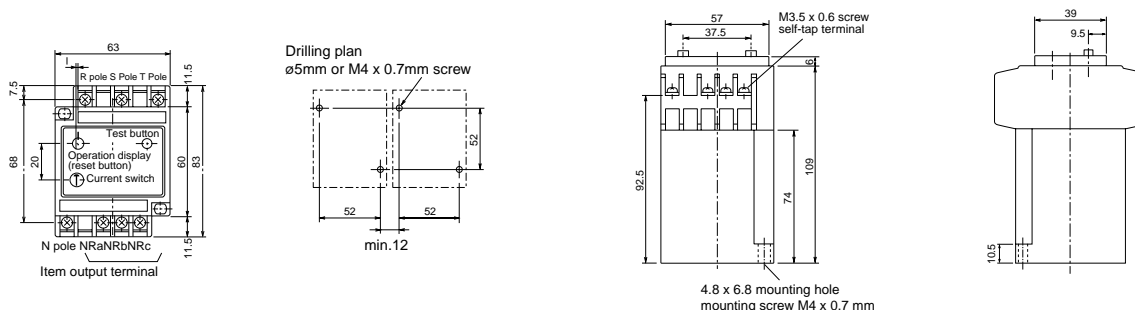

ACCESSORIES

INTERNAL

Available Soon

Measuring Display Unit (MDU)

- The measuring display unit (MDU) is for use with electronic MCCBs and ELCBs. It monitors a wide range of load current characteristics.
- The MDU can also be installed separately from the breaker main unit.
- The measured values and/or the alarm signal output can be transmitted via Mitsubishi's FA network CC-Link (option). The electric energy can be manufactured as pulsed output (option).

Product name		NF225-SPM	NF400-SEPM NF400-HEPM	NF630-SEPM NF630-HEPM	NF800-SEPM NF800-HEPM	NV225-SPM	NV400-SEPM NV400-HEPM	NV630-SEPM NV630-HEPM	NV800-SEPM NV800-HEPM	
Item	Measurement Display	Each phase load current Present value, average value, maximum average value	●	●	●	●	●	●	●	
		Each phase line voltage resent value, average value, maximum average value	●	●	●	●	●	●	●	
		Electric power Present value, maximum average value	●	●	●	●	●	●	●	
		Electric power One-hour value Present value, maximum average value	●	●	●	●	●	●	●	
		Electric energy Accumulated total value	●	●	●	●	●	●	●	
		Power factor Present value	●	●	●	●	●	●	●	
		Higher harmonic electric current Third, fifth, seventh and total: present value, maximum average value	—	●	●	●	—	●	●	
		Total higher harmonic electric current Present value, average value, maximum average value	—	●	●	●	—	●	●	
		Earth-leakage current	—	—	—	—	●	●	●	
		Fault current/cause #1	—	●	●	●	—	●	●	
		Load current measurement range	338A	800A	1260A	1600A	338A	800A	1260A	1600A
		Time interval (average)	0~15min., selectable in 1min. units							
		Earth-leakage fault current measurement range	—				Maximum sensitivity current x 2			
		Voltage measurement range	690V	690V	690V	690V	484V	484V	484V	484V
Alarm (LED display) *2	Pre-alarm PAL (auto reset) *3	—	●	●	●	—	●	●	●	
	Earth-leakage pre-alarm EPAL (auto reset) *4	—	—	—	—	—	●	●	●	
	Overcurrent alarm OVER	—	●	●	●	—	●	●	●	
Power supply		100/240VAC (50/60Hz), 100VDC, 200VDC								

- * 1. Fault cause can also be manufactured as contact output.
- * 2. Contact output alarm signals (PAL, EPAL) can also be made to order. (Option) The lead-wire terminal block is attached.
- * 3. Contact output self-holding alarm output can also be made to order.
- * 4. The earth-leakage pre-alarm EPAL sensitivity current is also selectable.
- * 5. Transmittable data over the CC-Link (option) include breaker measurements, displays, and alarms.

Measuring Display Unit

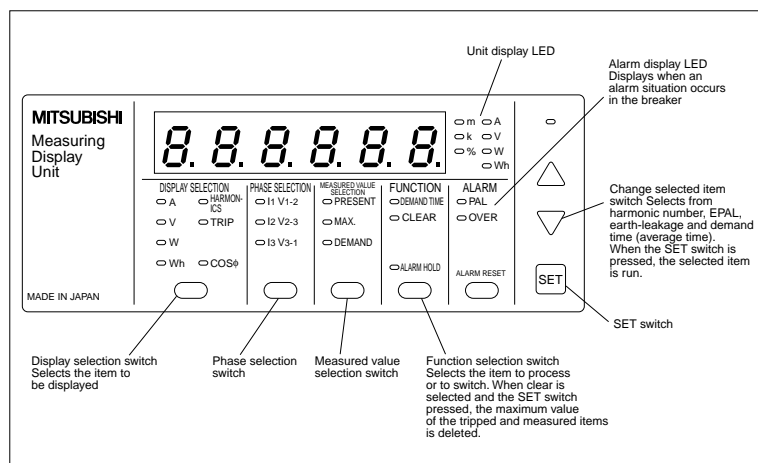

ACCESSORIES

EXTERNAL

Electrically Operated MCCBs and ELCBs



a) Motor-operated type (1)
(MD)



b) Motor-operated type (2)
(MD)



c) Spring-charged type
(MDS)

● Specifications

MCCB type	NF-C series	NF100-CP NF250-CP	NF400-CP NF630-CP NF800-CEP	NF400-CP NF630-CP NF800-CEP		
	NF-S series	NF50-HRP NF100-SP/HP NF100-SEP/HEP NF160-SP/HP NF250-SP/HP NF250-SEP/HEP	NF400-SP NF400-SEP/HEP/REP NF630-SP NF630-SEP/HEP/REP NF800-SEP/HEP/REP	NF400-SP NF400-SEP/HEP/REP NF630-SP NF630-SEP/HEP/REP NF800-SEP/HEP/REP		
	NF-U, MB series	NF100-RP NF100-UP NF225-RP NF225-UP MB100-SP MB225-SP	NF400-UEP NF630-UEP NF800-UEP	NF400-UEP NF630-UEP NF800-UEP		
ELCB type	NV-C series	NV100-CP NV225-CP	NV400-CP NV630-CP	NV400-CP NV630-CP		
	NV-S series	NV100-SP/HP NV100-SEP/HEP NV225-SP/HP NV225-SEP/HEP NV100-RP NV225-RP	NV400-SP NV400-SEP/HEP NV630-SEP/HEP NV800-SEP/HEP	NV400-SP NV400-SEP/HEP NV630-SEP/HEP NV800-SEP/HEP		
	MN series	MN100-SP MN225-SP	—	—		
Electrical operation system		Motor-operated type (1)	Motor-operated type (2)	Spring-charged type		
Rated operating voltage (V) (Allowable voltage range 85~110%) *1		100-240VAC/100-220VDC 24VDC	100/110VDC, 100/110VAC, 200/220VAC (125VDC, 240VAC)			
Operating current (A, rms)*2	DC	100/110V	0.20	3.0 (8.0)	1.0 (3.0)	8
		100/110V	0.50	4.0 (8.0)	1.0 (3.0)	8
	AC	200/220V	0.35	2.0 (4.5)	0.5 (1.5)	7
Operating time (s)	On	Less than 0.5 (self-holding)	Less than 0.3 (self-holding)	0.05		
	Off			Less than 3 (self-holding)		
Required transformer capacity (VA)		100	400	700		
Endurance voltage (V)		1500				

*1. () voltages are special options and might require an external resistor. For details, consult your dealer.
*2. () shows starting currents.

■ General precautions for motor-operated electrical MCCBs

- Motor-operated types have intermittent ratings, and therefore they should not be operated more than 10 times consecutively (one on/off counts as an operation).
- The operating voltage should be between 85~110% of the rated control voltage.
- When the breaker is tripped by trip button or breakdown (i.e., overload or short circuit), the breaker will not show that it has been tripped (except for motor-operated type 1 breakers).
- The dielectric strength of the electrical operating

circuits is 1500V. When performing a dielectric strength test simultaneously with another device at a voltage over 1500V, the operating circuit terminal should be disconnected

■ Automatic Reset

- If the breaker is an auto reset type, it contains a built-in alarm switch and the off-control circuit closes when the breaker is tripped. Since the breaker automatically resets itself after tripping, the power is easily restored by switching on the breaker again. With a UVT mounted, however, auto reset may not be possible. In this case, please consult your dealer

● Terminal connections

Connection		Front	Rear	Flush	Plug-in *1
AF	50-250	●	●	●	●
	400-800	●	●	●	●

Remarks: All 2-pole breakers are constructed by removing the central pole from the appropriate 3-pole type.
*1. For NV types, only 3-pole of 100 and 225AF available.

● Structure and Operation

■ Motor-operated type (1)

● Electrical operation

Motor rotation is changed by DC motor, gear and cam to linear motion to switch the breaker ON and OFF (reset).

● Manual operation

Set the slide switch to Manual. Insert the handle and rotate it clockwise for ON or anticlockwise for OFF (reset). After manual operation is complete, turn the slide switch back to Auto.

● Cautions during electrical operation

1. When performing ON and OFF (reset) switching, the current flow is very low (approx. 15mA, DC24V). Therefore the operating switch should be suitable for low current.

2. If the breaker has a UVT attached, do not give continuous OFF signals.

3. For automatic resetting system, use the alarm switch (for microload) of the circuit breaker and wire the operation switch circuitry (between terminals S1, S2 and S4) as shown in Fig. 1.

Notice that in a circuit without interlocking as shown in Fig. 2, application is made immediately after resetting if the circuit-breaker trips when the ON signal is applied continuously. Take care not to allow the continuous application of the ON signal.

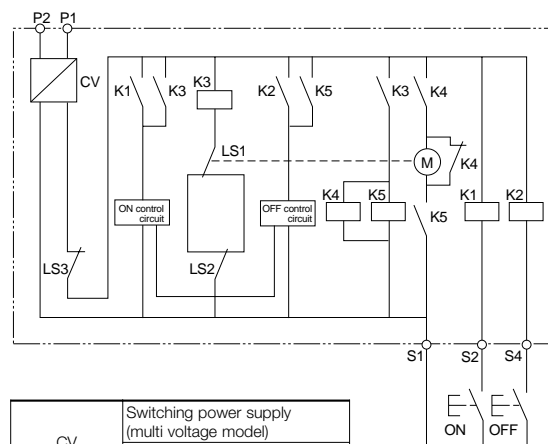
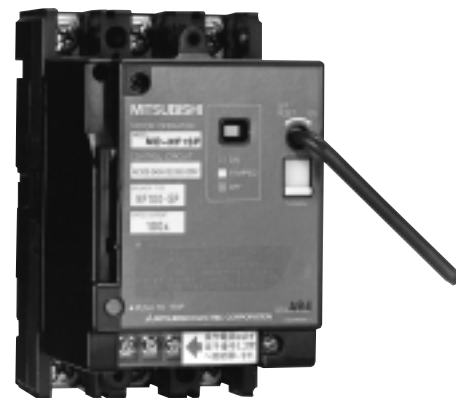

CV	Switching power supply (multi voltage model) Diode stack (24V dc model)
LS1	Limit switch (for cam position detection)
LS2	Limit switch (for breaker handle position detection)
LS3	Limit switch (MANUAL/AUTO selector)
M	Motor
K1	Relay (for ON operation)
K2	Relay (for OFF operation)
K3	Relay (for motor)
K4	Relay (for motor)
K5	Relay (for motor)

Fig.1

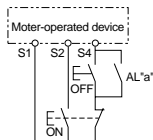
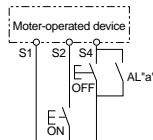

Fig.2



4. Switching the internal power supply could interfere with nearby communications equipment such as AM radio. If this is cause for concern, it's recommended that a noise filter be installed between terminals P1 and P2 and the power supply.

ACCESSORIES

EXTERNAL

Electrically Operated MCCBs and ELCBs

■ Motor-operated type (2)

- Electrical operation
Forward and reverse motor rotation is changed by ball screw to switch the breaker ON and OFF (reset).
- Manual operation
The manual operation handle can be used to switch the breaker ON and OFF directly.
- Cautions during electrical operation
 1. In case the UVT operates and a circuit breaker trips if the breaker has a UVT, the re-closing procedure may differ according to the state of the breaker before tripping.
When the circuit breaker trips while turned ON.....
Reset (OFF) -> Turn ON
When the circuit breaker trips while turned OFF.....
Turn ON (idle tripping) -> Reset (OFF) -> Turn ON
(If it fails to turn ON (idle tripping), please operate Reset (OFF) and turn ON.)
 2. Do not send ON and OFF signals consecutively. An interval of at least 0.5s is required between each ON and OFF.
 3. For models with auto reset capability, resetting after an NFB trip should be performed after an interval of 0.5s.
 4. The electrical operating device is equipped with a pumping prevention circuit. Although it is possible to set the device to OFF while it is set to ON, it is impossible to return it to ON immediately. To return to ON, first shut off the ON switch, then set it back to ON.
 5. Special care is required during electrical operation because the manual operation handle moves at high speed. Also be sure to turn off the circuit power supply when using manual operation.
 6. With manual operation, ensure that the handle is fully extended.



Manual operation

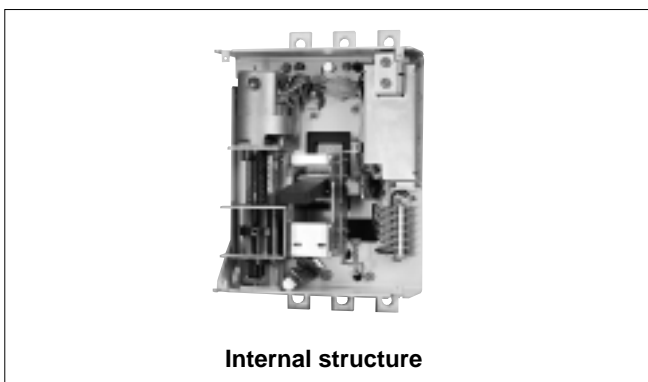

Internal structure

● Control circuit

The dotted line shows an additional connection for the automatic-reset type.

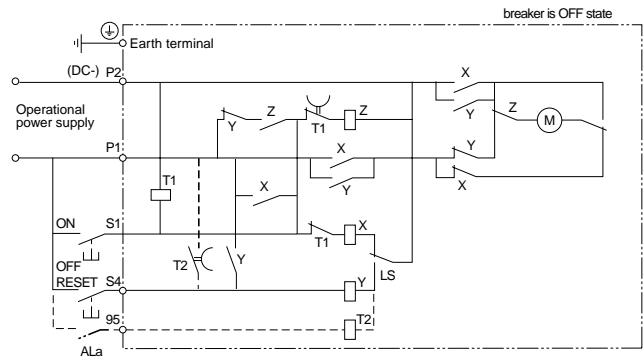

- M :Motor
- X :Relay for ON operation
- Y :Relay for OFF operation
- Z :Relay for changing Motor polarity
- T1 :Timer for antipumping
- T2 :Timer for automatic reset
- LS :Limit Switch
- ALa :Alarm switch for automatic reset (a contact)

ACCESSORIES

EXTERNAL

Mechanical Interlocks (MI)

● Front, Rear, Plug-in

With two breakers, use a panel-mounted mechanical interlock for one-way only input. A breaker-mounting mechanical to mount on the breaker main unit can be made to order. Consult your dealer for more details.

Front, Rear, Plug-in (panel mounting)

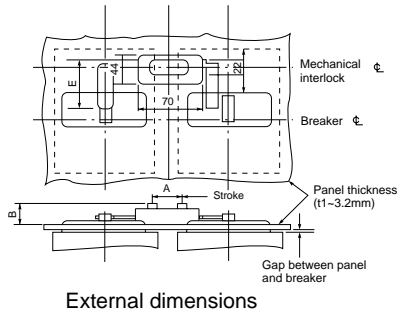

External dimensions

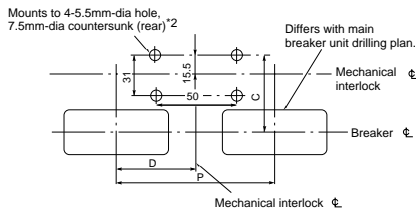

Drilling plan
Fig.1

Breaker mounting (front)

Type	F	G
MI-05SPFB3	25	111
MI-1SPFB3	30	132
MI-2SPFB3	35	126

Type	F	G	P
MI-4SPFB3	44	194	190
MI-6SPFB3	70	243	260

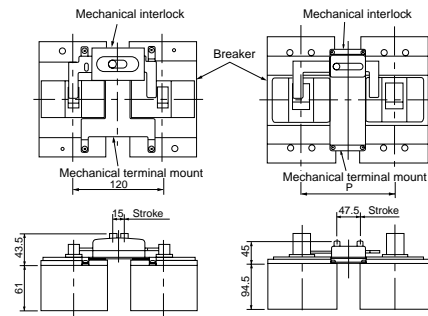

External dimensions

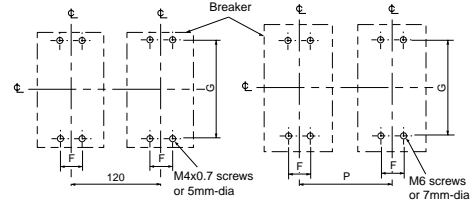

Drilling plan (breaker mount)
Fig.2 Fig.3

*1. Above 400AF, use panel thickness $t=1.6\sim 3.2\text{mm}$.
*2. When the panel thickness is greater than $t=2.3\text{mm}$, use 4-5.5mm-dia 9.5mm dia countersunk (rear).

● Table of Altered Dimensions

Breaker type		Pitch (P) *1						Dimensions (mm)						Breaker mount (*4)			
MCCB	ELCB	Standard			Special Standard	Standard		t	A	B	C (*3)	D	E	Fig.	Type	Fig.	
		Type	2P	3P	3P	Type	4P										
NF30-SP, NF50-CP/HP, NF60-CP/HP	—	MI-05SP3	120	—	—	—	—	(*2)	15	33	63	47.5	58	Fig.1	—	—	
NF30-SP, NF50-CP/HP, NF60-CP/HP, MB30-SP, MB50-CP/SP	NV30-SP, NV50-CP/HP, NV60-CP/HP, MN50-CP/SP		—	120	—	130	MI-05SP4		120	15	33	63	—		58	MI-05SPFB3	Fig.2
NF100-CP/SP	—		120	—	—	—	—		—	15	33	63	45		58	—	—
NF50-HRP, NF100-CP/SP/HP, NF100-SEP/HEP, MB100-SP	NV100-CP/SP/HP, NV100-SEP/HEP, MN100-SP	MI-05SP3	—	120	130	150	MI-1SP4	130	(*2)	15	33	63	—	58	Fig.1	MI-1SPFB3	Fig.2
NF100-RP/UP	NV100-RP		—	120	150	180	MI-2SP4	150		15	33	63	—	58		MI-2SPFB3	Fig.2
NF250-CP/SP/HP, NF250-SEP/HEP, MB225-SP	NV225-CP/SP/HP, NV225-SEP/HEP, MN225-SP	MI-05SP3	120	150	180	MI-2SP4	150	(*2)	15	33	63	—	58	Fig.1	—	—	
NF225-RP/UP	NV225-RP	—	120	150	180	MI-2SP4	150								25.5	—	58
NF400-CP/SP/SEP/HEP/REP	NV400-CP/SP/SEP/HEP/REP	MI-4SP3	190	—	210	MI-4SP4	250	(*2)	47.5	33	83.5	—	74	Fig.1	MI-4SPFB3	Fig.3	
NF400-UEP(3P)	—		—	190	—										210		MI-4SP4
NF630-CP/SP/SEP/HEP/REP, NF800-CEP/SDP/SEP/HEP/REP, NF400-UEP(4P), NF630-UEP, NF800-UEP	NV630-CP/SP/SEP/HEP, NV800-SEP/HEP	MI-6SP3	220	—	240	MI-6SP4	290	(*2)	47.5	33	83.5	—	74	Fig.1	MI-6SPFB3	Fig.3	
—	—		—	220	—										240		MI-6SP4

*1. Specify the breaker mounting pitch (P)
*2. No need to specify the panel thickness (t). (Usable panel thickness range: $t=1\sim 3.2\text{mm}$. Above 400AF, use panel thickness $t=1.6\sim 3.2\text{mm}$.)
*3. For isolation purposes with 400/630/800AF models, keep the C dimension deviation within $\pm 1\text{mm}$.
*4. Enquire for more details.
Remarks: Mechanical interlock walking type (MI-W) for electrical operating can be made to order. Consult your dealer. (Above 400AF)

● **Flush**

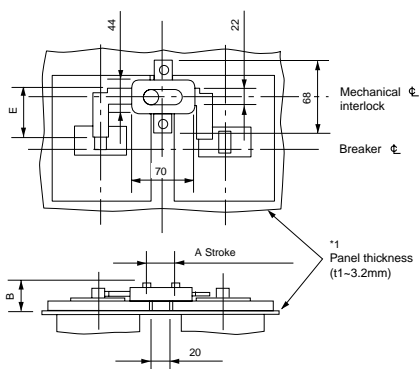

External dimensions

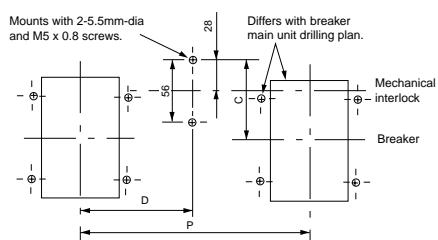

Drilling plan

Fig.4

*1. Above 400AF, use panel thickness $t=1.6-3.2\text{mm}$.

● **Table of Altered Dimensions**

Breaker type		Pitch (P) (MIN) *1				Dimensions (mm)					Fig.	
MCCB	ELCB	Standard				A	B	C	D	E		
		Type	2P	3P	Type						4P	
NF30-SP, NF50-CP/HP, NF60-CP/HP	—	MI-05SPFP3	150	—	—	—	15	49.5	75.5	62.5	58	Fig. 4
NF30-SP, NF50-CP/HP, NF60-CP/HP, MB30-SP, MB50-CP/SP	NV30-SP, NV50-CP/HP, NV60-CP/HP, MN50-CP/SP		—	150	MI-05SPFP4	175	15	49.5	75.5	—	58	
NF100-CP/SP	—	MI-1SPFP3	180	—	—	—	15	49.5	75.5	75	Fig. 4	
NF50-HRP, NF100-CP/SP/HP, NF100-SEP/HEP, MB100-SP	NV100-CP/SP/HP, NV100-SEP/HEP, MN100-SP		—	180	MI-1SPFP4	215	15	49.5	75.5	—		58
NF100-RP/UP	NV100-RP	MI-2SPFP3	180		MI-2SPFP4	215	15	49.5	75.5	—	58	Fig. 4
NF250-CP/SP/HP, NF250-SEP/HEP, MB225-SP	NV225-CP/SP/HP, NV225-SEP/HEP, MN225-SP		38									
NF225-RP/UP	NV225-RP	MI-4SPFP3	224		MI-4SPFP4	270	47.5	53	96	—	74	Fig. 4
NF400-CP/SP/SEP/HEP/REP	NV400-CP/SP/SEP/HEP/REP											
NF400-UEP(3P)	—	MI-4UPFP3	—	246	—	—	47.5	53	76	—	74	
NF630-CP/SP/SEP/HEP/REP, NF800-CEP/SDP/SEP/HEP/REP	NV630-CP/SP/SEP/HEP, NV800-SEP/HEP	MI-6SPFP3	300		MI-6SPFP4	370	47.5	53	96	—	74	
NF400-UEP(4P), NF630-UEP, NF800-UEP	—	MI-6UPFP3	—	314	MI-6UPFP4	383	47.5	53	72.5	—	74	

*1. Specify the breaker mounting pitch (P)

ACCESSORIES

EXTERNAL

● Handle Lock Devices, Extension Handles and Card Holders

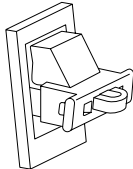
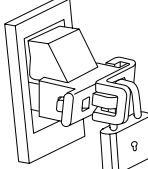
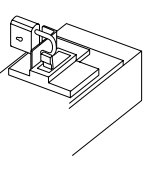
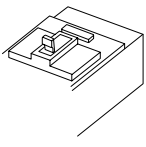
Product		Lock cover (LC)	Handle lock (HL)	Handle lock (HL-S)	Card holder
Breaker type					
NF30-SP, NF50-CP/HP, NF60-CP/HP	2P	LC-05SP	HL-05SP	HLS-05SP2P	CH-P No.5
NF30-SP, NF50-CP/HP, NF60-CP/HP, NV30-SP, NV50-CP/HP, NV60-CP/HP, MB30-SP, MB50-CP/SP, MN50-CP/SP	3P 4P			HLS-05SP	
NF100-CP/SP	2P	LC-1SP	HL-1SP	HLS-1SP2P	
NF100-CP/SP, NF100-SEP/HEP, MB100-SP, NV100-CP/SP/HP, NV100-SEP/HEP, MN100-SP	3P 4P			HLS-1SP	
NF50-HRP, NF100-HP/HP/UP, NV100-HP	2P 3P 4P			HLS-2SP	
NF160-SP/HP, NF250-CP/SP/HP, NF250-SEP/HEP, NV225-CP/SP/HP, NV225-SEP/HEP, MB225-SP, MN225-SP, NF225-RP/UP, NV225-RP	2P 3P 4P				

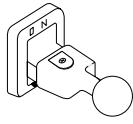
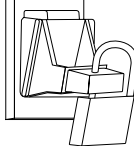
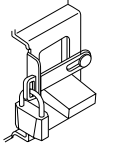
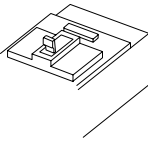
Product	Handle (HT)	Handle lock (HL)	Handle lock (HL-S)	Card holder
Breaker type				
NF400-CP, NV400-CP	HT-4CP	HL-4CP	HLS-4SP	CH-P No.3
NF400-SP/SEP/HEP/REP/UEP, NV400-SP/SEP/HEP/REP			HLS-4UP	
NF400-UEP (3P)	HT-4SP	HL-4SP	HLS-6SP	
NF400-UEP (4P)				
NF630-CP/SP/SEP/HEP/REP/UEP, NV630-CP/SP/SEP/HEP, NF800-CEP/SDP/SEP/HEP/REP/UEP, NV800-SEP/HEP				

Remarks:

1. Padlocks for HL and HL-S must be provided by the customer.
2. Can be mounted regardless of number of poles.
3. HL and HL-S are isolation models.
4. The HL without padlock can be used as a lock cover (LC).

● IEC 35mm Rail Mounting Adapters

Breaker type	Number of poles	Parts number
NF30-SP, NF50-CP/HP, NF60-CP/HP	2P	DIN-05SP2
	3P	DIN-05SP3
NV30-SP, NV50-CP/HP, NV60-CP/HP, MB30-SP, MB50-CP/SP, MN50-CP/SP	3P	
NF100-CP/SP	2P	DIN-1SP2
	3P	DIN-1SP3
NF50-HRP, NF100-HP, NF100-SEP/HEP, NV100-CP/SP/HP, NV100-SEP/HEP, MB100-SP, MN100-SP	2P 3P	

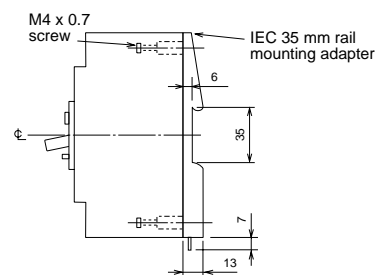

F-Type Operating Handle

● Appearance (color: N1.5)

- Includes as standard a safety device which prevents breaker closing as long as the cover is open. (Specify if this safety feature is not required.)
- Indicates the tripping of the breaker even in ON-lock position—but only in cases when a single padlock (35mm) is used.
- Degrees of protection (in accordance with IEC529): IP3X (IP5X with provision of dustproof packing).



External dimensions

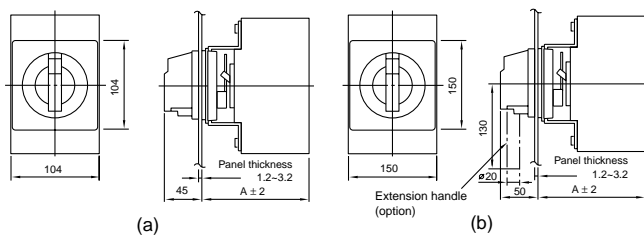

Drilling plan

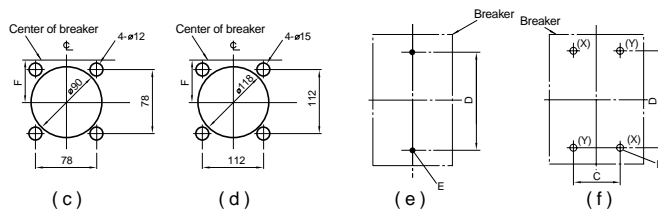

Type	Center of hinge and breaker			
	Left hinge		Right hinge	
	H	X1	H	X2
F05SP2P~F2UP	0 or more	(5H + 100) or more	Less than 10	170 or more
F4SP~F6UP	0 or more	(8H + 150) or more	10 or more	(5H + 120) or more
			0 or more	(4H + 70) or more

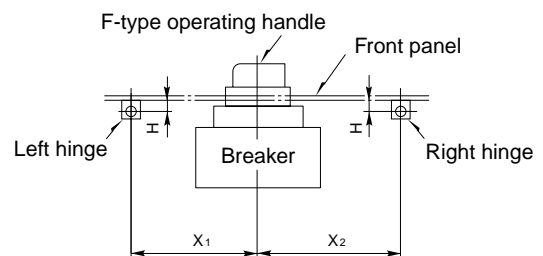

The figure above shows the relationship between the hinge and breaker viewed from the load side of the breaker.

Type	Breaker type	Number of poles	Fig		Dimensions (mm)					Mounting screws		
			External dimensions	Drilling plan	*5 A	C	D	E	F			
F05SP2P	NF30-SP, NF50-CP/HP, NF60-CP/HP	2P	a	c	e	—	111	M4 x 0.7 screw or ø5	—	(X) Breaker mounting screws (2pcs)		
F05SP	NF30-SP, NF50-CP/HP, NF60-CP/HP, NV30-SP, NV50-CP/HP, NV60-CP/HP, MB30-SP, MB50-CP/SP, MN50-CP/SP	3P, 4P			f	25						
F1SP2P	NF100-CP/SP	2P			e	105	132					
F1SP	NF100-CP/SP, NF100-SEP/HEP, NV100-CP/SP/HP, NV100-SEP/HEP, MB100-SP, MN100-SP	3P, 4P			f	30	193				30.5	
F1UP	NF100-RP/UP, NV100-RP	2P, 3P, 4P				105	30				193	—
F2SP	NF160-SP/HP, NF250-CP/SP/HP, NF250-SEP/HEP, NV225-CP/SP/HP, NV225-SEP/HEP, MB225-SP, MN225-SP	2P, 3P, 4P				107	35				126	—
F2UP	NF225-RP/UP, NV225-RP	2P, 3P, 4P			107	35	201				37.5	
F4SP	NF400-CP/SP/SEP/HEP/REP	2P, 3P, 4P	b	d	f	183	44	194	—	(X) (Y) Breaker mounting screws (4 pcs)		
F4SPNV	NV400-CP/SP/SEP/HEP/REP	3P, 4P				280	44	234	20			
F4UP	NF400-UEP	3P				183	70	243	—			
F6SP	NF630-CP/SP/SEP/HEP/REP, NF800-CEP/SDP/SEP/HEP/REP	2P, 3P, 4P				280	70	290	23.5			
F6SPNV	NV630-CP/SP/SEP/HEP, NV800-SEP/HEP	3P, 4P										
F6UP	NF400-UEP (3P), NF630-UEP, NF800-UEP	3P, 4P										

*1. Handles with NV in the product name include a test button.
 *2. Dustproof packing is also available as an option.
 *3. Other optional handles can also be mounted.
 *4. F4SP~F6UP are for isolation purposes.
 *5. The figures show the dimensions of the front connection. Some connection and plug-in breakers have a different reference surface for mounting purposes.

ACCESSORIES

EXTERNAL

S-Type Operating Handle

● Appearance (color: N1.5)

- Indicates the tripping of the breaker even in ON-lock position--but only in cases when a single padlock (35mm) is used.
- Degrees of protection (in accordance with IEC529): IP5X.

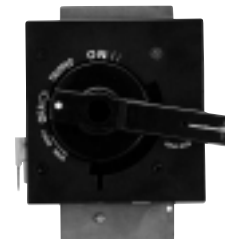

External dimensions

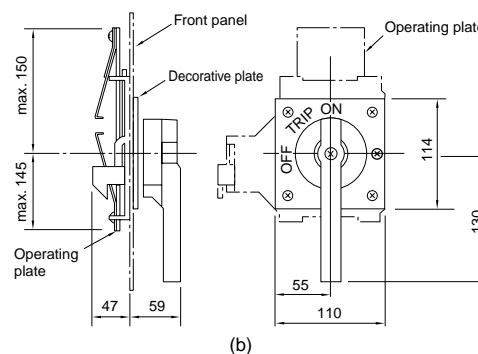
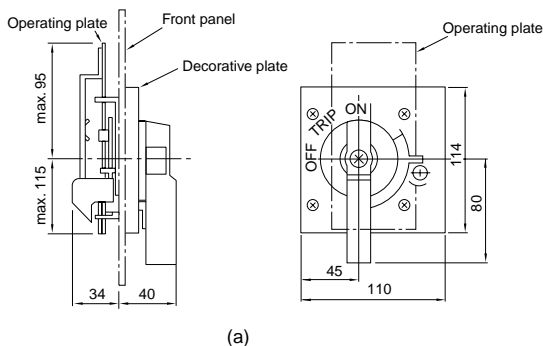

Drilling plan

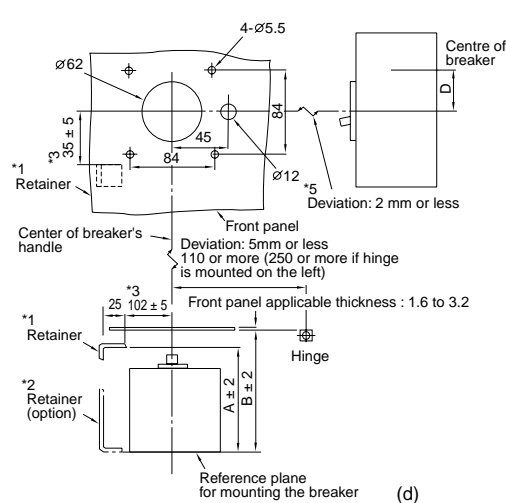
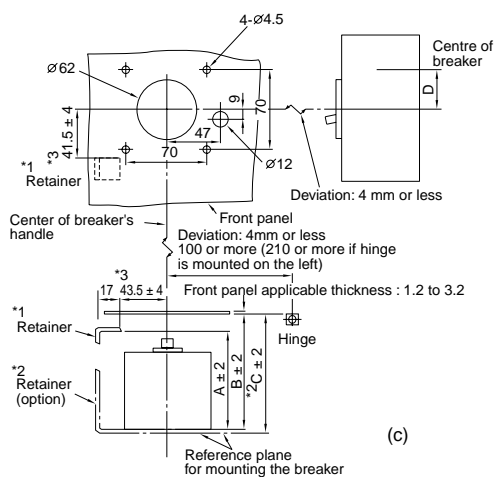

Type	Breaker type	Fig		Dimensions (mm)			
		External dimensions	Drilling plan	A*4	B*4	C*4	D
S05SP	NF30-SP, NF50-CP/HP, NF60-CP/HP, NV30-SP, NV50-CP/HP NV60-CP/HP, MB30-SP, MB50-CP/SP, MN50-CP/SP	a	c	87	102	104.5	0
S1SP	NF50-HRP, NF100-CP/SP/HP, NF100-SEP/HEP, NV100-CP/SP/HP NV100-SEP/HEP, MB100-SP, MN100-SP	a	c	87	102	104.5	0
	30.5						
S2SP	NF160-SP/HP NF250-CP/SP/HP, NF250-SEP/HEP, NV225-CP/SP/HP NV225-SEP/HEP, MB225-SP, MN225-SP	a	c	95	110	112.5	0
	37.5						
S4CP	NF400-CP, NV400-CP	b	d	140	156	—	0
S4SP	NF400-SP/SEP/HEP/REP, NV400-SP/SEP/HEP/REP NF630-CP/SP/SEP/HEP/REP, NV630-CP/SP/SEP/HEP NF800-CEP/SDP/SEP/HEP/REP, NV800-SEP/HEP	b	d	162	178	—	0
	NF400-UEP (3P)			259	275	—	20
	NF400-UEP (4P), NF630-UEP, NF800-UEP			259	275	—	23.5

*1. Retainers are not included. They must be provided by the customer.

*2. When using optional retainer.

*3. Shows the tolerance for the distance from the center of a 62mm dia. hole.

*4. The figures show the front-connection dimensions. Some rear-connection and plug-in breakers have a different reference surface for mounting purposes.

*5. The tolerance is less than 5mm. It does not conform to isolation purposes, however, if the deviation is more than 2mm.

SS-Type Operating Handle

- **Appearance (color: N1.5)**
- Contact your dealer for external dimensions and drilling plan.



Type	Breaker type
SS05SP	NF30-SP, NF50-CP/HP, NF60-CP/HP, NV30-SP, NV50-CP/HP, NV60-CP/HP, MB30-SP, MB50-CP/SP, MN50-CP/SP
SS1SP	NF50-HRP, NF100-CP/SP/HP, NF100-SEP/HEP, NF100-RP/UP, NV100-CP/SP/HP, NV100-SEP/HEP, NV100-RP, MB100-SP, MN100-SP
SS2SP	NF160-SP/HP, NF250-CP/SP/HEP, NF250-SEP/HEP, NF225-RP/UP, NV225-CP/SP/HP, NV225-SEP/HEP, NV225-RP, MB225-SP, MN225-SP
SS4CP	NF400-CP, NV400-CP
SS4SP	NF400-SP/SEP/HEP/REP, NV400-SP/SEP/HEP/REP, NF630-CP/SP/SEP/HEP/REP, NV630-CP/SP/SEP/HEP, NF800-CEP/SDP/SEP/HEP/REP, NV800-SEP/HEP
	NF400-UEP (3P)
	NF400-UEP (4P), NF630-UEP, NF800-UEP

ACCESSORIES

EXTERNAL

V-Type Operating Handle

Appearance

- Can be locked in OFF position only.
- The door is locked when ON and can only be opened in OFF position.
- Degrees of protection (in accordance with IEC529): IP54.

Outview

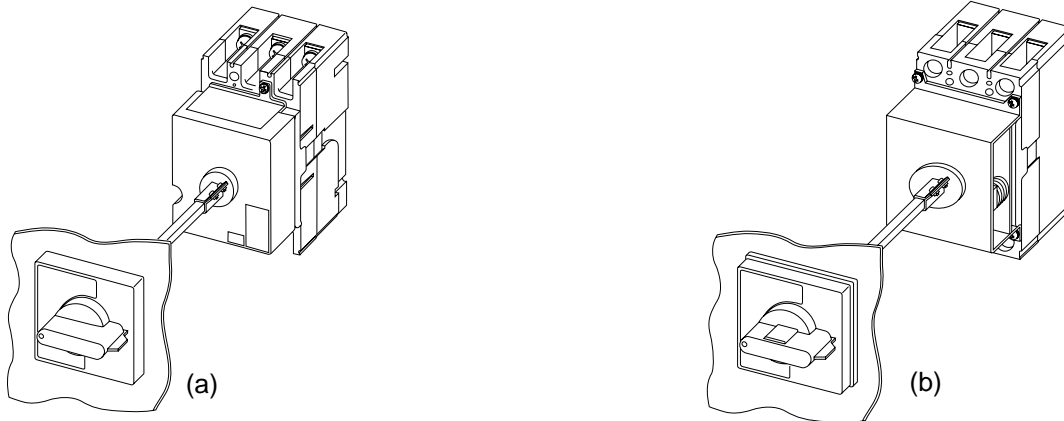

External dimensions

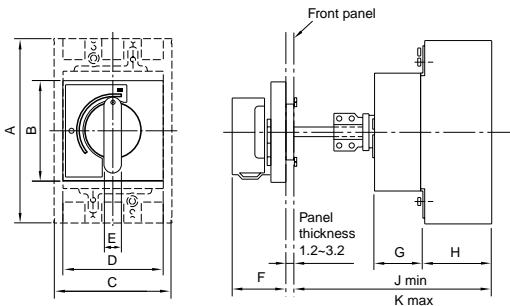

Drilling plan

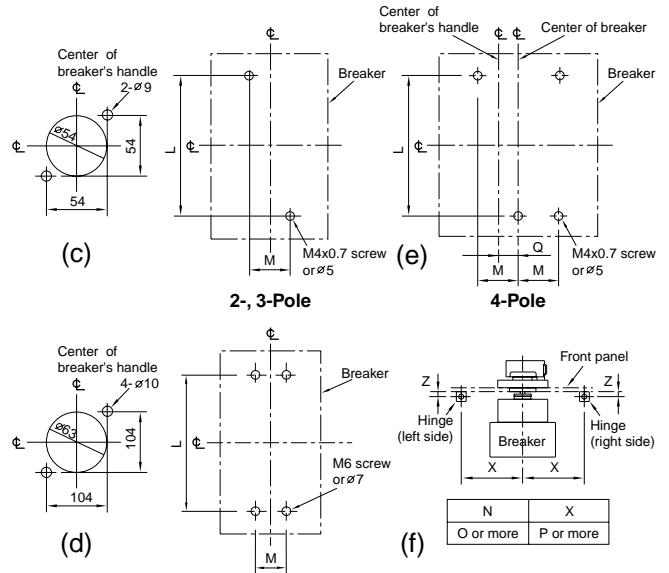

Type	Breakers type		Fig.		Dimensions (mm)													
	MCCB	ELCB	Outview	Drilling plan	A	B	C	D	E	F	G	H	J	K	L	M	P	Q
V1SP	NF50-HRP, NF100-CP, NF100-CP T/A, NF100-SP, NF100-SP T/A, NF100-HP, NF100-HP T/A, NF100-SEP, NF100-HEP	NV100-CP, NV100-SP, NV100-HP, NV100-SEP, NV100-HEP	a	c, e	155	90	90	90	16	49	41	61	154	518	132	30	5N+100	15
V2SP	NF160-SP, NF160-SP T/A, NF160-HP, NF160-HP T/A, NF250-CP, NF250-CP T/A, NF250-SP, NF250-SP T/A, NF250-HP, NF250-HP T/A, NF250-SEP, NF250-HEP	NV225-CP, NV225-SP, NV225-SEP, NV225-HP, NV225-HEP			165	90	105	90	16	49	43	61	154	518	126	35	5N+100	17.5
V4SP	NV400-CP, NF400-SP, NF400-SEP, NF400-HEP	—	b	d, f	257	140	140	140	25	62	76	97	217	539	194	44	8N+150	—
V6SP	NF630-CP, NF630-SP, NF630-SEP, NF630-HEP, NF800-CEP, NF800-SDP, NF800-SEP, NF800-HEP	NV630-CP, NV630-SP, NV630-SEP, NV630-HEP, NV800-SEP, NV800-HEP			275	140	210	140	25	62	76	97	217	539	243	70	8N+150	—

R-Type Operating Handle

Appearance

- Can be locked in OFF position only.

Outview

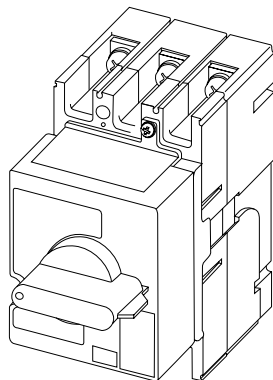

(a)

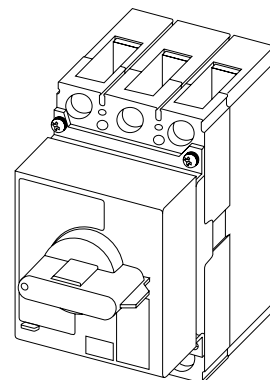

(b)

External dimensions

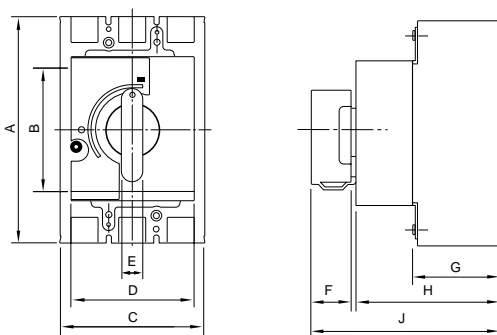

Drilling plan

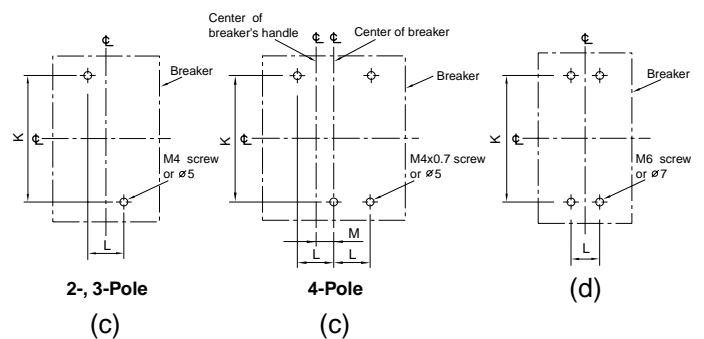

Type	Breaker type		Fig		Dimensions (mm)											
	MCCB	ELCB	Outview	Drilling plan	A	B	C	D	E	F	G	H	J	K	L	M
R1SP	NF50-HRP, NF100-CP, NF100-CP T/A, NF100-SP, NF100-SP T/A, NF100-HP, NF100-HP T/A, NF100-SEP, NF100-HEP	NV100-CP, NV100-SP, NV100-HP, NV100-SEP, NV100-HEP	a	c	155	110	90	89	16	29	61	102	135	132	30	15
R2SP	NF160-SP, NF160-SP T/A, NF160-HP, NF160-HP T/A, NF250-CP, NF250-CP T/A, NF250-SP, NF250-SP T/A, NF250-HP, NF250-HP T/A, NF250-SEP, NF250-HEP	NV225-CP, NV225-SP, NV225-SEP, NV225-HP, NV225-HEP			165	110	105	89	16	29	61	104	137	126	35	17.5
R4SP	NF400-CP, NF400-SP, NF400-SEP, NF400-HEP	—	b	d	257	128	140	140	25	43	97	174	218	194	44	—
R4SPNV	—	NV400-CP, NV400-SP, NV400-SEP, NV400-HEP			275	128	210	140	25	43	97	174	218	243	70	—
R6SP	NF630-CP, NF630-SP, NF630-SEP, NF630-HEP, NF800-CEP, NF800-SDP, NF800-SEP, NF800-HEP	NV630-CP, NV630-SP, NV630-SEP, NV630-HEP, NV800-SEP, NV800-HEP														

ACCESSORIES

EXTERNAL

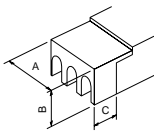
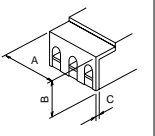
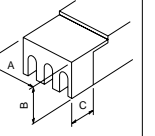
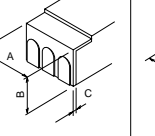
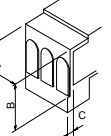

Terminal Cover

Breaker type		Large terminal cover (TC-L)	Small terminal cover (TC-S)	Transparent terminal cover (TTC)	Rear terminal cover (BTC)	Plug-in terminal cover (PTC)
						
NF30-CS	2P	TCL-03CS2 (45X30.5X25)	TCS-03CS2 (45X30.5X5)	TTC-03CS2 (45X30.5X25)	BTC-03CS2 (45X30.5X6.5)	—
NF30-CS, NV30-CS, MN30-CS	3P	TCL-03CS3 (67X30.5X25)	TCS-03CS3 (67X30.5X5)	TTC-03CS3 (67X30.5X25)	BTC-03CS3 (67X30.5X6.5)	—
NF30-SP, NF50-CP/HP, NF60-CP/HP	2P	TCL-05SP2 *1 (50X64X 25)	TCS-05SP2 (50X64X5)	TTC-05SP2 *1 (50X64X25)	BTC-05SP2 (50X64X6.5)	PTC-05SP2 (50X64X6.5)
NF30-SP, NF50-CP/HP, NF60-CP/HP NV30-SP, NV50-CP/HP, NV60-CP/HP MB30-SP, MB50-CP/SP, MN50-CP/SP	3P	TCL-05SP3 *2 (75X65.5X 25)	TCS-05SP3 (75X64X 5)	TTC-05SP3 *2 (75X65.5X 25)	BTC-05SP3 (75X64X 6.5)	PTC-05SP3 (75X64X 6.5)
NF50-HP NF60-HP	4P	TCL-05SP4 (100X65.5X25)	—	—	—	—
NF100-CP/SP	2P	TCL-1SP2 *1 (60X65.5X 40)	TCS-1SP2 (60X65.5X 6.5)	TTC-1SP2 *1 (60X65.5X 40)	BTC-1SP2 (60X65.5X 6.5)	PTC-1SP2 (60X65.5X 6.5)
NF100-CP/SP, NF100-SEP/HEP, NV100-CP/SP/HP NV100-SEP/HEP, MB100-SP, MN100-SP, NV100-RP	3P	TCL-1SP3 *2 (90X65.5X 40)	TCS-1SP3 (90X65.5X 6.5)	TTC-1SP3 *2 (90X65.5X 40)	BTC-1SP3 (90X65.5X 6.5)	PTC-1SP3 *3 (90X65.5X 6.5)
NF50-HRP, NF100-HP, NF100-RP/UP	2P, 3P					
NF100-SP/HP/UP, NF100-SEP/HEP, NV100-SEP/HEP	4P	TCL-1SP4 *2 (120X65.5X40)	—	—	—	—
NF160-SP/HP NF250-CP/SP, NF250-SEP/HEP, NF225-RP/UP NV225-CP/SP/HP, NV225-SEP/HEP, MB225-SP MN225-SP, NV225-RP	2P 3P	TCL-2SP3 *2 (105X65.5X 40)	TCS-2SP3 (105X65.5X 6.5)	TTC-2SP3 *2 (105X65.5X 40)	BTC-2SP3 (105X65.5X 6.5)	PTC-2SP3 *4 (105X65.5X 6.5)
NF250-SP/HP, NF250-SEP/HEP, NV225-SEP/HEP, NF225-UP	4P					

Remarks: 1. () Shows external dimensions in mm.

2. Terminal covers for 4-pole models can be made to order. (Terminal covers other than the TCL-05SP4 are not solid moldings.)

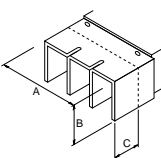
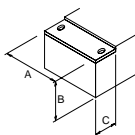
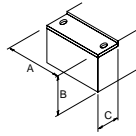
- * 1. To order F-type operating handle, add F to the end of the product number. (The F-type terminal cover uses screws to fasten.)
- * 2. Can be combined as standard with an V.R.F-type operating handle.
- * 3. Except for NF100-RP/UP and NV100-RP.
- * 4. Except for NF225-RP/UP and NV225-RP.

Breaker type		Large terminal cover (TC-L)	Transparent terminal cover (TTC)	Rear terminal cover (BTC)	Plug-in terminal cover (PTC)	
		 Fig.1				
		 Fig.2				
NF400-CP/SP/SEP/HEP/REP NV400-CP/SP/SEP/HEP/REP	2P, 3P	TCL-4SP3 *3 (171X99.5X110)	Fig. 1	TTC-4SP3 (171X104.5X110)	BTC-4SP3 (140X99.5X42)	PTC-4SP3 (140X99.5X42)
NF400-UEP	3P	TCL-4SP3 *1 (171X132.5/196.5X110)		—	BTC-4SP3 *1 (140X132.5/196.5X42)	—
NF400-SP/SEP/HEP, NV400-SEP/HEP	4P	TCL-4SP4 *4 (240X97.5X110)	Fig. 2	TTC-4SP4 (240X104.5X110)	BTC-4SP4 *2 (185X97.5X39)	—
NF630-CP/SP/SEP/HEP/REP, NV630-CP/SP/SEP/HEP NF800-CEP/SDP/SEP/HEP/REP, NV800-SEP/HEP	2P, 3P	TCL-6SP3 *5 (220X97.5X155)		TTC-6SP3 (224X103.5X155)	BTC-6SP3 *2 (210X97.5X32)	—
NF630-UEP, NF800-UEP	3P	TCL-6UP3 *1 (220X146/194.5X155)		—	BTC-6SP3 *1,*2 (210X146/194.5X32)	—
NF630-SP/SEP/HEP, NV630-SEP NF800-SEP/HEP	4P	TCL-6SP4 *6 (290X97.5X155)		TTC-6SP4 (294X103.5X155)	BTC-6SP4 *2 (280X97.5X32)	—
NF400-UEP, NF630-UEP, NF800-UEP	4P	TCL-6UP4 *1 (290X146/194.5X155)		—	BTC-6SP4 *1,*2 (280X146/194.5X32)	—

Remarks: 1. () Shows external dimensions in mm. (AxBxC)

- * 1. Line side/Load side
- * 2. These covers can be mounted on plug-in type.
- * 3. Except for NF400-HEP/REP and NV400-HEP/REP.
- * 4. Except for NF400-HEP and NV400-HEP.
- * 5. Except for NF630-HEP/REP, NV630-HEP, NF800-HEP/REP and NV800-HEP.
- * 6. Except for NF630-HEP and NF800-HEP.

CHARACTERISTICS

MOLDED-CASE CIRCUIT BREAKERS

MCCBs

- NF30-CS, NF30-SP, NF50-CP, NF60-CP, NF50-HP, NF60-HP, MB30-SP, MB50-CP, MB50-SP

● Operating Characteristics

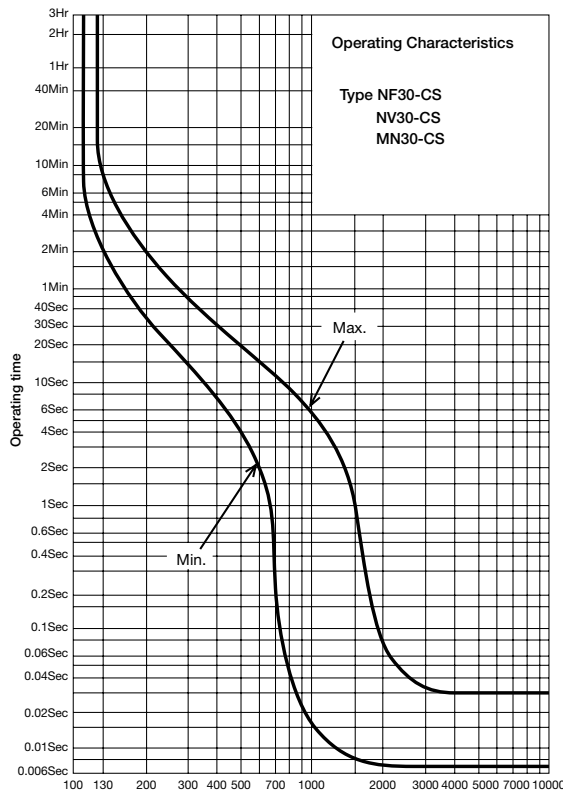
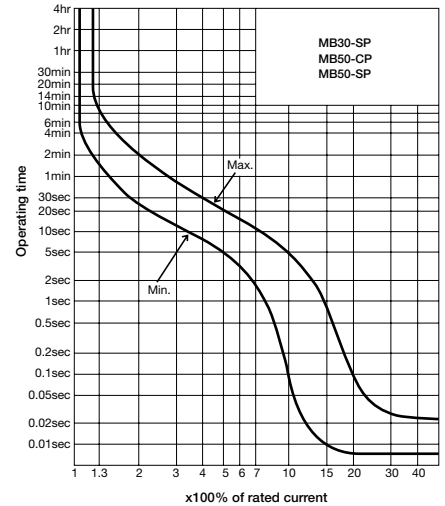
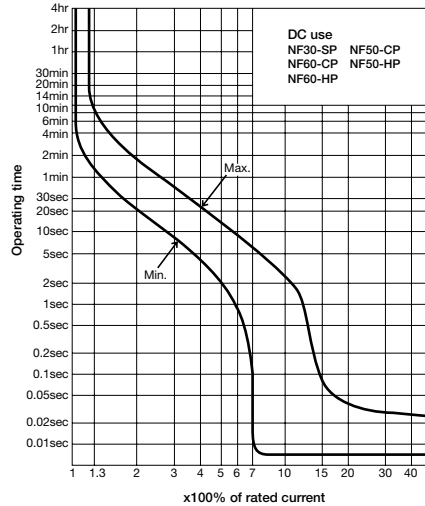
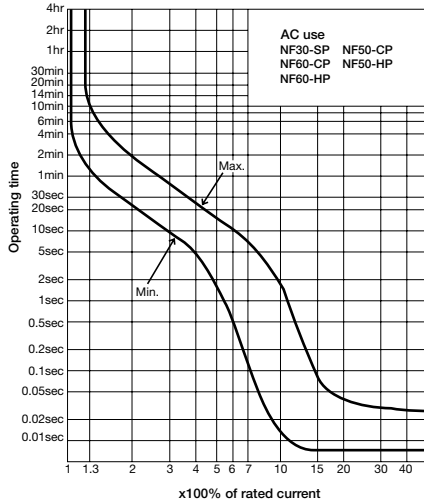

● Temperature Characteristics

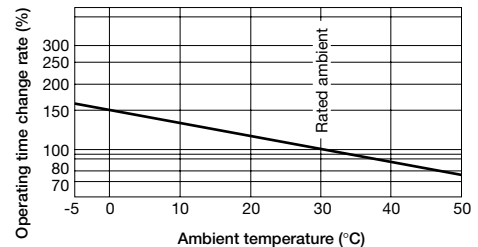

Standard attached parts (Front connection)

Mounting screw M4x0.7x35 (2 and 3P: 2pcs, 4P: 4pcs)
 for NF30-CS M4x0.7x20 2pcs
 Insulation barrier (2P: 1pc, 3P: 2pcs, 4P: 3pcs)
 Only NF50-HP, NF60-HP, MB50-SP

● NF50-HRP, NF100-CP, NF100-SP, NF100-HP, NF100-SEP, NF100-HEP, NF100-RP, NF100-UP, MB100-SP

● Operating Characteristics

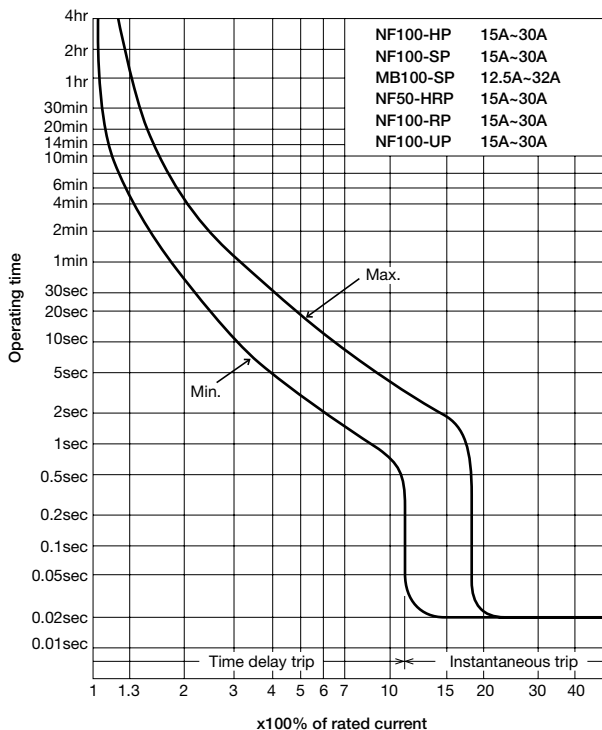

Note: The characteristics for both AC and DC use are the same; however, the products differ from each other.

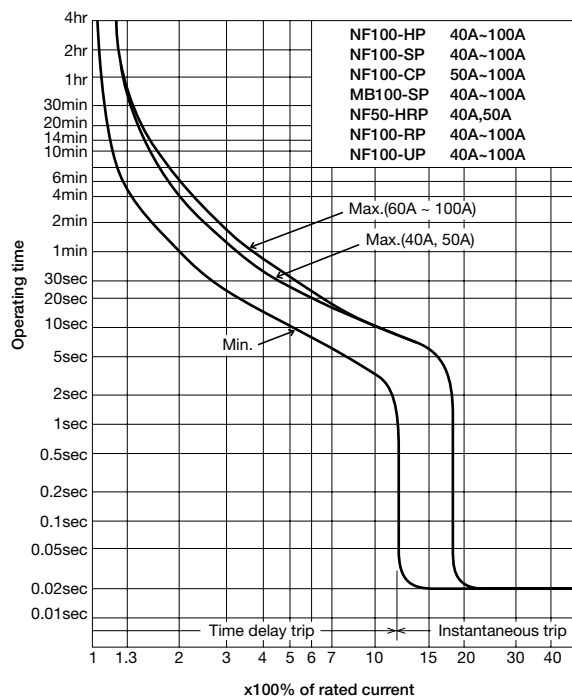

Note: The characteristics for both AC and DC use are the same; however, the products differ from each other.

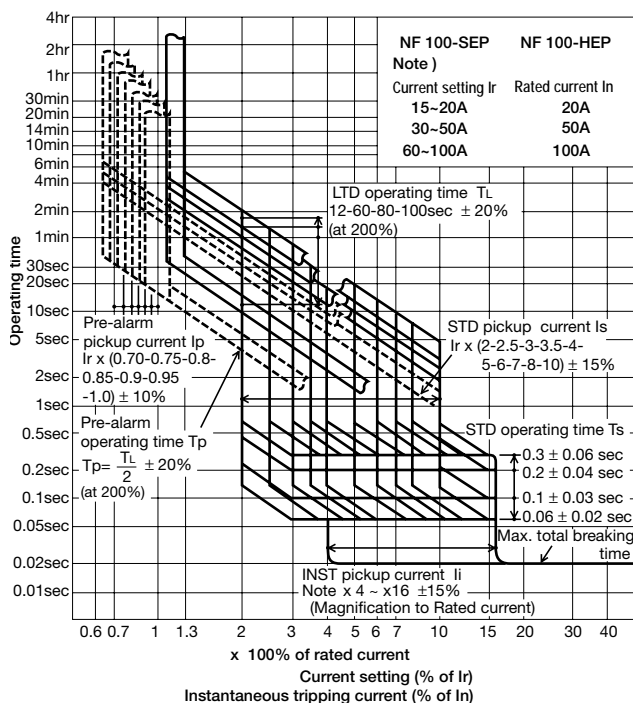

● Temperature Characteristics

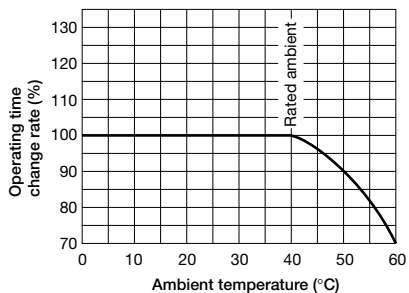
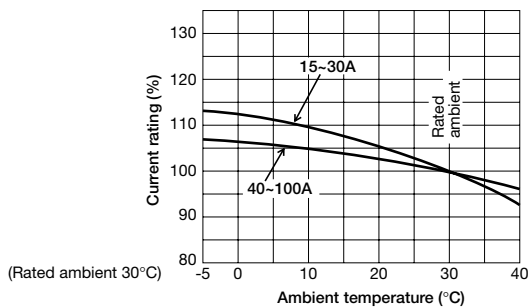

Standard attached parts (Front connection)

Mounting screw M4x0.7x35 (2 and 3P: 2pcs, 4P: 4pcs)
Insulation barrier (2P: 1pc, 3P: 2pcs, 4P: 3pcs)

CHARACTERISTICS

MOLDED-CASE CIRCUIT BREAKERS

MCCBs

● NF100-CP T/A, NF100-SP T/A, NF100-HP T/A

● Operating Characteristics

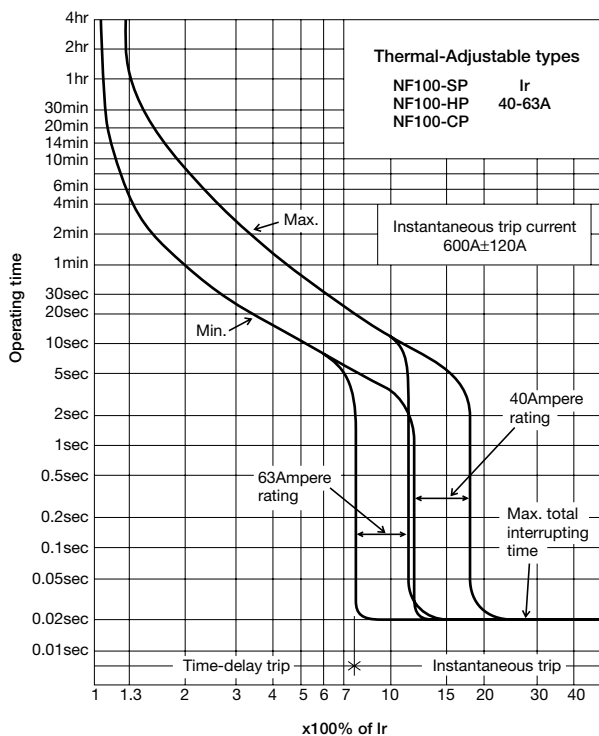
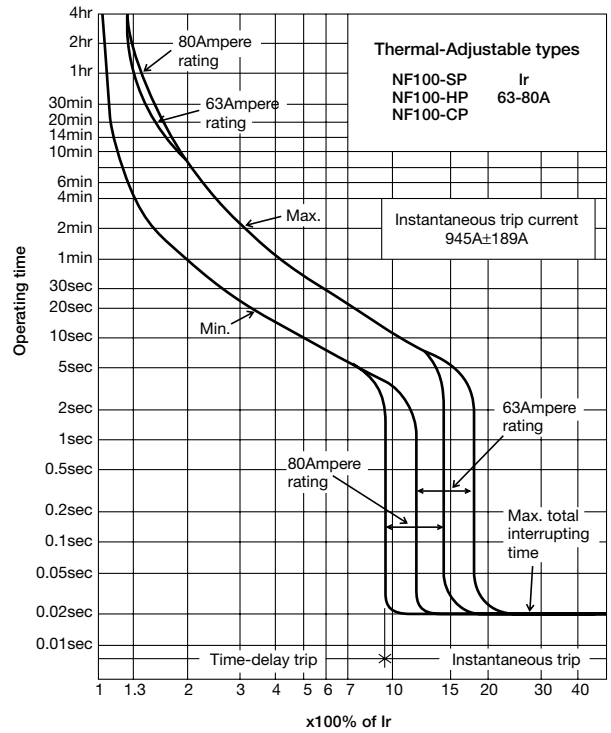
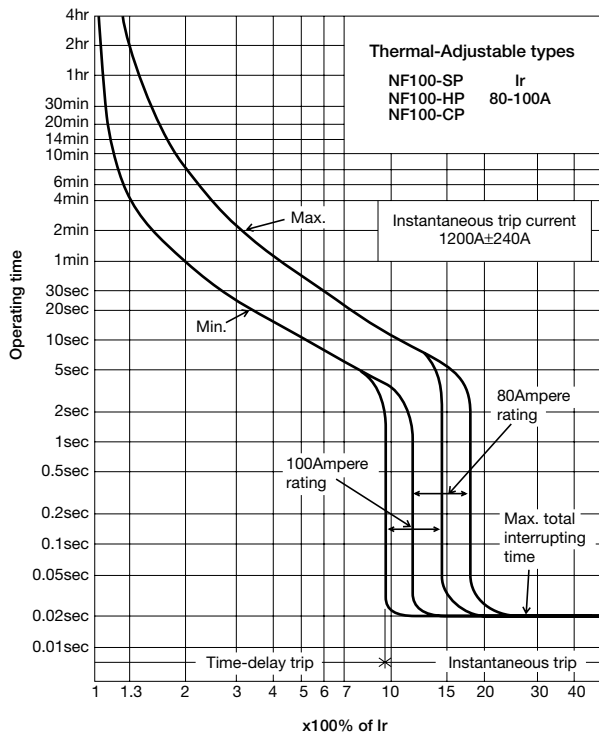

● Temperature Characteristics

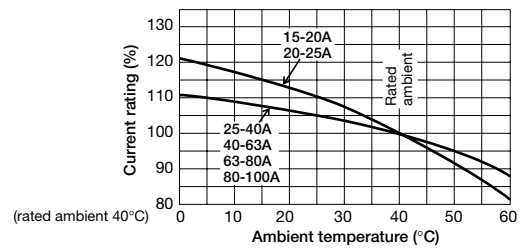

Standard attached parts (Front connection)

Mounting screw M4x0.7x35 (2and3P: 2pcs, 4P: 4pcs)
 Insulation barrier (2P: 1pcs, 3P: 2pcs, 4P: 3pcs)

● **NF100-CP T/A, NF100-SP T/A, NF100-HP T/A**

● **Operating Characteristics**

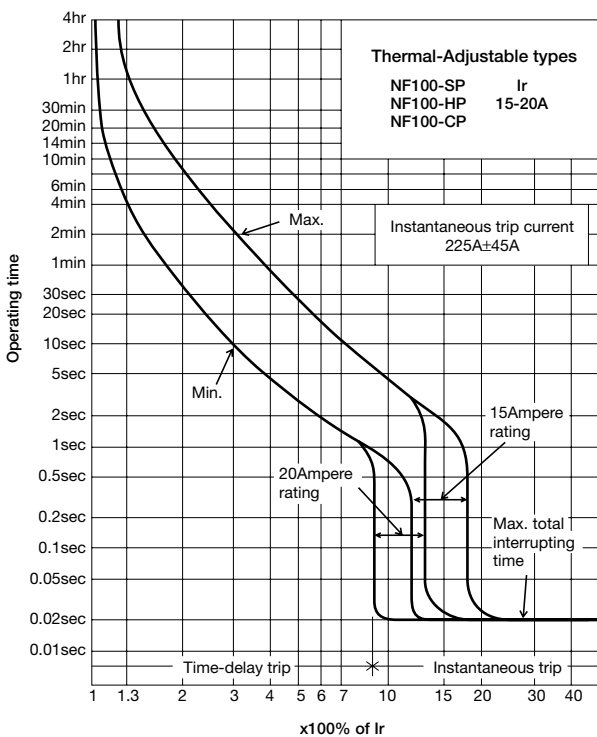
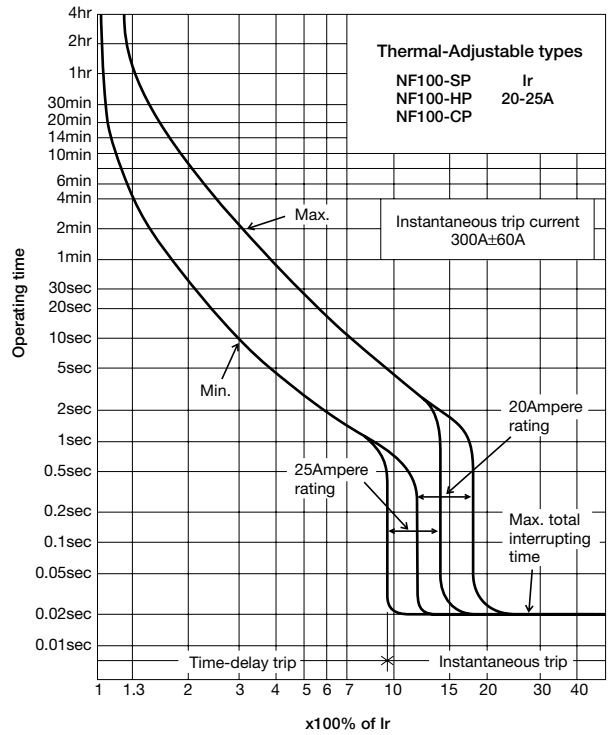
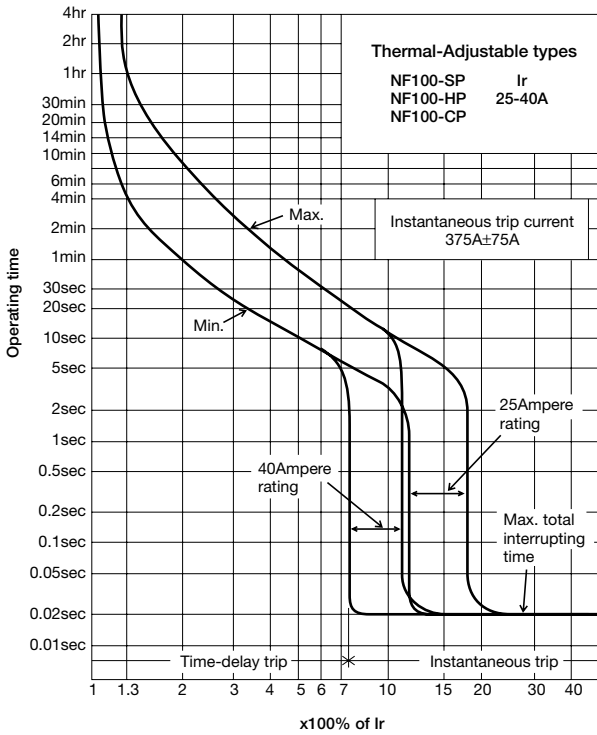

● **Temperature Characteristics**

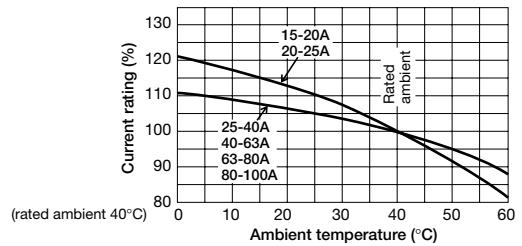

CHARACTERISTICS

MOLDED-CASE CIRCUIT BREAKERS

MCCBs

- NF160-SP, NF160-HP, NF250-CP, NF250-SP, NF250-HP, NF250-SEP, NF250-HEP, NF225-RP, NF225-UP, MB225-SP

Operating Characteristics

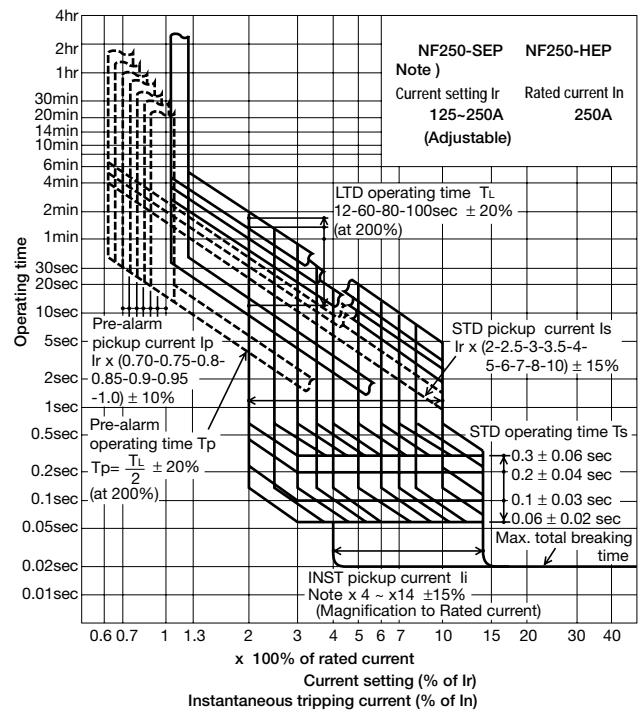
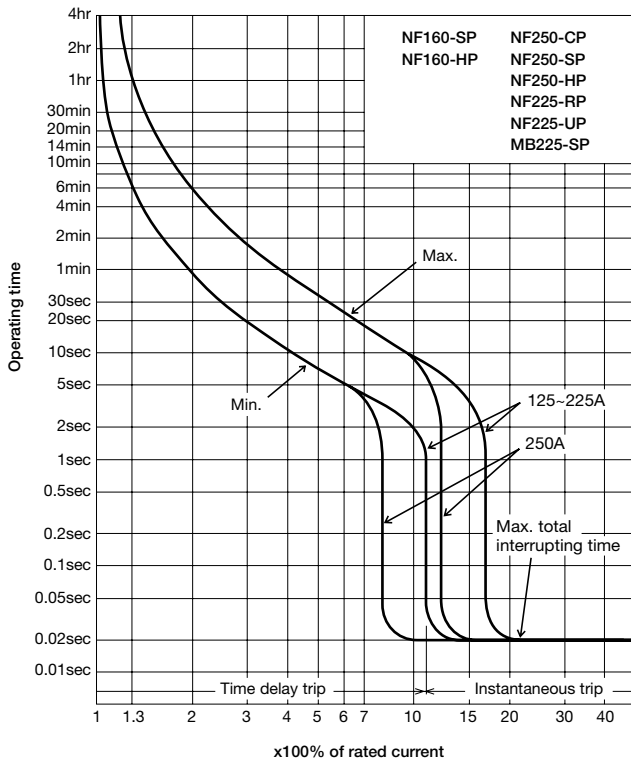

Note: The characteristics for both AC and DC use are the same; however, the products differ from each other.

Temperature Characteristics

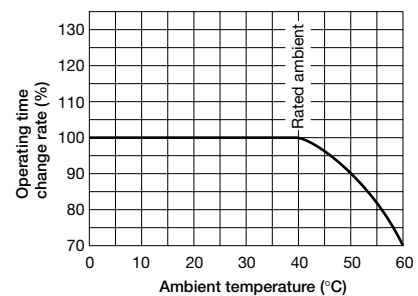
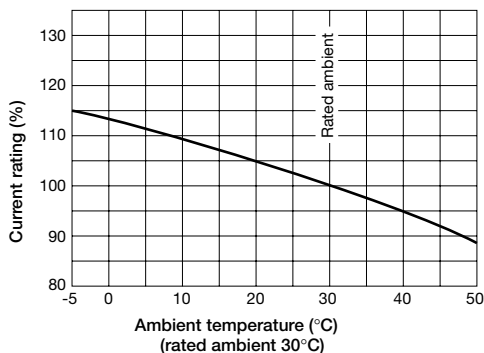

Standard attached parts (Front connection)

Mounting screw M4x0.7x55 (2and3P: 2pcs, 4P: 4pcs)
Insulation barrier (2P: 2pcs, 3P: 4pcs, 4P: 6pcs)

● **NF250-CP T/A, NF250-SP T/A, NF250-HP T/A**

● **Operating Characteristics**

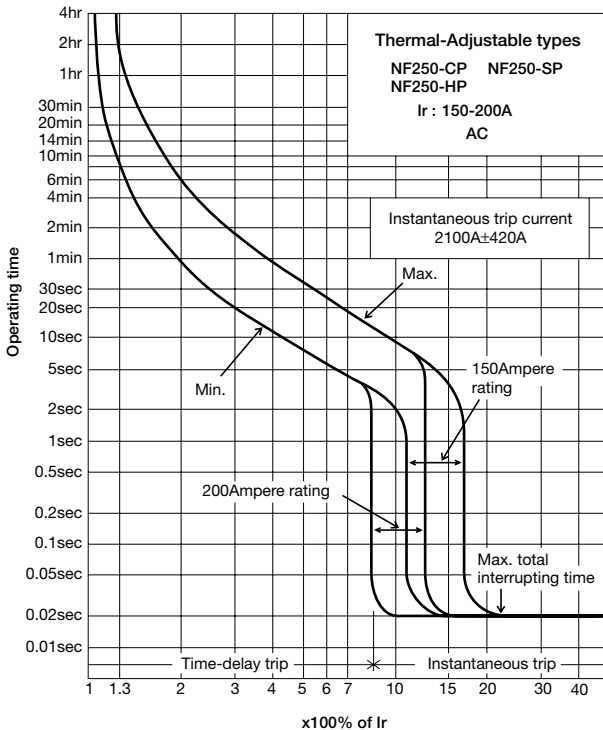
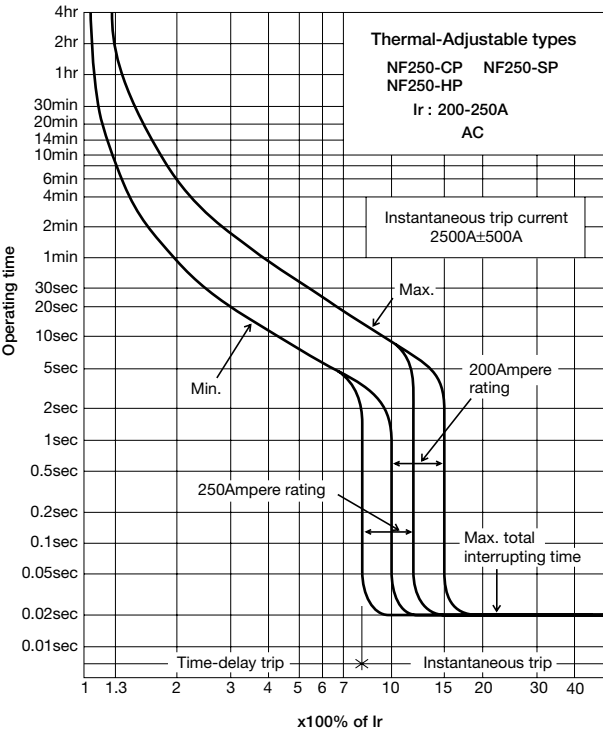

● **Temperature Characteristics**

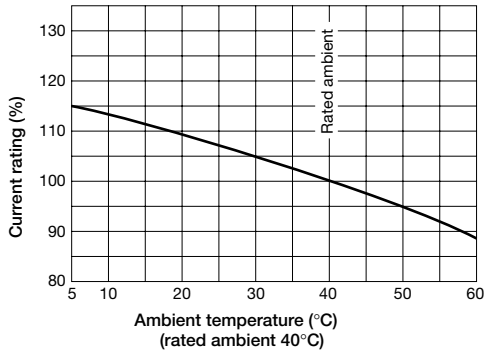

CHARACTERISTICS

MOLDED-CASE CIRCUIT BREAKERS

MCCBs

- NF160-SP T/A, NF160-HP T/A, NF250-CP T/A, NF250-SP T/A, NF250-HP T/A

● Operating Characteristics

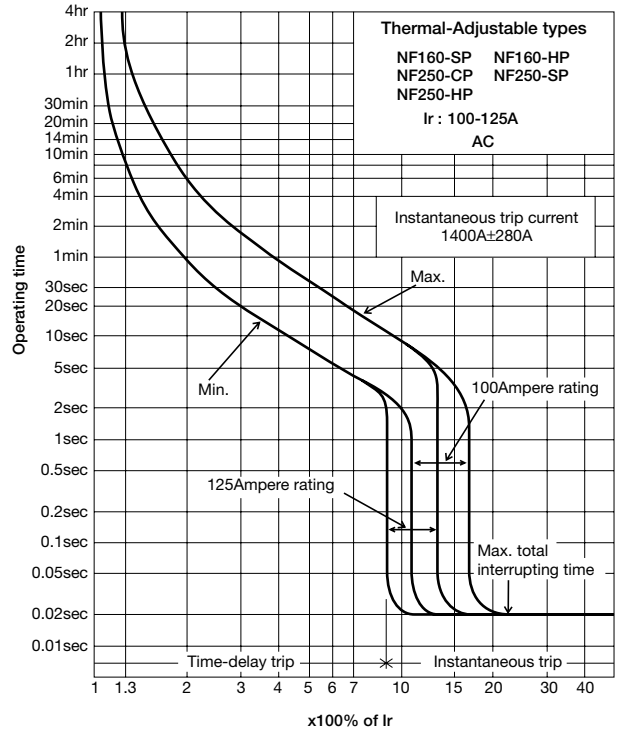
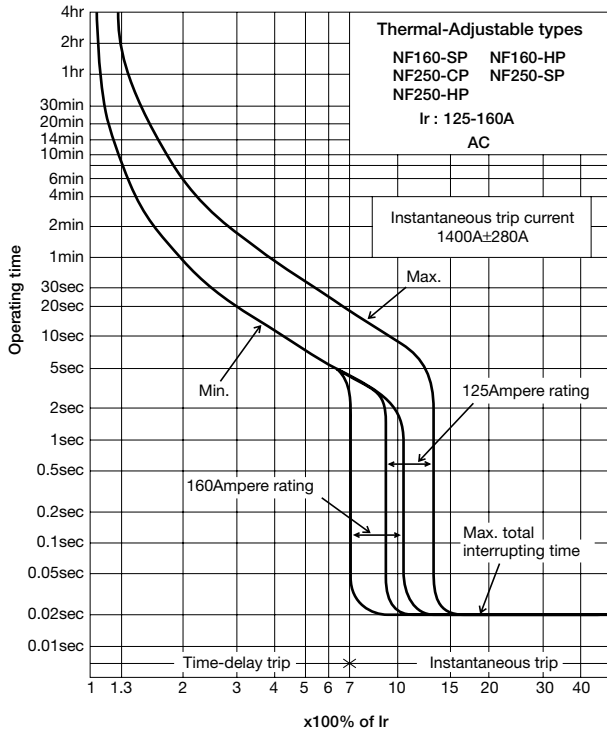

● Temperature Characteristics

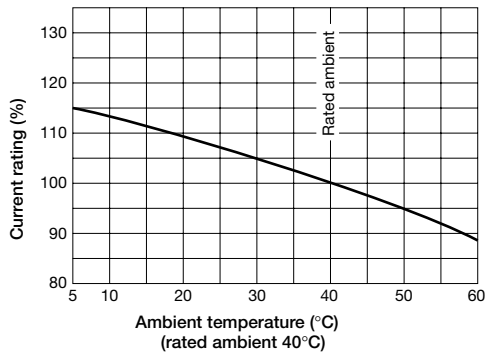

Standard attached parts (Front connection)

Mounting screw M4x0.7x55 (2and3P: 2pcs, 4P: 4pcs)
Insulation barrier (2P: 2pcs, 3P: 4pcs, 4P: 6pcs)

● **NF400-CP, NF400-SP, NF400-SEP, NF400-HEP, NF400-REP**

● **Operating Characteristics**

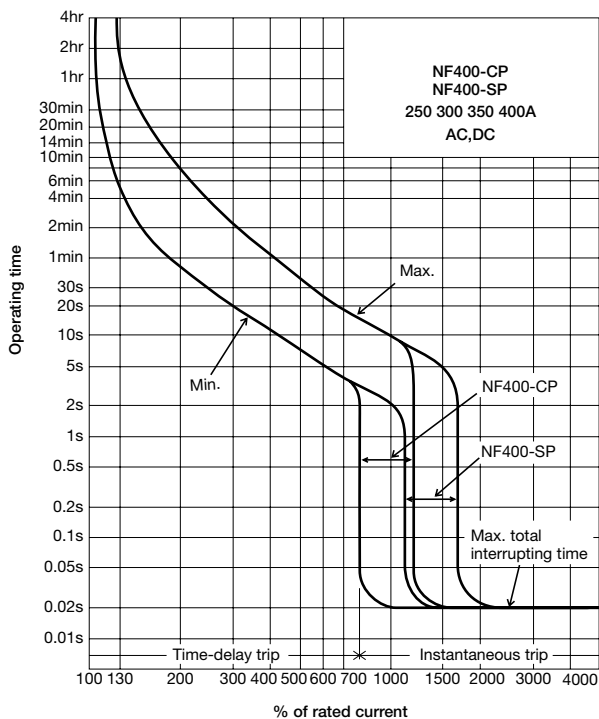

Note: When ordering, please specify if for DC use.

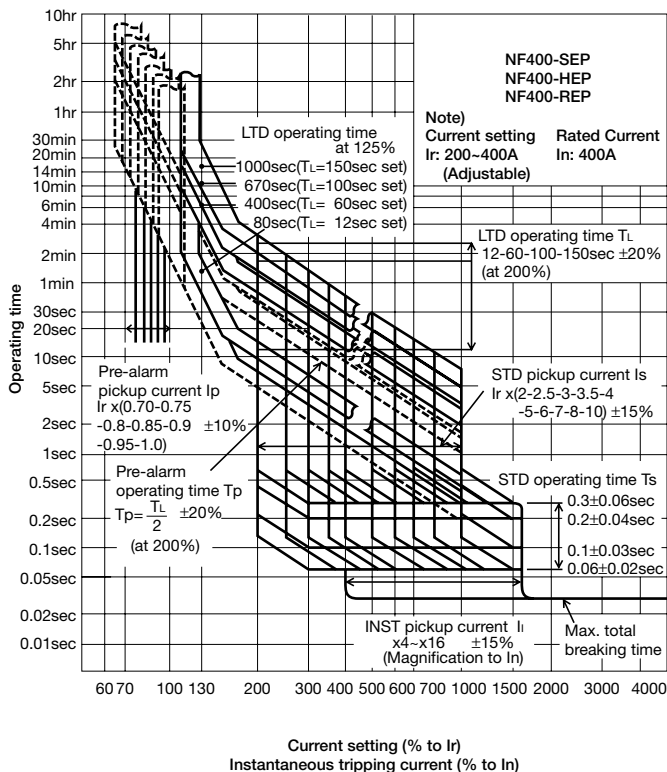

● **Temperature Characteristics**

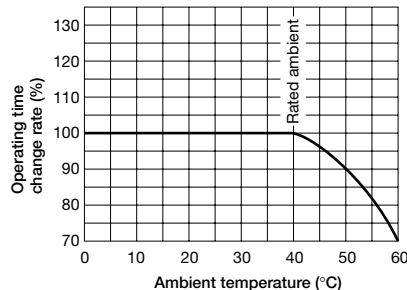
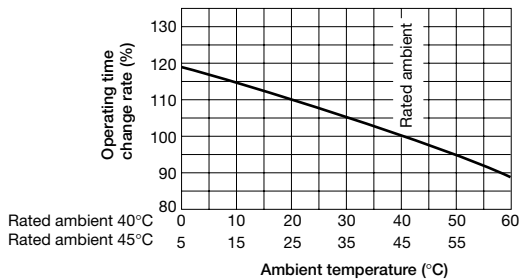

Standard attached parts (Front connection)

- Mounting screw M6x60 (4pcs)
- Insulation barrier (2P: 2pcs, 3P: 4pcs, 4P: 6pcs)

CHARACTERISTICS

MOLDED-CASE CIRCUIT BREAKERS

MCCBs

● NF400-UEP

● Operating Characteristics

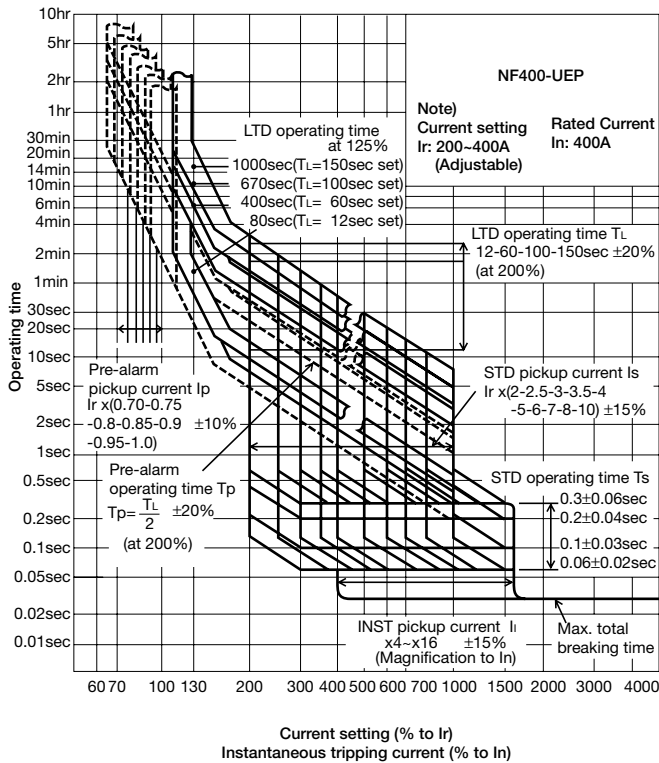

● Temperature Characteristics

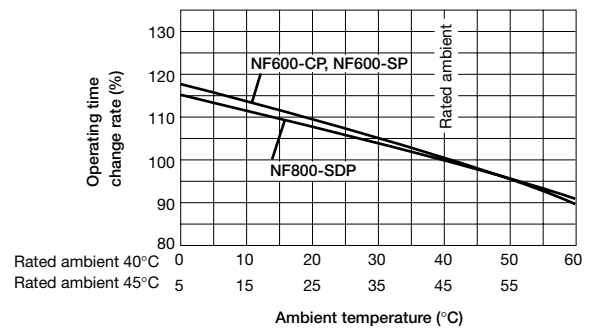

Standard attached parts (Front connection)

Mounting screw M6X65 (2pcs) M6x162 (2pcs)
Insulation barrier (3P: 4pcs)

Standard attached parts (Front connection)

Mounting screw M6X35 (4pcs)
Insulation barrier (2P: 1pcs, 3P: 2pcs, 4P: 3pcs)

● NF630-CP, NF630-SP, NF630-SEP, NF630-HEP, NF630-REP, NF800-CEP, NF800-SDP, NF800-SEP, NF800-HEP, NF800-REP

● Operating Characteristics

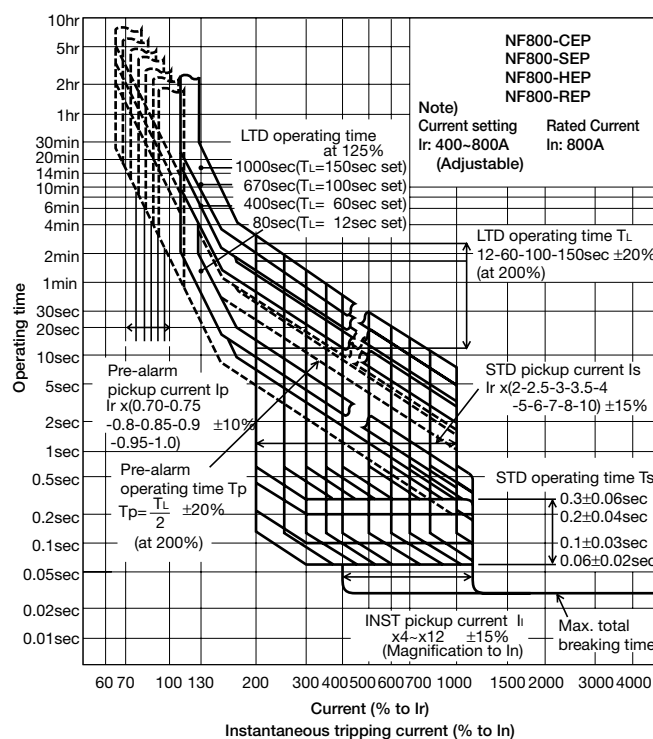
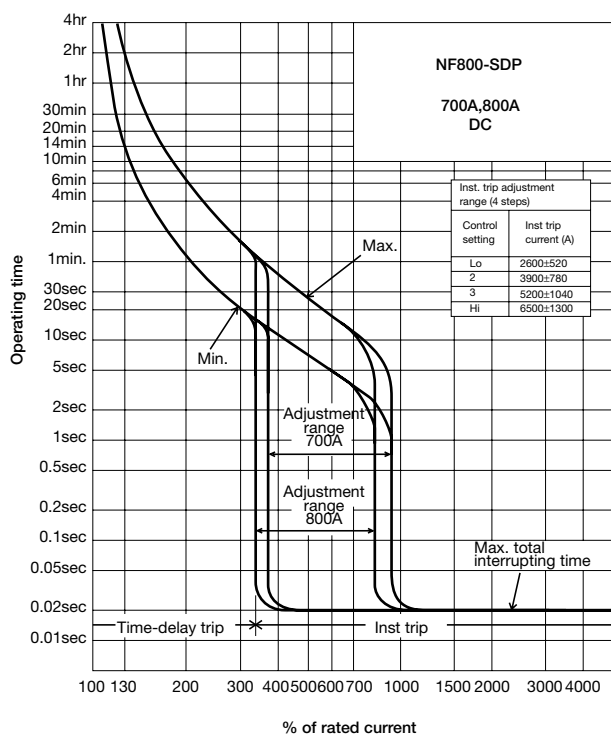
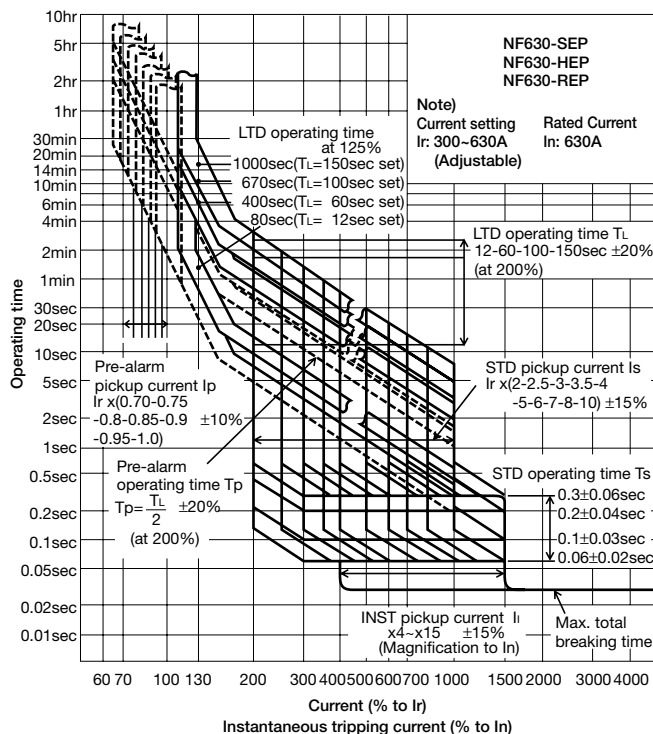
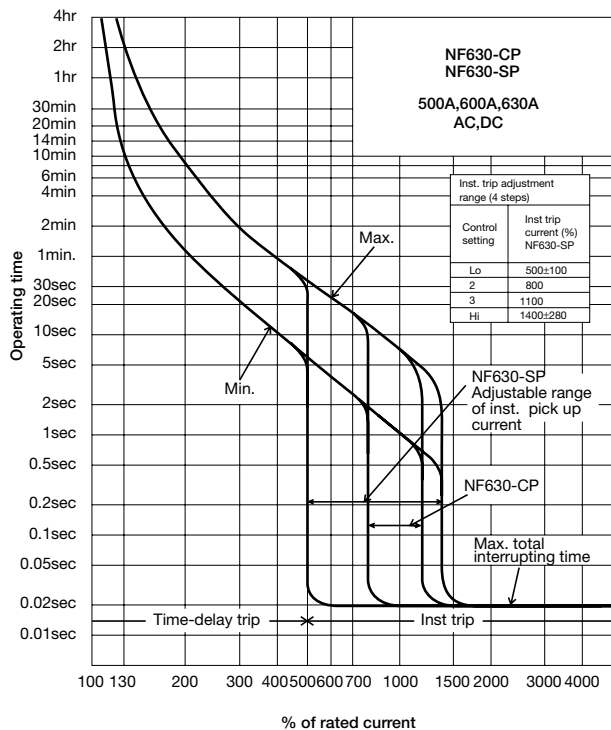

CHARACTERISTICS

MOLDED-CASE CIRCUIT BREAKERS

MCCBs

● NF630-UEP NF800-UEP

● Operating Characteristics

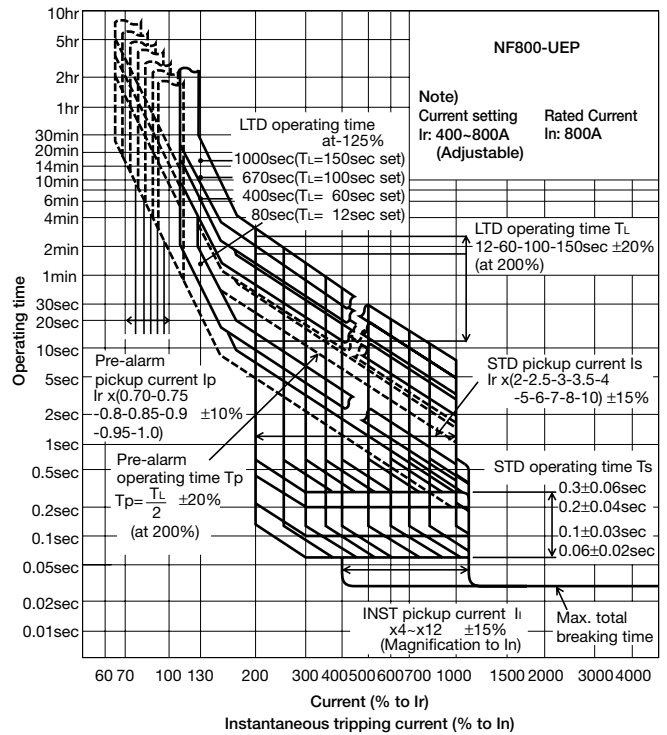
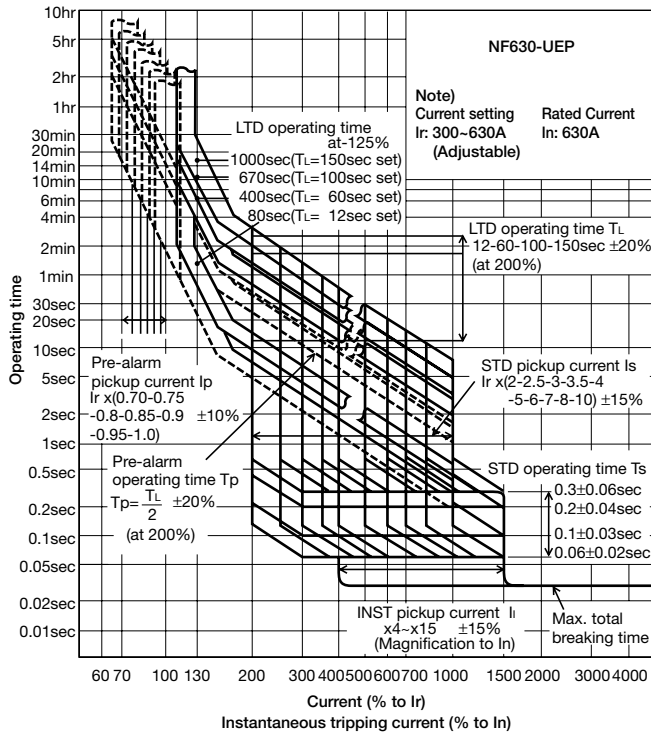

● Temperature Characteristics

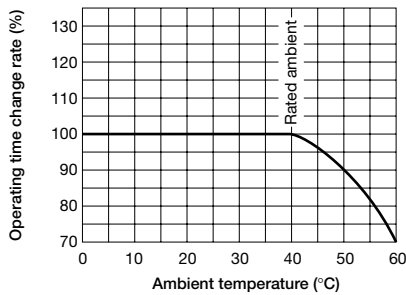

Standard attached parts (Front connection)

Mounting screw 3P: M6X35, M6x132 (2pcs each) 4P: M6x35 (3pcs), M6x132 (2pcs)
Insulation barrier (3P: 2pcs, 4P: 3pcs)

CHARACTERISTICS

EARTH-LEAKAGE CIRCUIT BREAKERS

ELCBs

- NV30-CS, NV30-SP, NV50-CP, NV60-CP, NV50-HP, NV60-HP, MN30-CS, MN50-CP, MN50-SP

• Operating Characteristics

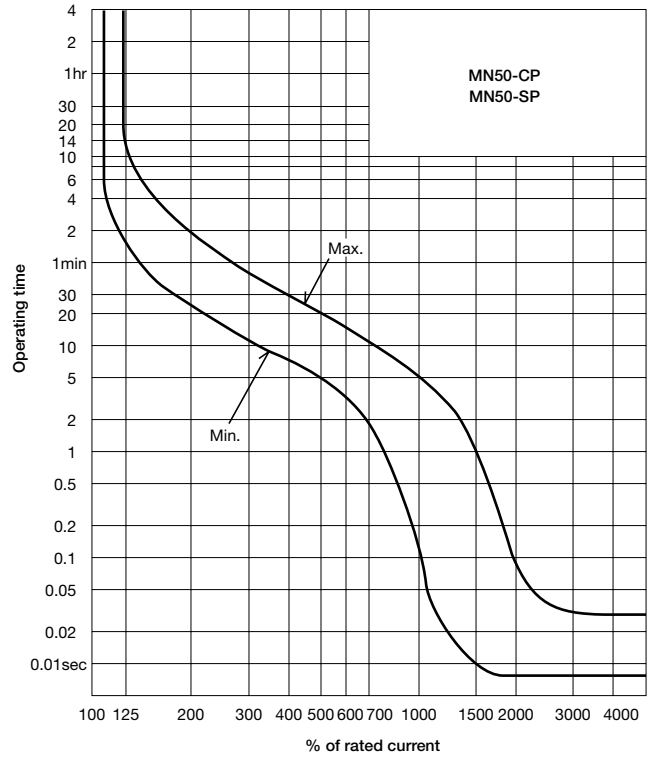
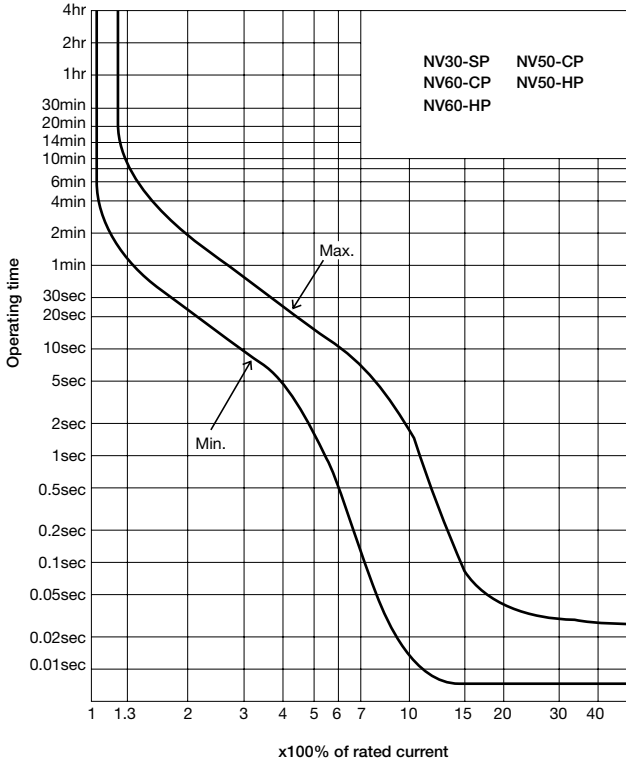

• Earth-Leakage Tripping Characteristics

- NV30-CS/SP, NV30SP, NV50-CP/HP, MN30-CS, NV60-CP/HP, MN50-CP/SP

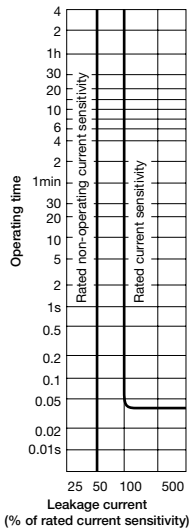

(IEC)

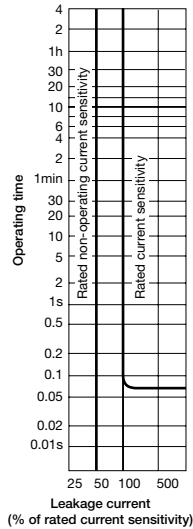

(JIS)

• Temperature Characteristics

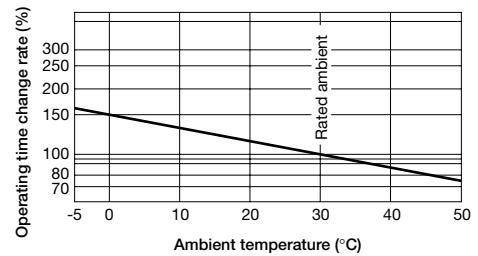

Remark: For NV30-CS and MN30-CS characteristics please refer to Page 68.

CHARACTERISTICS

EARTH-LEAKAGE CIRCUIT BREAKERS

ELCBs

- NV100-CP, NV100-SP, NV100-HP, NV100-SEP, NV100-HEP, NV100-RP, MN100-SP

● Operating Characteristics

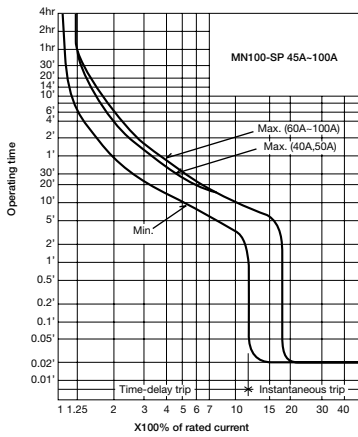
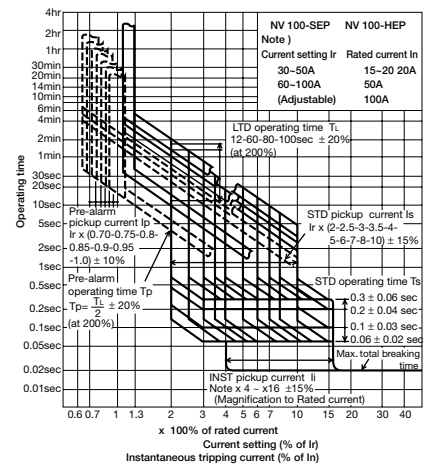
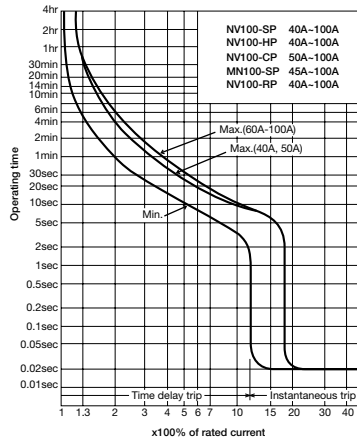
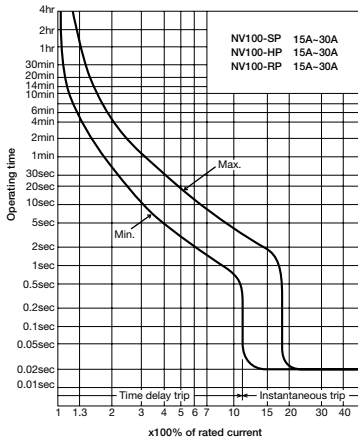

● Temperature Characteristics

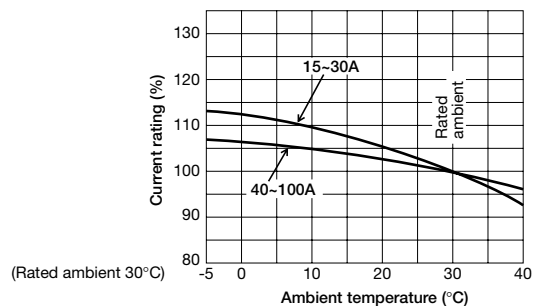
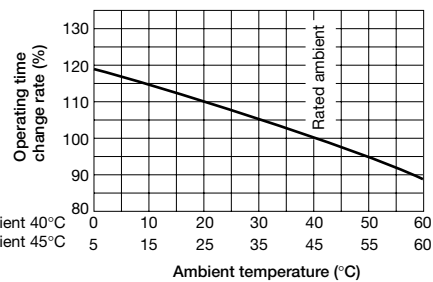

● Earth-Leakage Tripping Characteristics

NV100-CP/SP/HP/RP, NV100-SEP/HEP MN100-SP

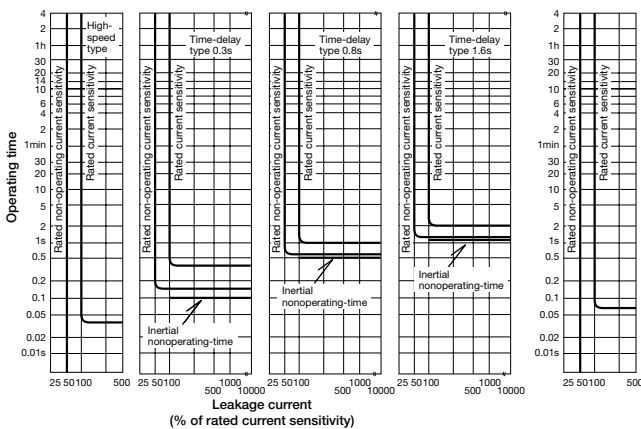

Standard attached parts (Front connection)

Mounting screw M4x0.7x35 (3P: 2pcs, 4P: 4pcs)
Insulation barrier (3P: 2pcs, 4P: 3pcs)

● NV225-CP, NV225-SP, NV225-HP, NV225-RP, NV225-SEP, NV225-HEP, MN225-SP

● Operating Characteristics

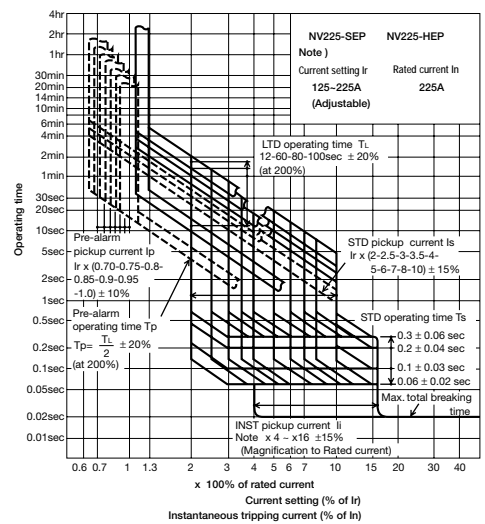
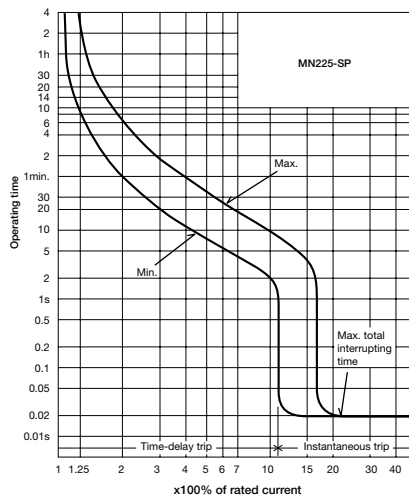
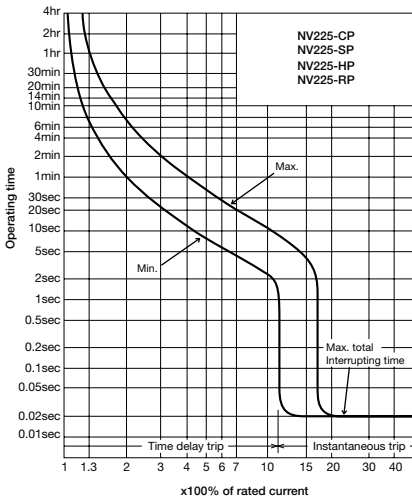

● Earth-Leakage Tripping Characteristics

NV225-CP/SP/HP/RP, NV225-SEP/HEP MN225-SP

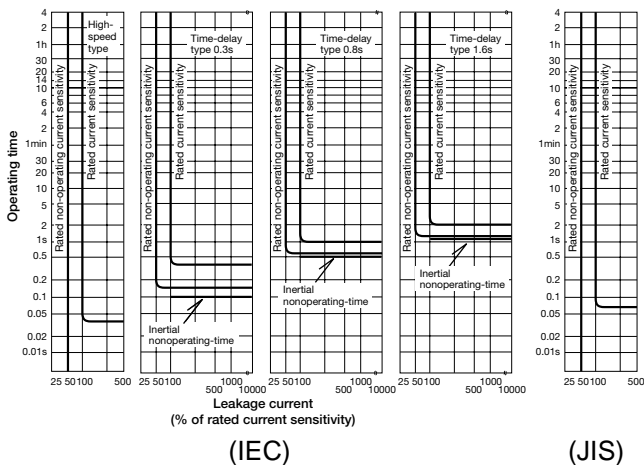

● Temperature Characteristics

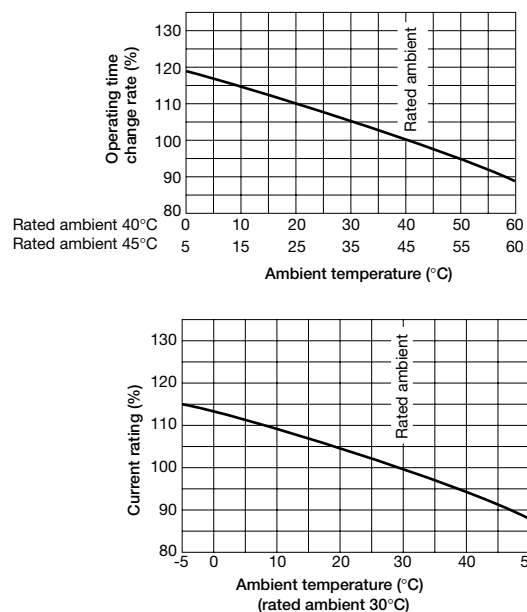

Standard attached parts (Front connection)

Mounting screw M4x0.7x55 (3P: 2pcs, 4P: 4pcs)
Insulation barrier (3P: 4pcs, 4P: 6pcs) *NV225-SEP,HEP 3P:2pcs

CHARACTERISTICS

EARTH-LEAKAGE CIRCUIT BREAKERS

ELCBs

● NV400-CP, NV400-SP, NV400-SEP, NV400-HEP, NV400-REP

● Operating Characteristics

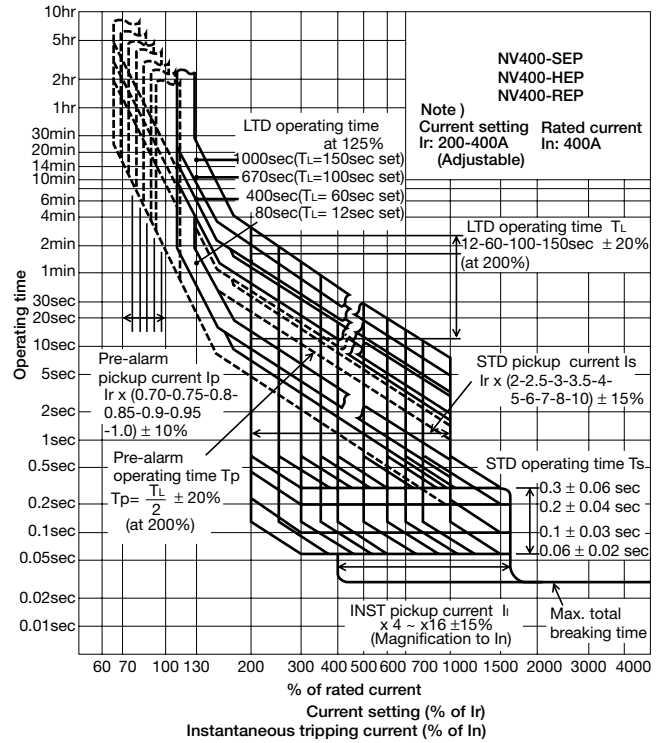
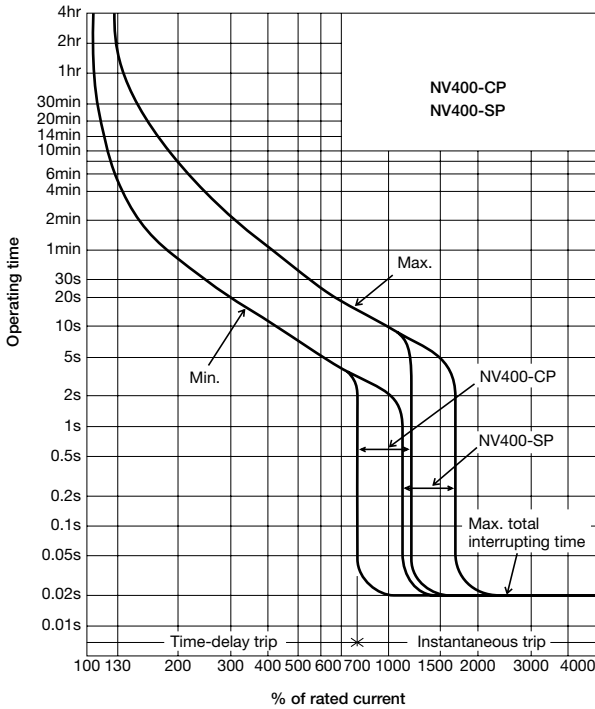

● Temperature Characteristics

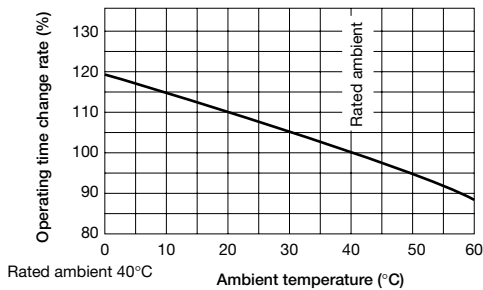

Note : For NV400-SEP/HEP/REP, please refer to Page 68.

Standard attached parts (Front connection)

Mounting screw M6X60 (4pcs)
Insulation barrier (3P: 4pcs, 4P: 6pcs)

● Earth-Leakage Tripping Characteristics

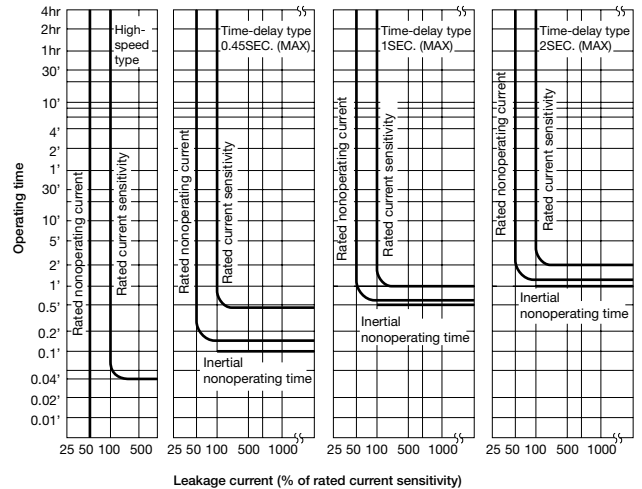

● NV630-CP, NV630-SP, NV630-SEP, NV630-HEP, NV800-SEP, NV800-HEP

● Operating Characteristics

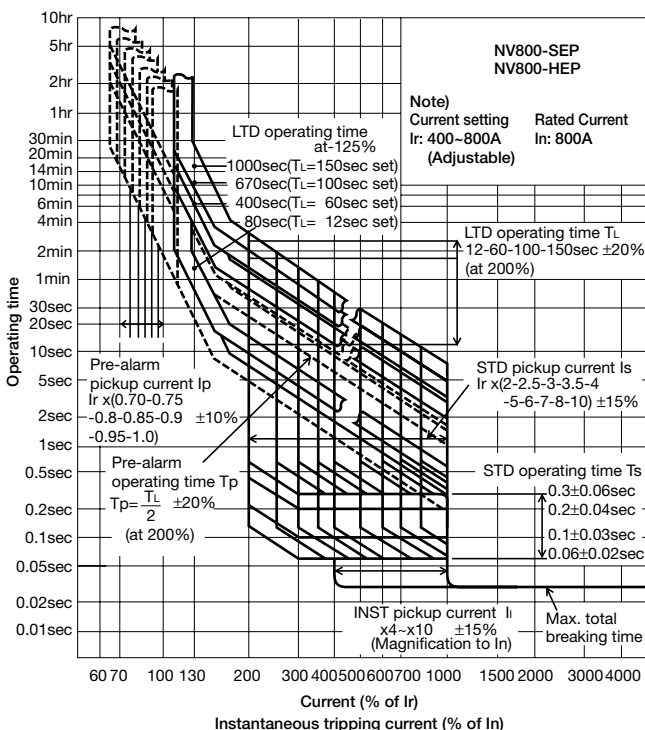
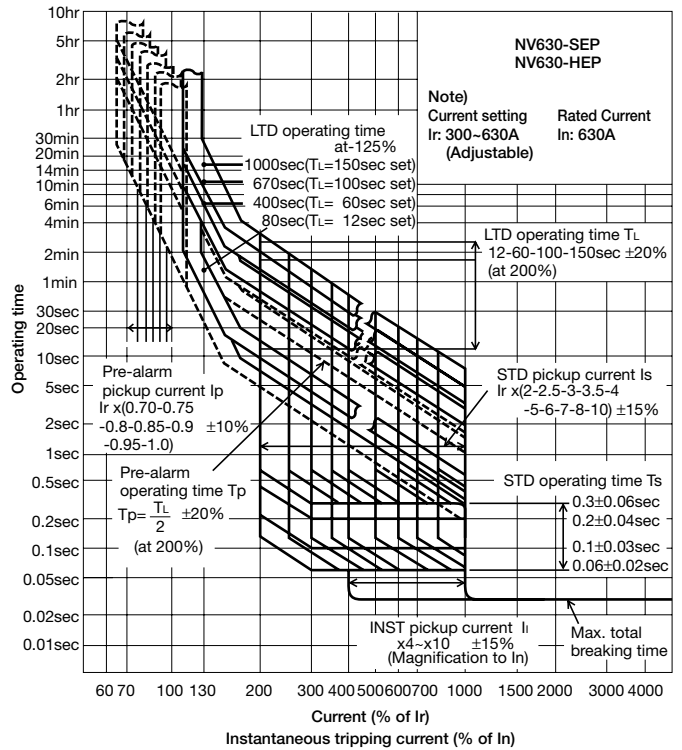
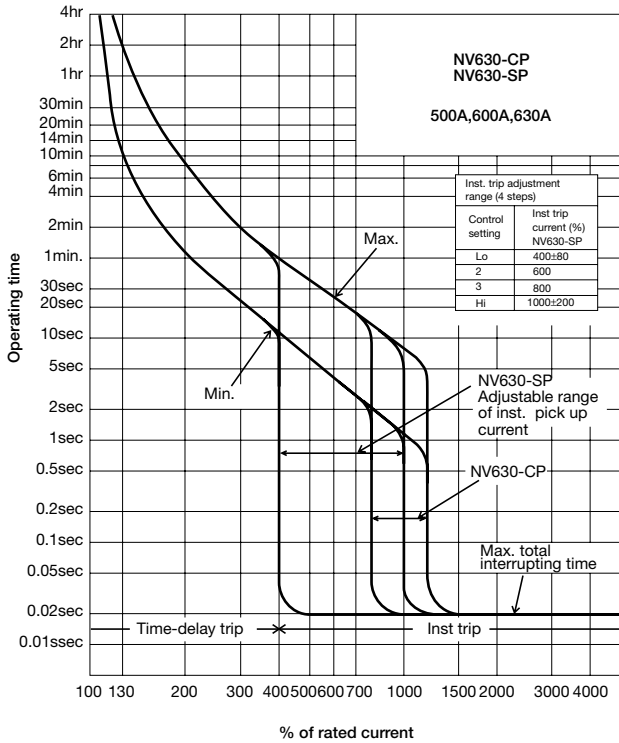

● Temperature Characteristics

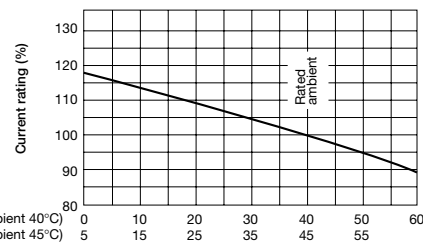

● Earth-Leakage Tripping Characteristics

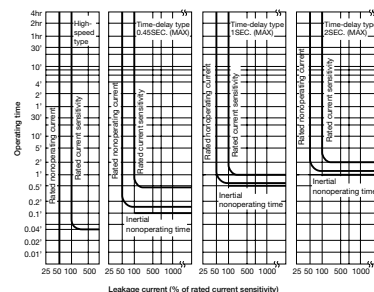

Standard attached parts (Front connection)

- Mounting screw M6x35 (4pcs)
- Insulation barrier (3P: 2pcs, 4P: 3pcs)

CHARACTERISTICS

MINIATURE CIRCUIT BREAKERS

MCB

● BH-D

● Operating Characteristics

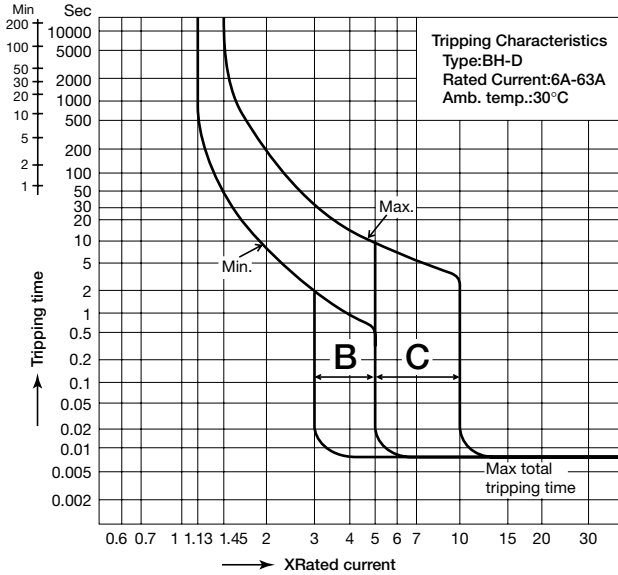

● Temperature Characteristics

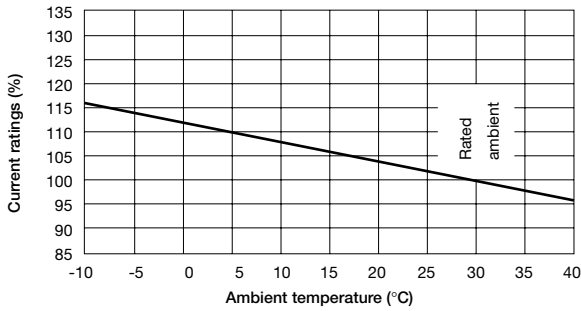

● BV-D

● Operating Characteristics

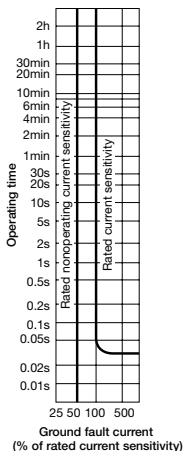

● BH BH-P

● Operating Characteristics

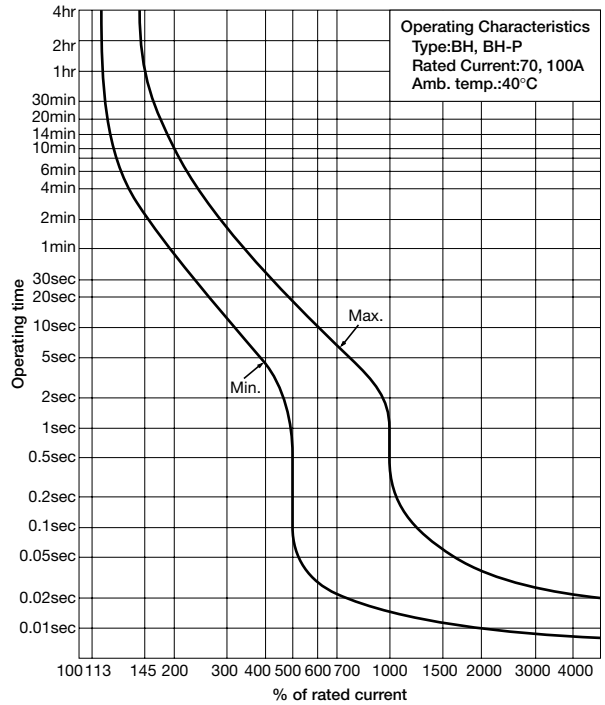

● Ambient Compensating Curve

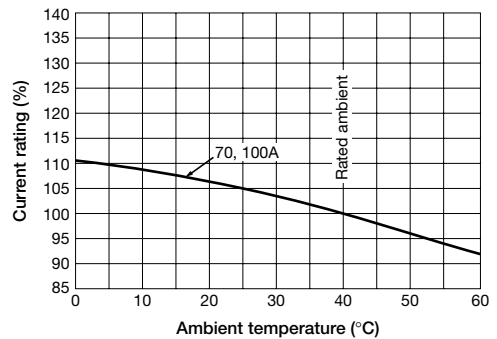

● **BH-S**

● **BH-PS**

● **Operating Characteristics**

● **Operating Characteristics**

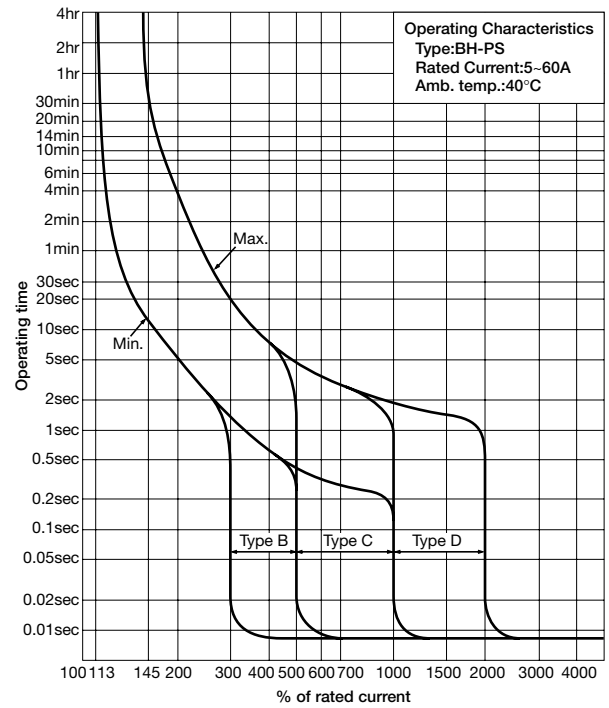
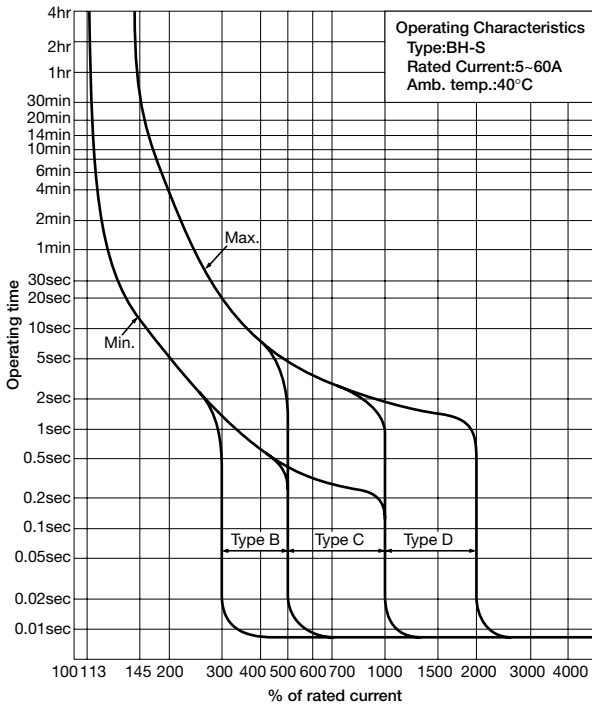

● **Ambient Compensating Curve**

● **Ambient Compensating Curve**

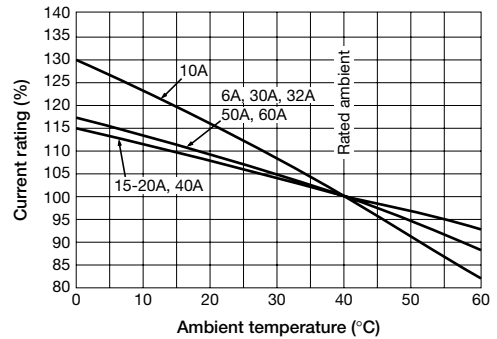
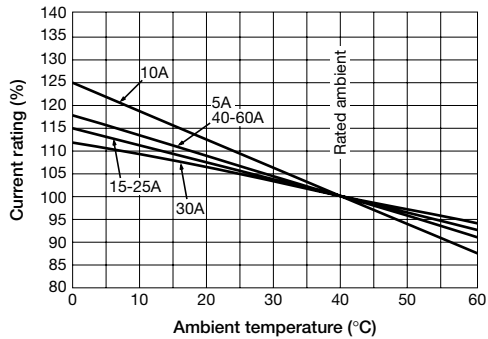

CHARACTERISTICS

MINIATURE CIRCUIT BREAKERS

CPs

● CP30-BA

● Operating Characteristics

Instantaneous type (I)

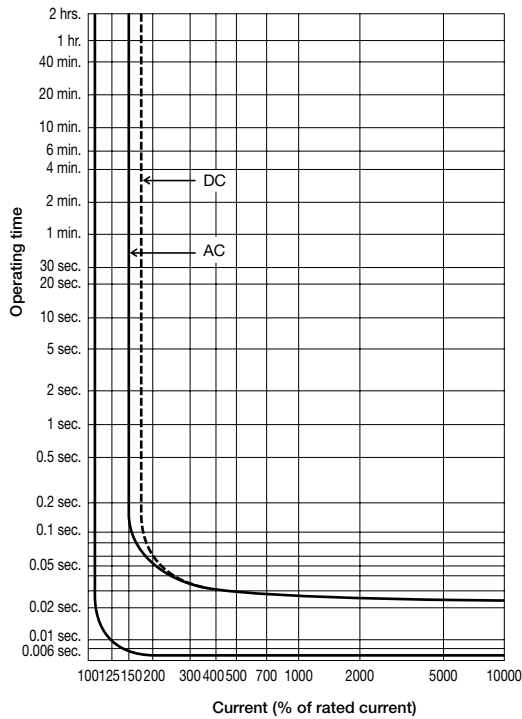

Medium-speed type (M)

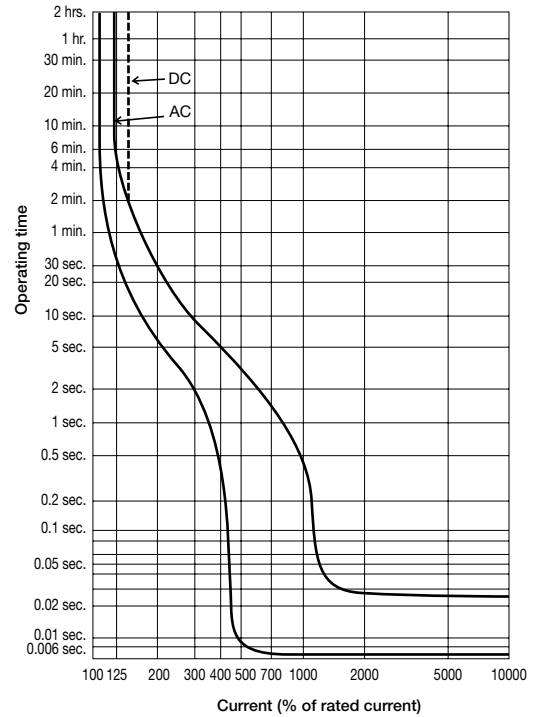

Medium-speed type with inertial delay (MD)

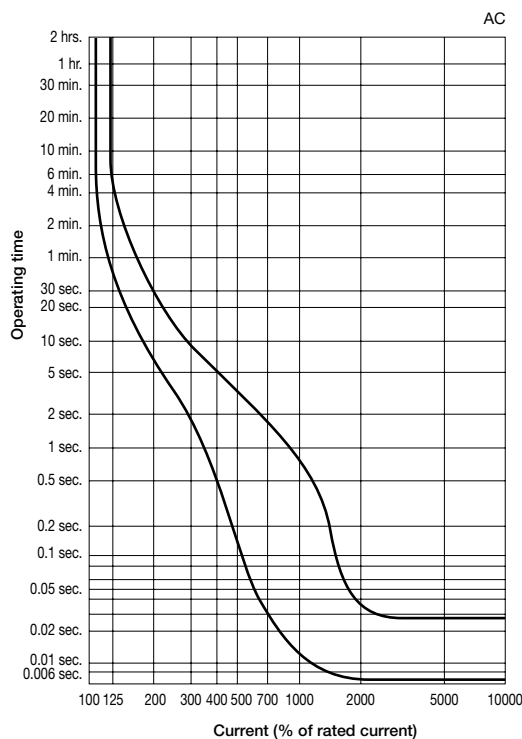

● Temperature Characteristics

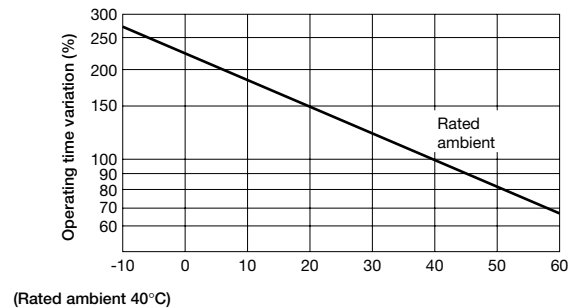

CHARACTERISTICS

● NF50-HRP NF100-CP NF100-SP NF100-HP NF100-CP T/A NF100-SP T/A NF100-HP T/A NF100-SEP NF100-HEP MB100-SP

Front connection

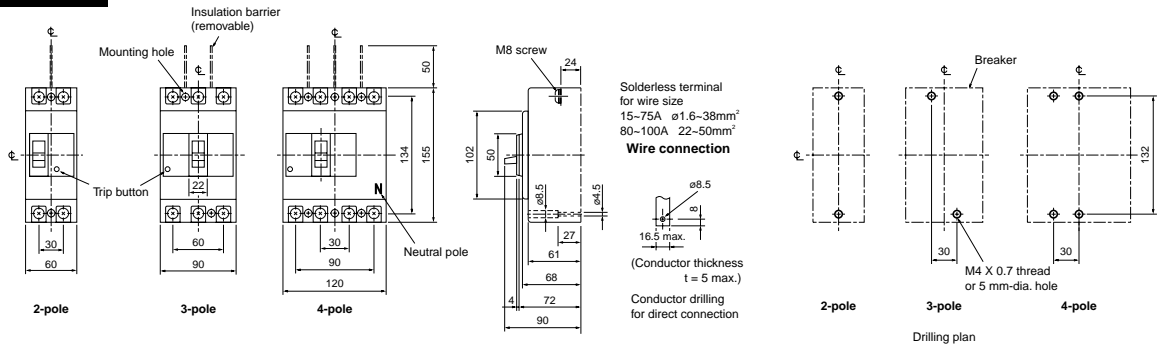

Rear connection

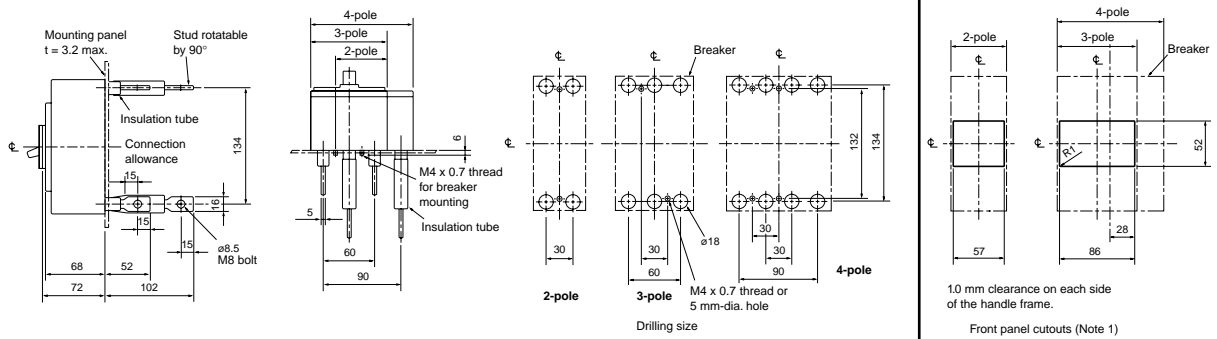

Flush plate

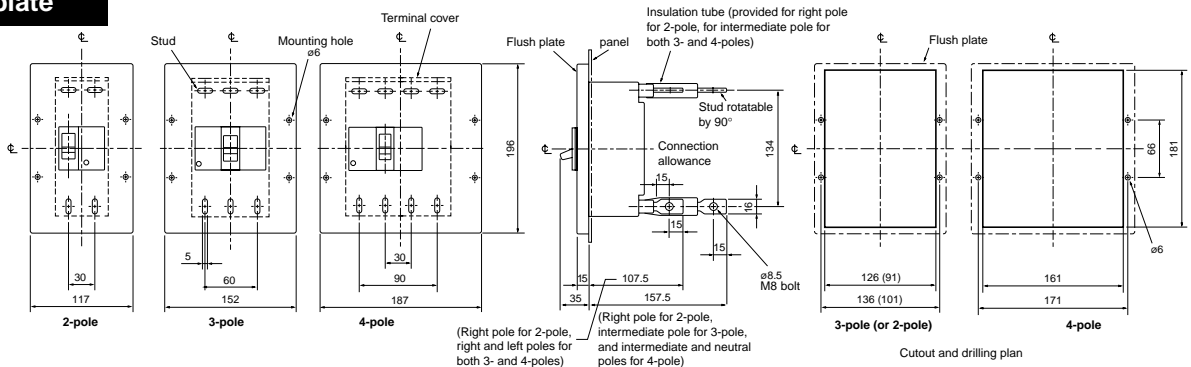

Plug-in

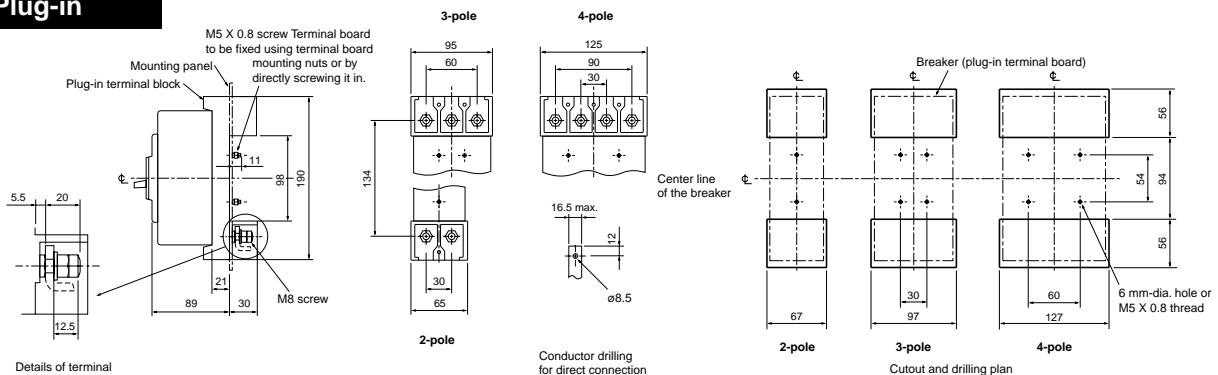

Note: The conventional drilling/cutout plan of conventional breakers may also be used on the front panel.

- Remarks:
1. Two-pole models of NF50-HRP, NF100-HP, NF100-CP T/A, NF100-SP T/A, and NF100-HP T/A are 3-pole models with the central pole removed.
 2. NF50-HRP, NF100-CP and NF100-CP T/A are available in 2- and 3-pole only, NF100-SEP and NF100-HEP in 3- and 4-pole only, and MB100-SP in 3-pole only.

● NF160-SP NF160-HP NF160-SP T/A NF160-HP T/A NF250-CP NF250-SP NF250-HP NF250-CP T/A NF250-SP T/A NF250-HP T/A NF250-SEP NF250-HEP MB225-SP

Front connection

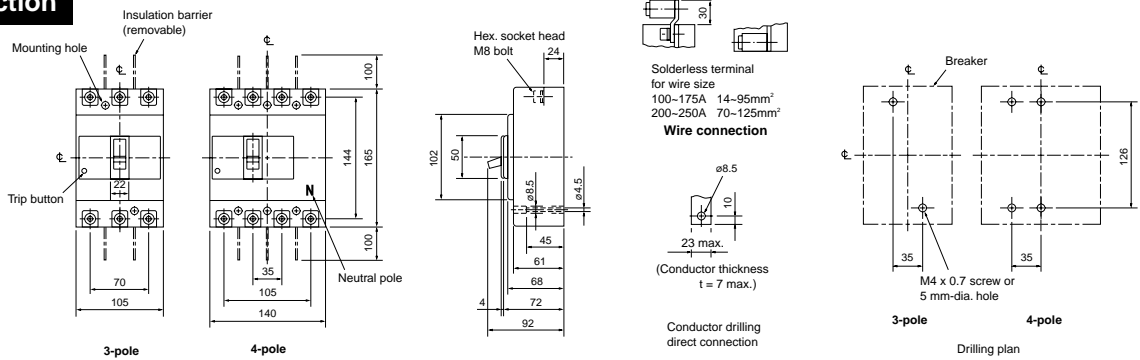

Rear connection

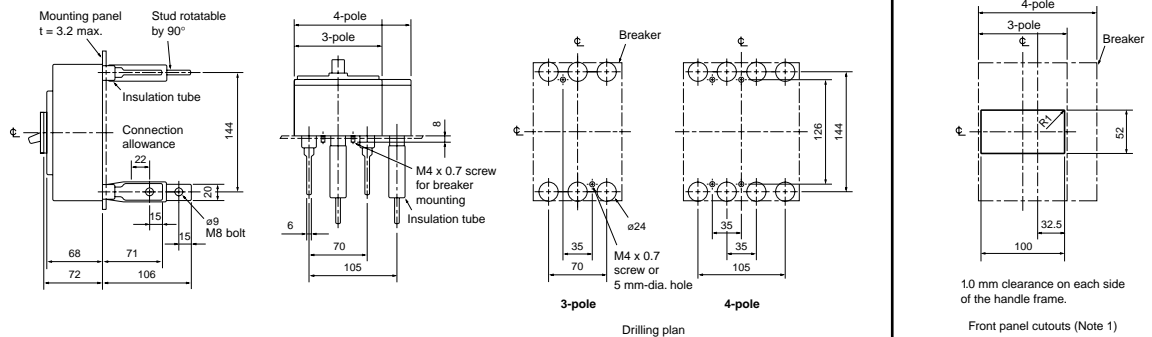

Flush plate

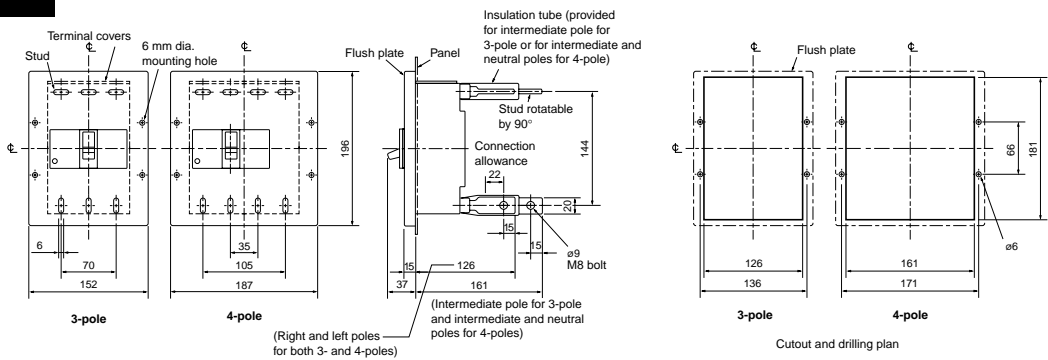

Plug-in

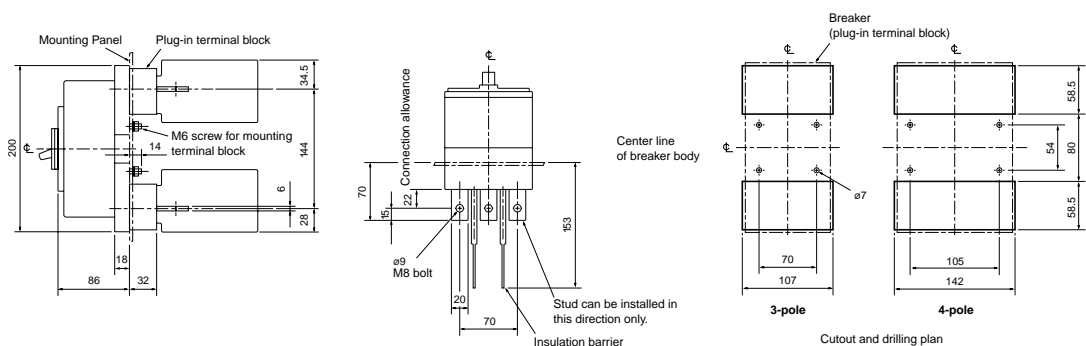

Remarks: 1. Two-pole models are 3-pole models with the central pole removed.
2. NF250-CP and NF250-CP T/A are available in 2- and 3-pole only.
NF250-SEP and NF250-HEP are available in 3- and 4-pole only.
MB225-SP is available in 3-pole only.

DIMENSIONS

● NF400-CP NF400-SP NF400-SEP NF400-HEP NF400-REP

Front connection

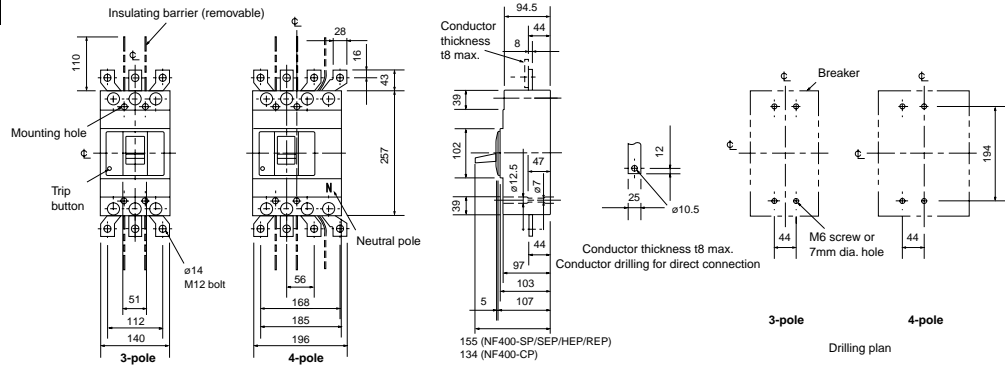

Rear connection

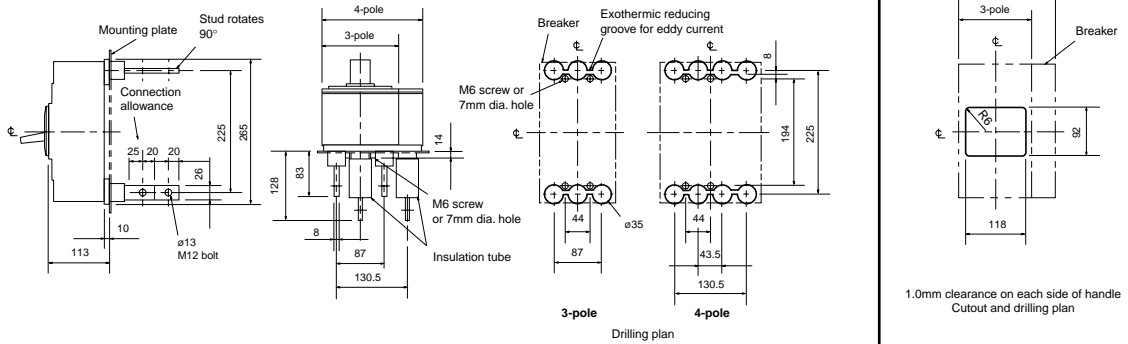

Flush plate

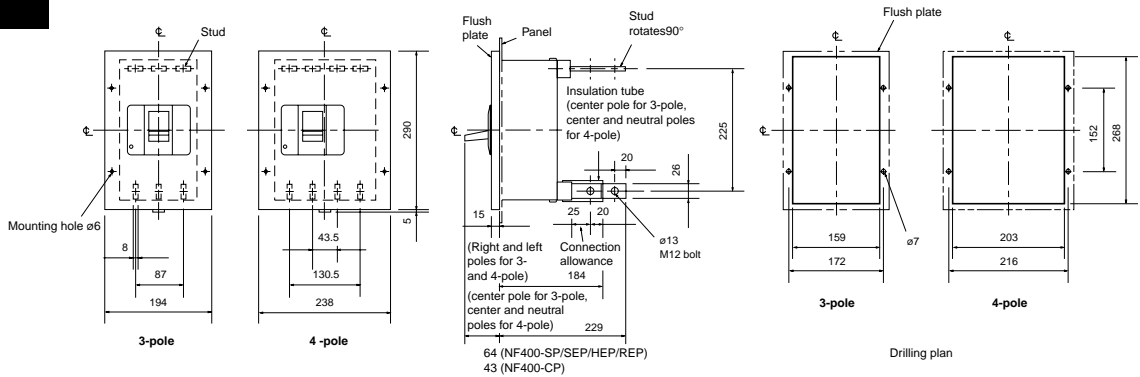

Plug-in

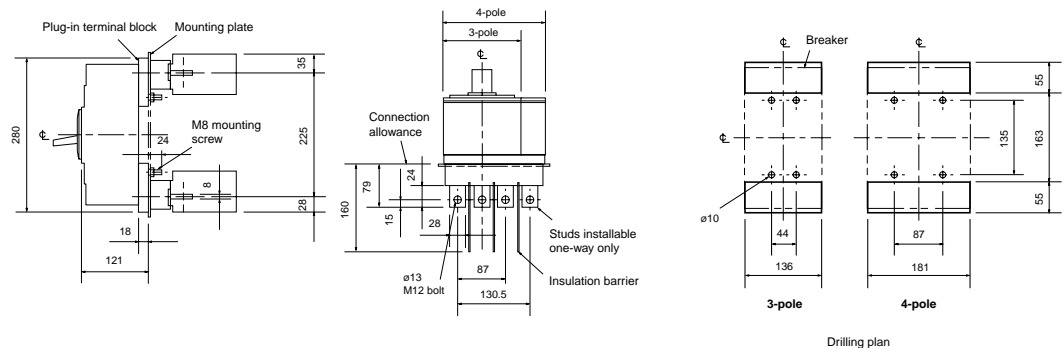

Remark: Two-pole models are 3-pole models with the central pole removed.

DIMENSIONS

MOLDED-CASE CIRCUIT BREAKERS

MCCBs

● NF400-UEP

Front connection

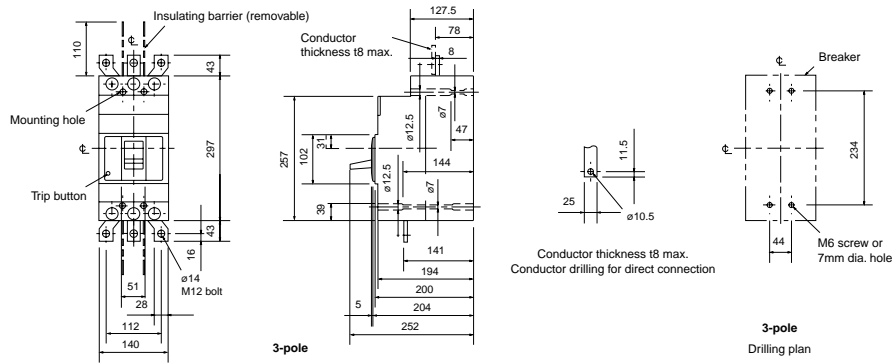

Rear connection

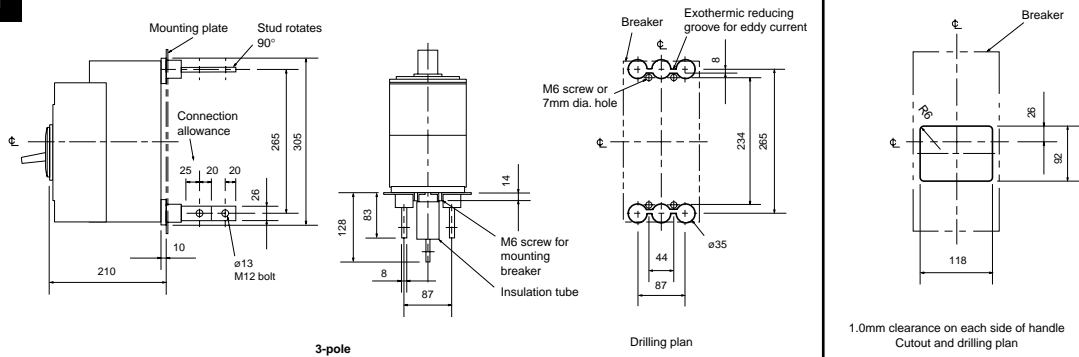

Flush plate

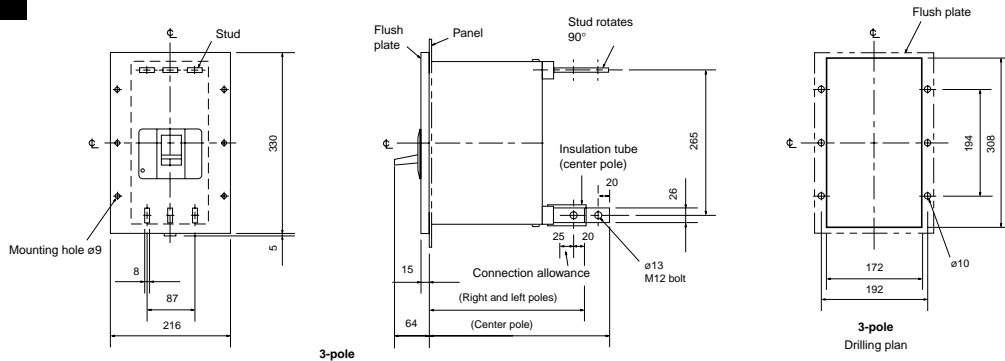

Plug-in

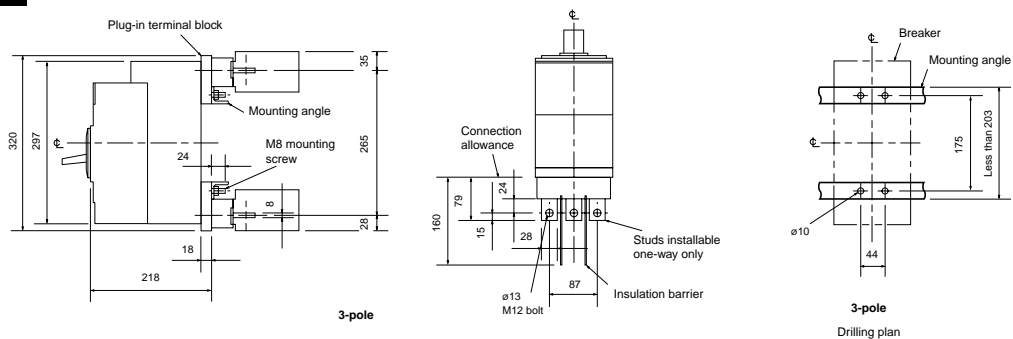

Remark: The 4-pole dimensions are identical for 4-pole NF630-UEP and NF800-UEP models.

● **NF630-CP NF630-SP NF630-SEP NF630-HEP NF630-REP**
NF800-CEP NF800-SDP NF800-SEP NF800-HEP NF800-REP

Front connection

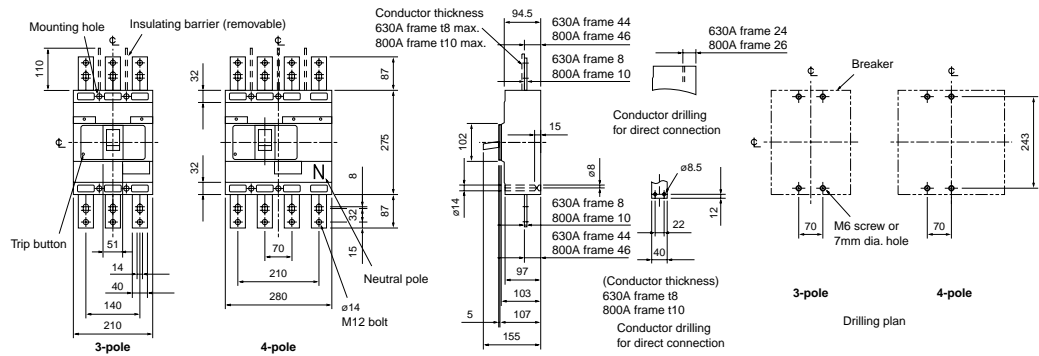

Rear connection

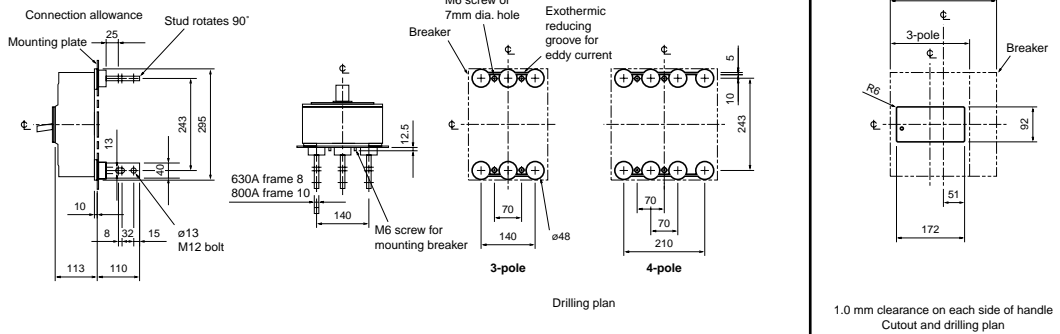

Flush plate

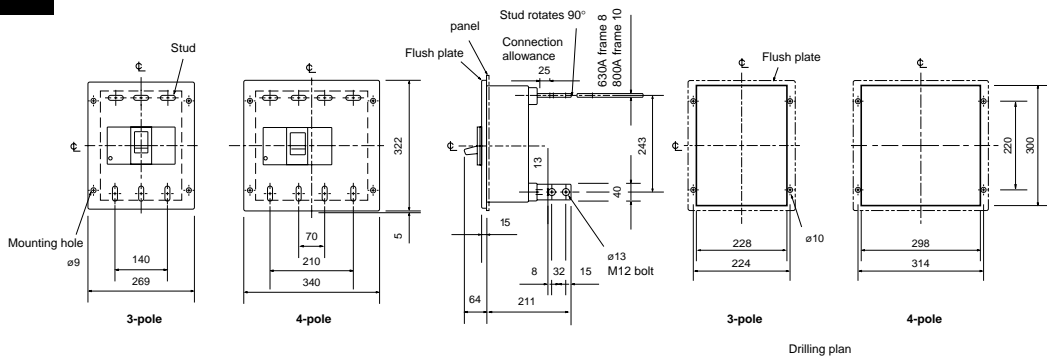

Plug-in

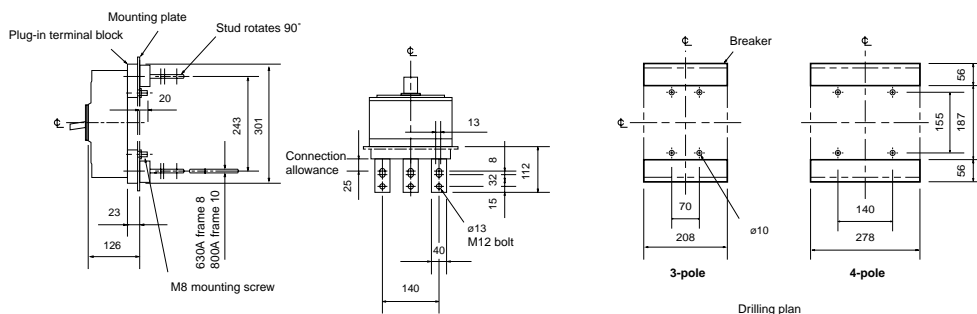

DIMENSIONS

MOLDED-CASE CIRCUIT BREAKERS

MCCBs

● NF630-UEP NF800-UEP NF400-UEP (4-pole)

Front connection

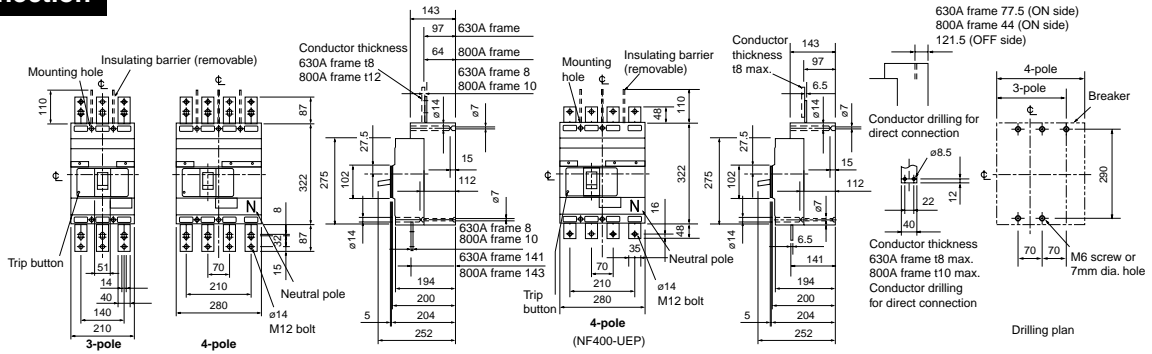

Rear connection

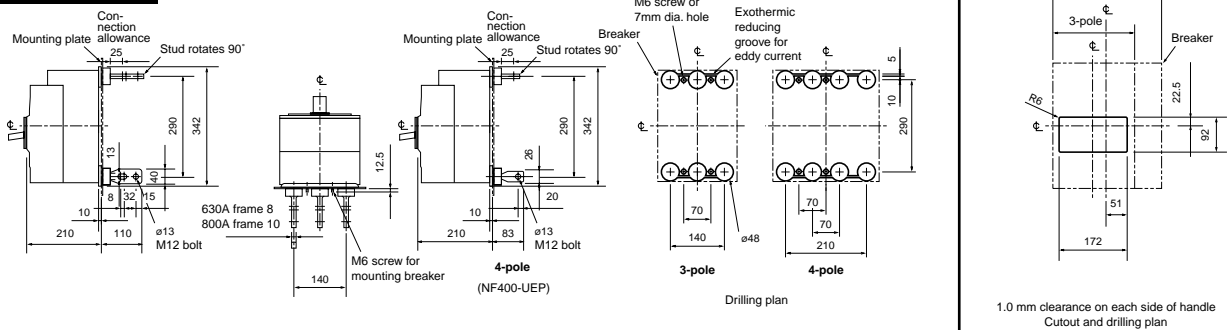

Flush plate

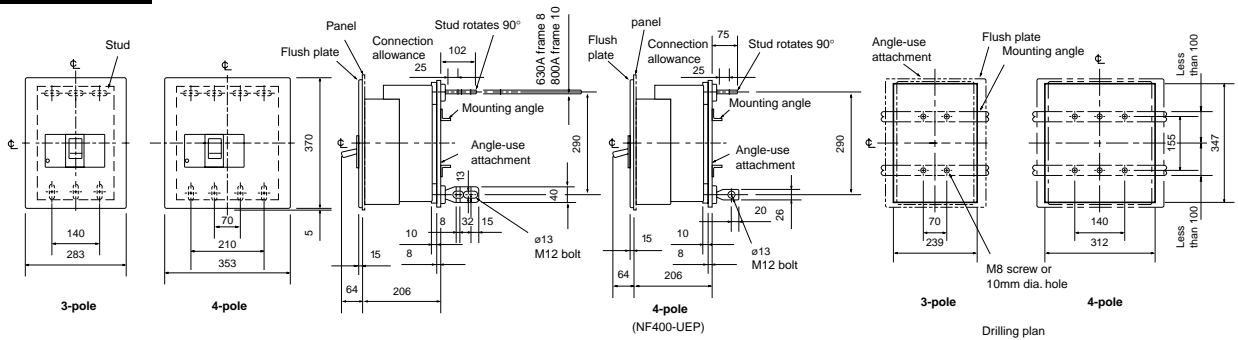

Plug-in

(except NF800-UEP)

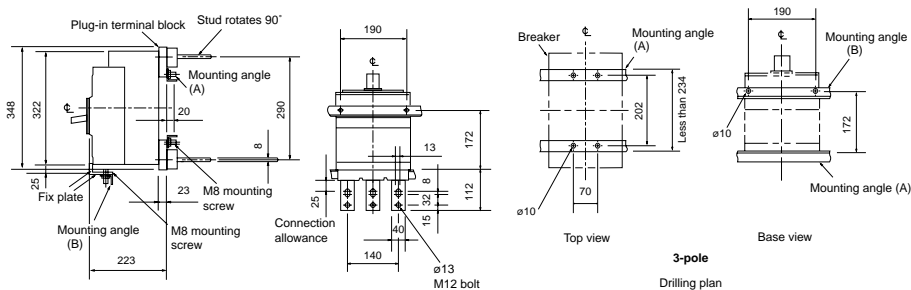

DIMENSIONS

DIMENSIONS

EARTH LEAKAGE CIRCUIT BREAKERS

ELCBs

• NV30-CS MN30-CS

Front connection

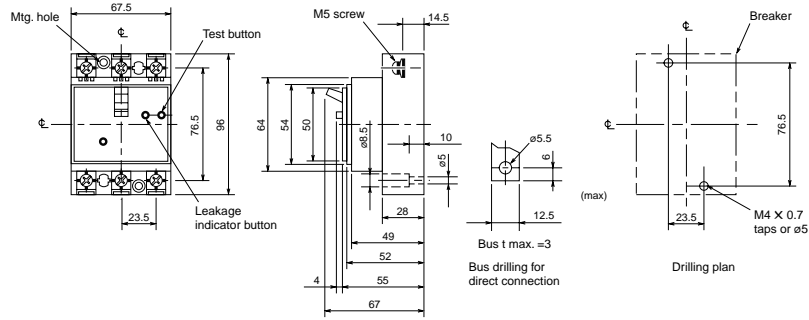

Rear connection

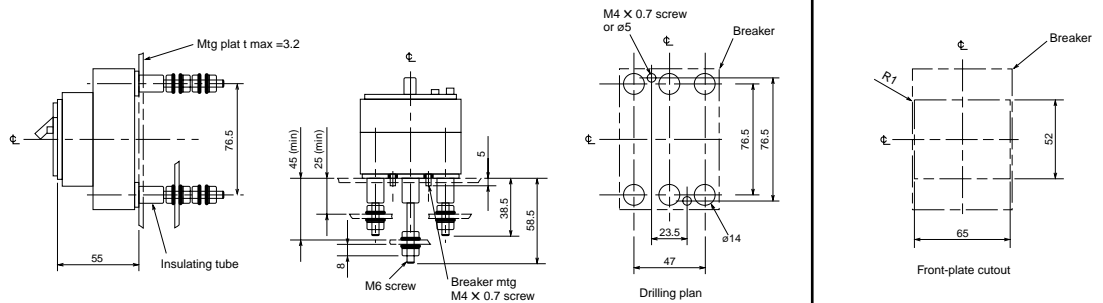

DIMENSIONS

EARTH LEAKAGE CIRCUIT BREAKERS

ELCBs

- NV30-SP NV50-CP NV50-HP NV60-CP NV60-HP MN50-CP MN50-SP

Front connection

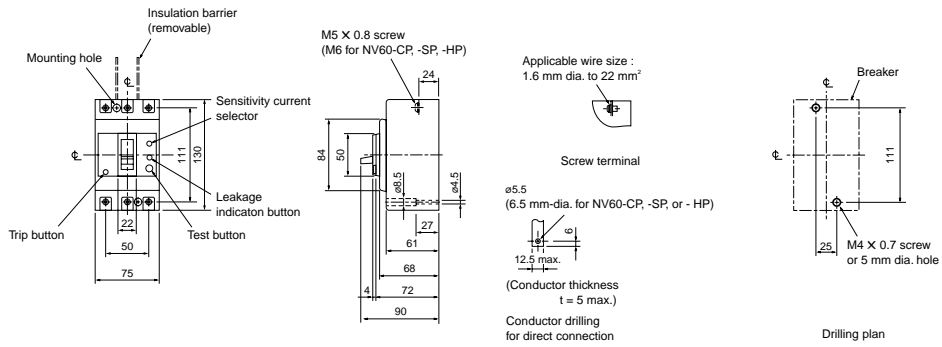

Rear connection

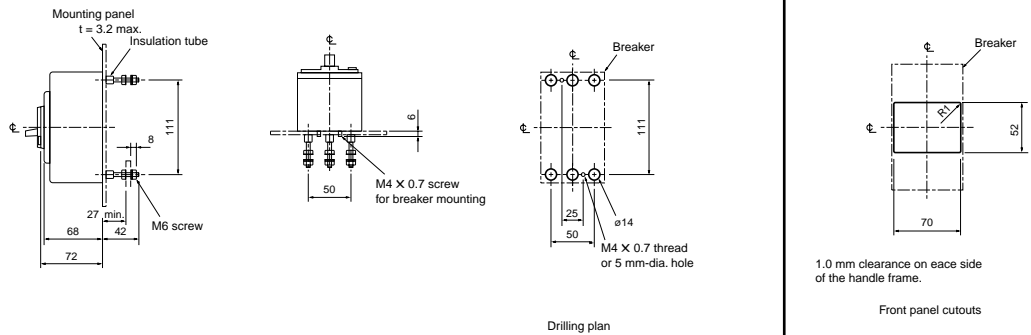

Flush plate

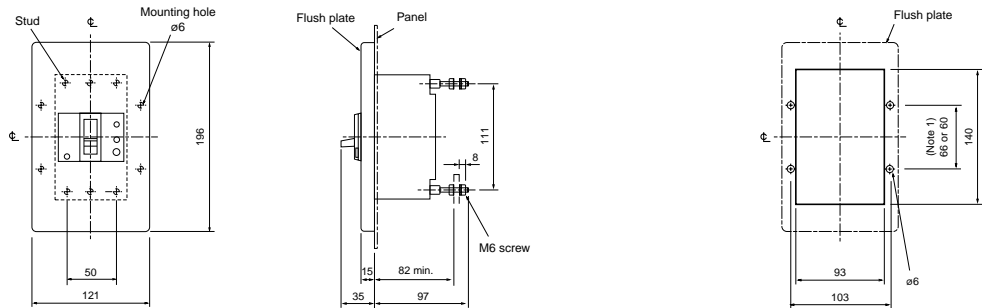

Plug-in

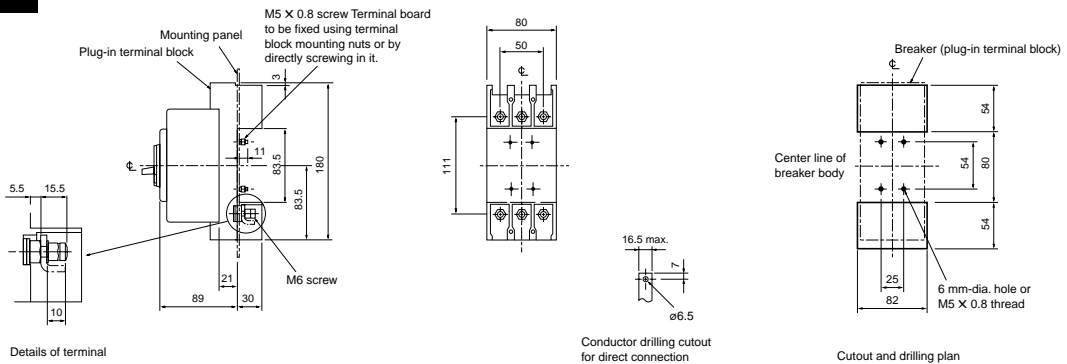

● NV100-CP NV100-SP NV100-HP NV100-SEP NV100-HEP MN100-SP

Front connection

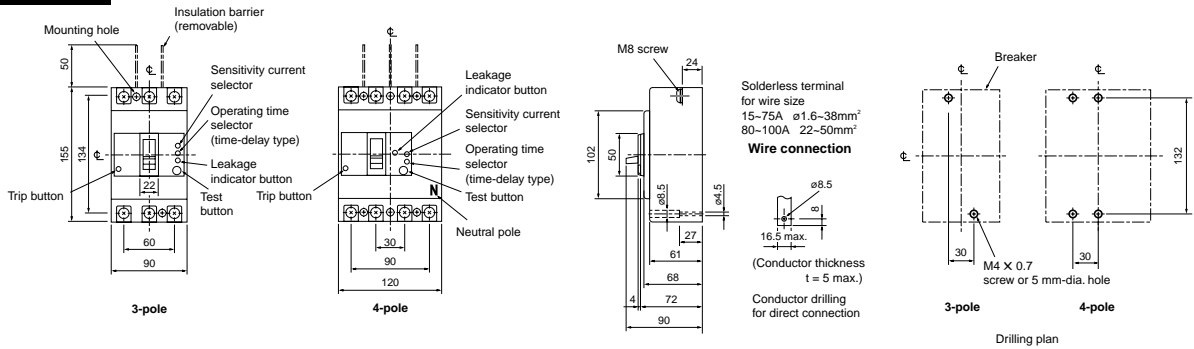

Rear connection

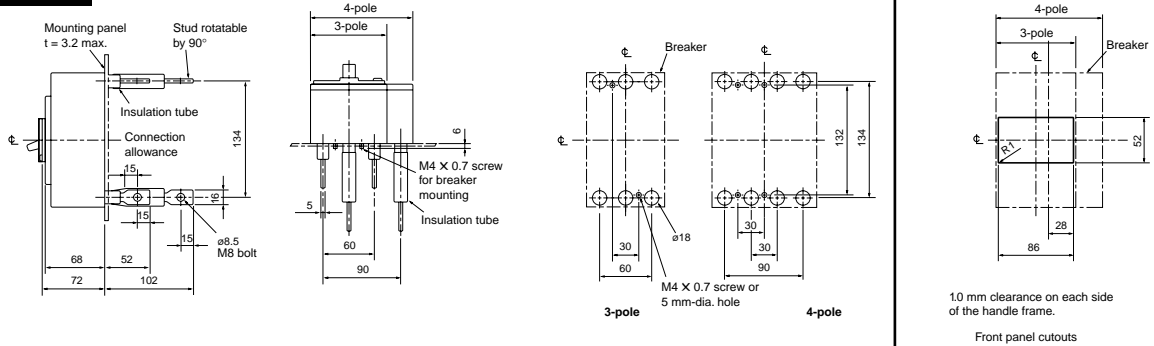

Flush plate

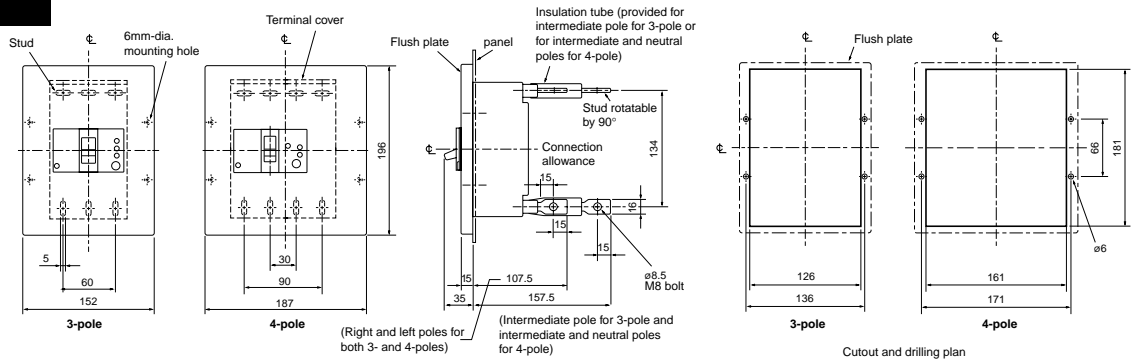

Plug-in

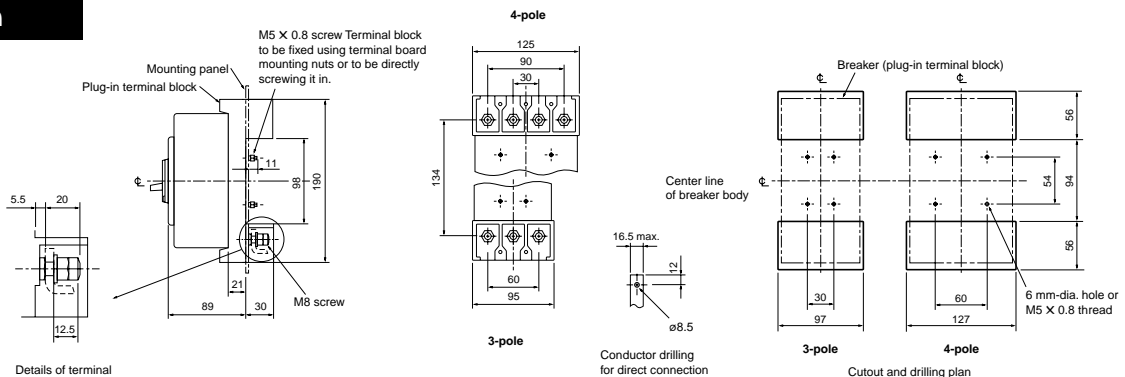

Remarks : NV100-CP, NV100-SP NV100-HP and MN100-SP are only available as 3-pole models.

DIMENSIONS

● NV225-CP NV225-SP NV225-HP NV225-SEP NV225-HEP MN225-SP

Front connection

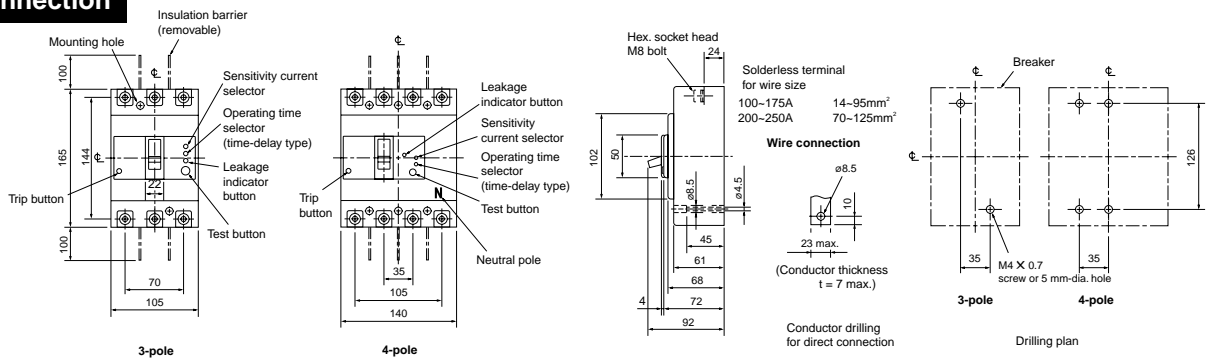

Rear connection

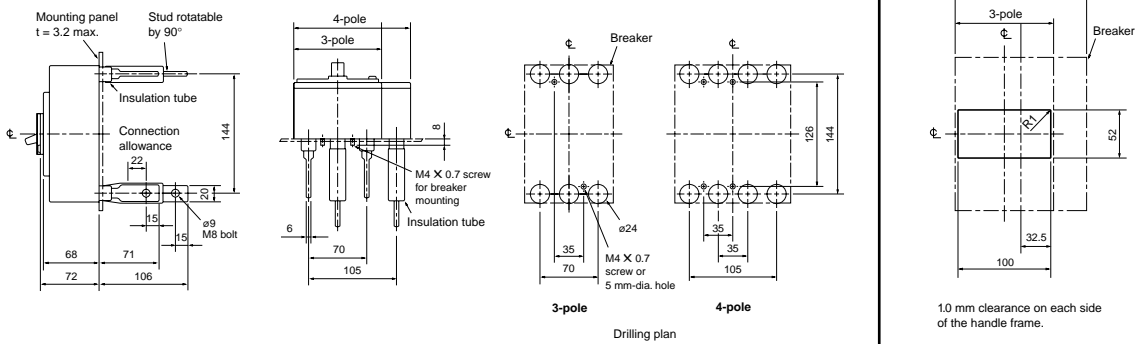

Flush plate

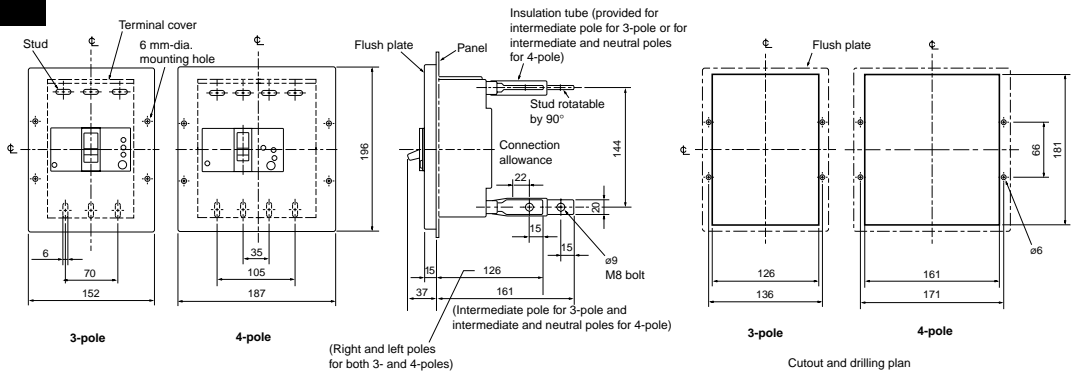

Plug-in

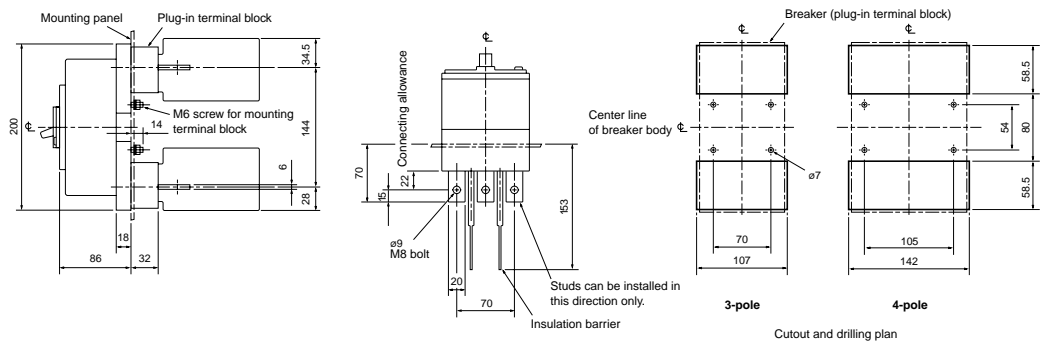

Remark: NV225-CP/SP/HP and MN225-SP are only available as 3-pole models.

DIMENSIONS

EARTH-LEAKAGE CIRCUIT BREAKERS

ELCBs

● NV225-RP

Front connection

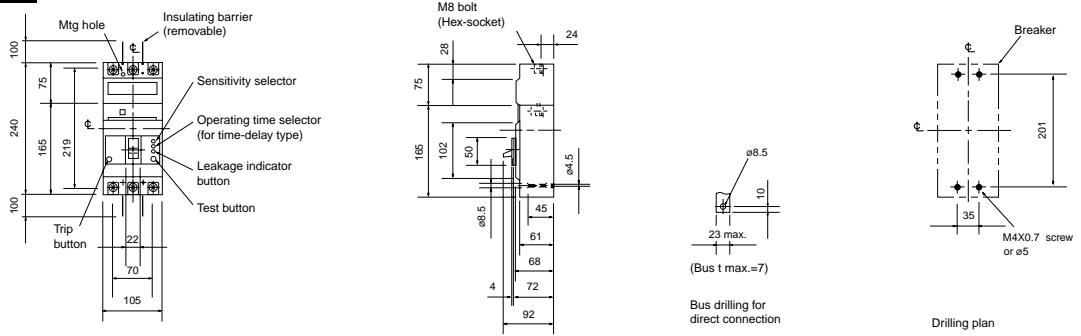

Rear connection

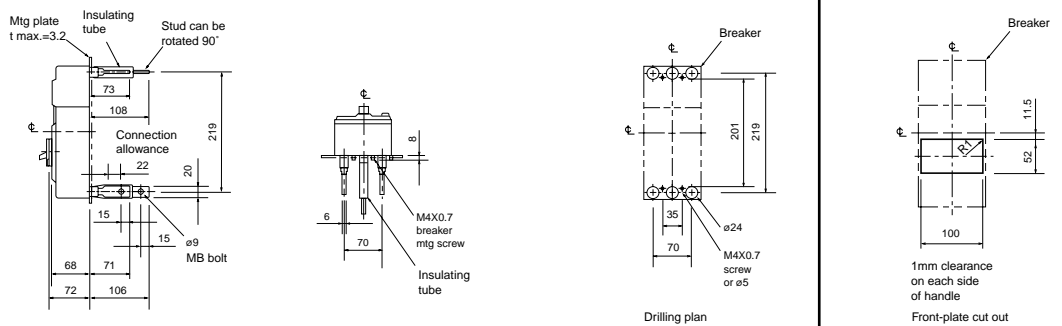

Flush plate

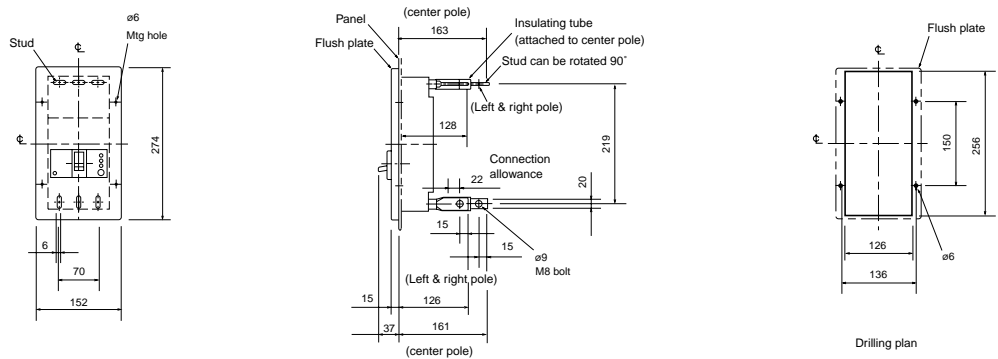

Plug-in

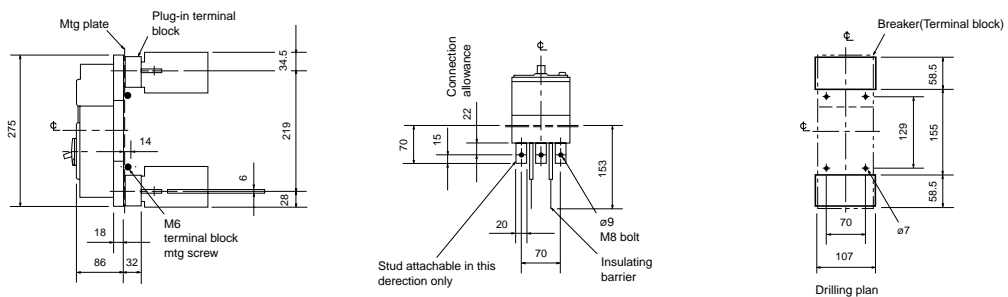

DIMENSIONS

● NV400-CP NV400-SP NV400-SEP NV400-HEP NV400-REP

Front connection

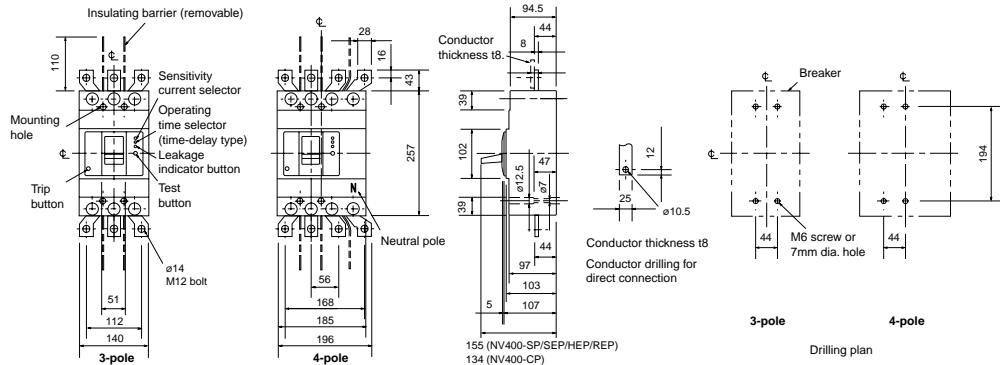

Rear connection

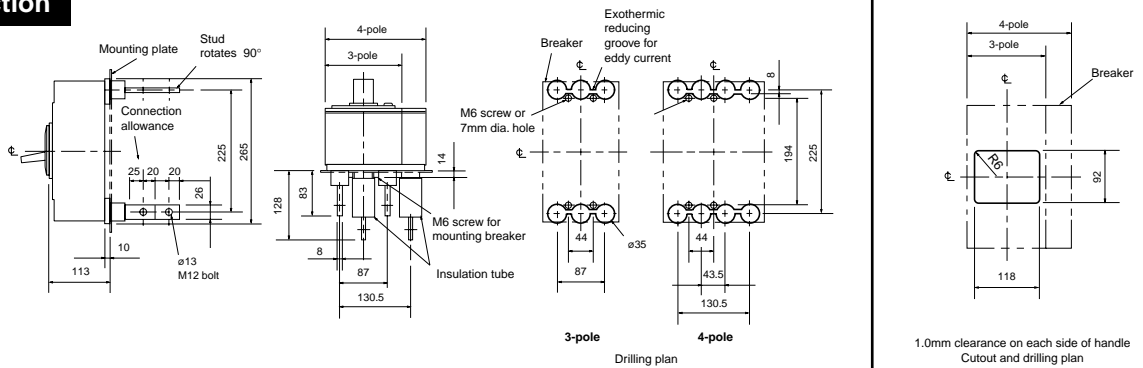

Flush plate

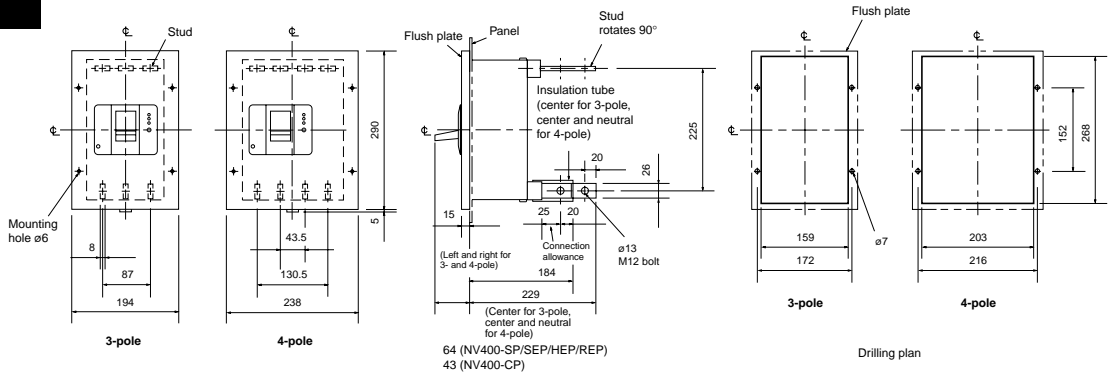

Plug-in

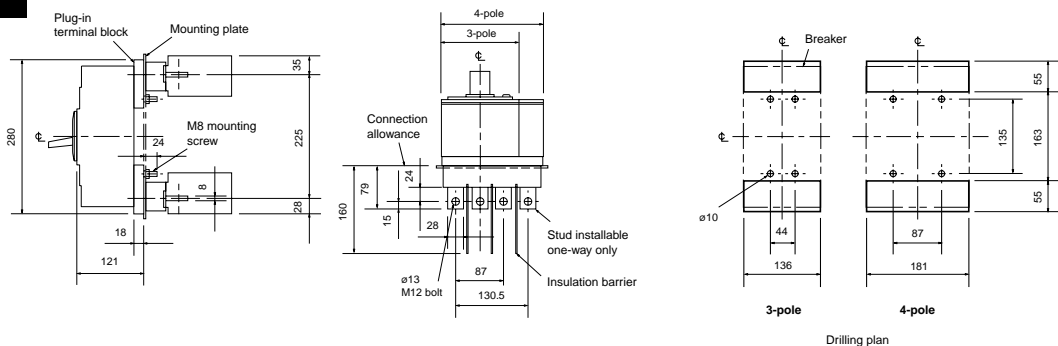

DIMENSIONS

EARTH-LEAKAGE CIRCUIT BREAKERS

ELCBs

- NV630-CP NV630-SP NV630-SEP NV630-HEP NV800-SEP NV800-HEP

Front connection

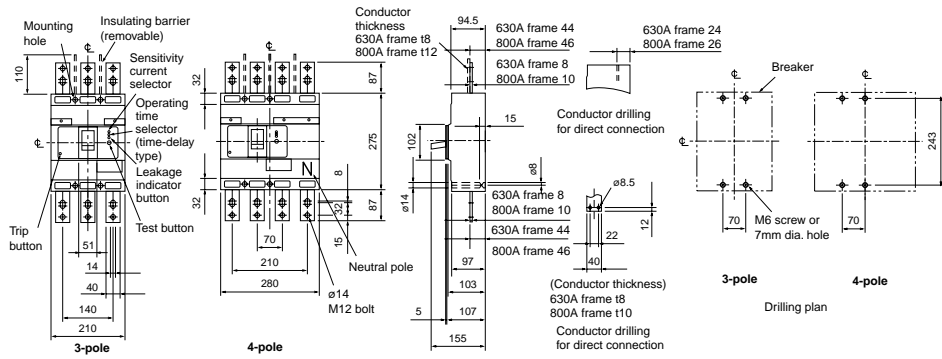

Rear connection

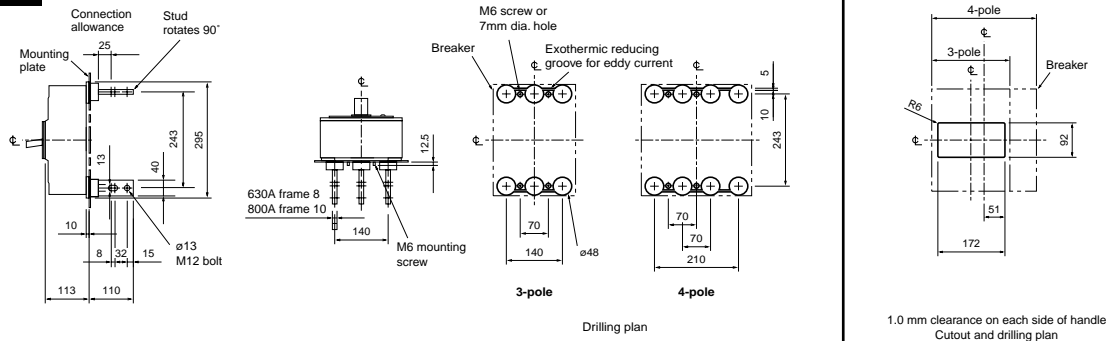

Flush plate

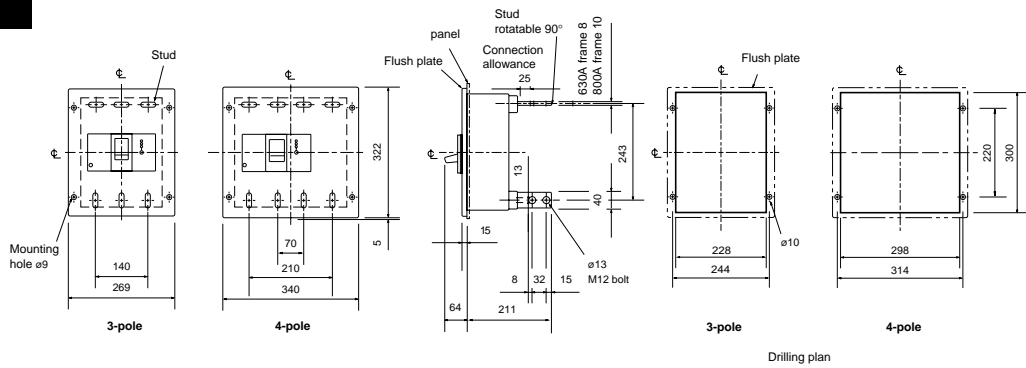

Plug-in

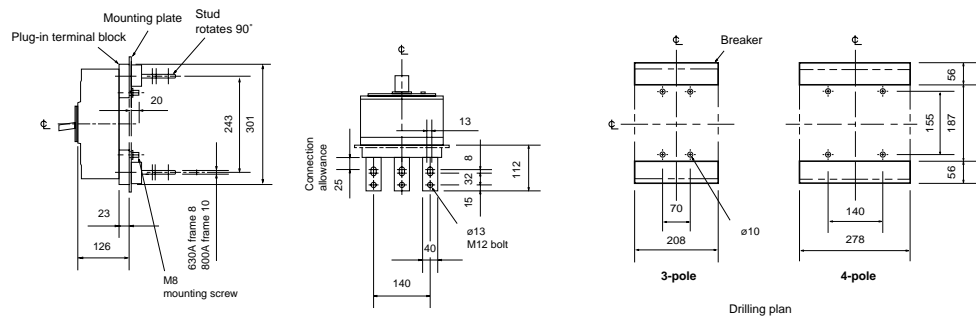

DIMENSIONS

MINIATURE CIRCUIT BREAKERS

MCBs

● BH

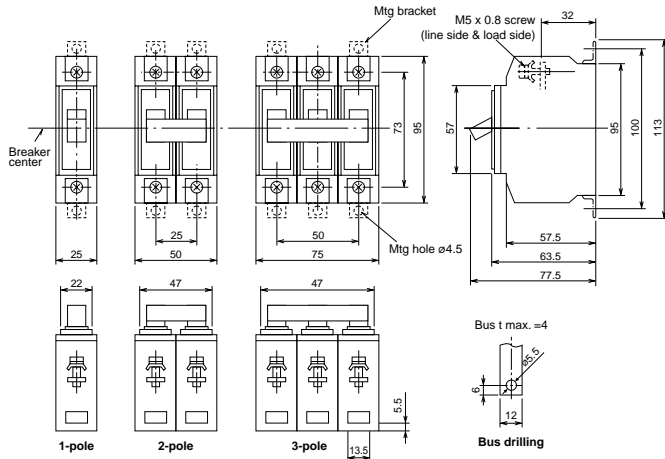

Note: Two mounting brackets are used for single-pole breakers. and four for two-pole and three-pole breakers.

● BH-S

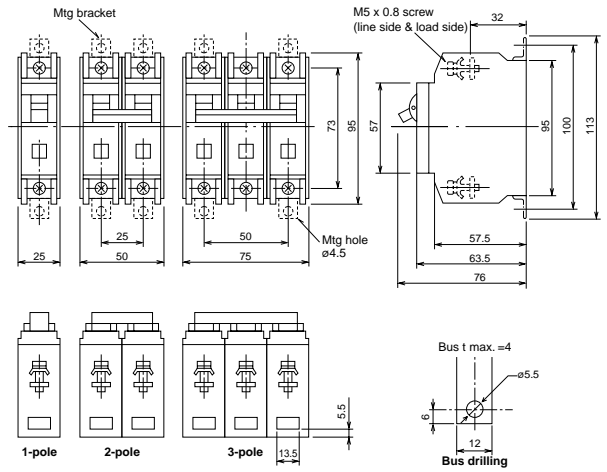

Note: Two mounting brackets are used for single-pole breakers. and four for two-pole and three-pole breakers.

● BH-P

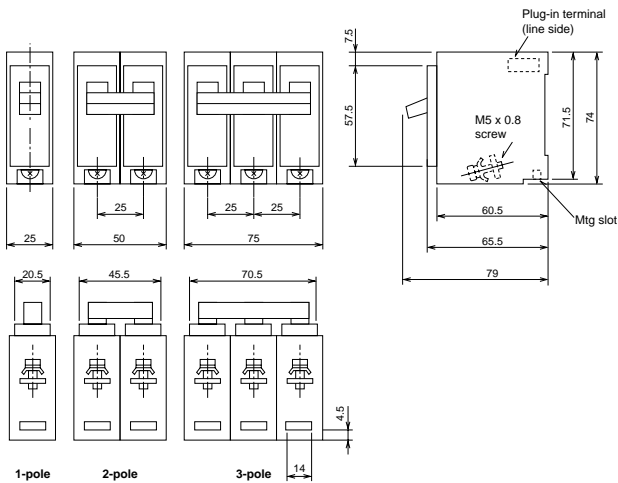

● BH-PS

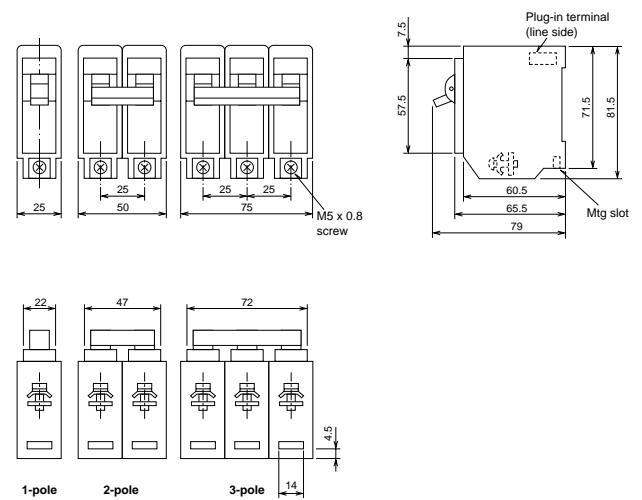

● BH-D6

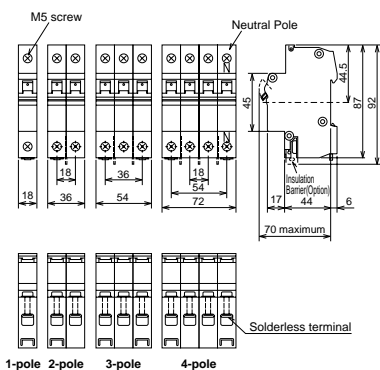

● BV-D

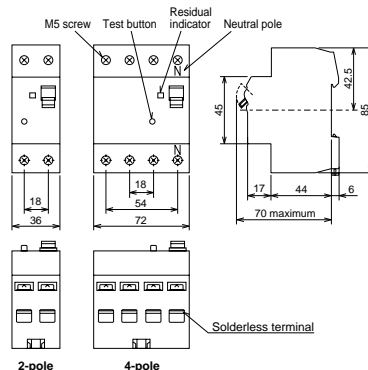

● KB-D

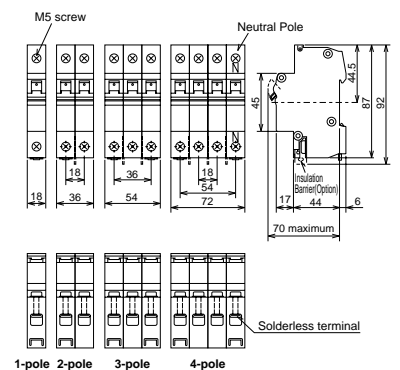

30~250AF

Series	A frame	Model number		External dimension standardization					Electronic breakers			Internal accessories	External accessories		Electronic circuits		Earth-leakage alarm		
		Former	New	NF=NV	C=S	Same module for 4-pole	Standard 68mm height	Same panel size for NF/NV	Multiple operating char.	Pre-alarm			Reverse connection	Electrically operated	HL/HL-S	Three voltages available		High-speed/Time-delay/operating time switching	Loads via ECA leads
										SSR output	Contact output								
Molded-case circuit breakers	NF-C	NF50/60-CS	NF50/60-CP	●	●	—	●	●	—	—	—	●	●	—	●	—	—	—	
		NF100-CS	NF100-CP	●	●	—	●	●	—	—	—	●	●	●	●	—	—	—	
		NF250-CS	NF250-CP	●	●	—	●	●	—	—	—	●	●	●	●	—	—	—	
	NF-S	NF50/60-SH	NF50/60-HP	●	●	●	●	●	—	—	—	●	●	—	●	—	—	—	
		NF100-SS	NF100-SP	●	●	●	●	●	—	—	—	●	●	●	●	—	—	—	
		NF100-SH	NF100-HP	●	●	●	●	●	—	—	—	●	●	●	●	—	—	—	
		—	NF100-SEP/HEP	●	●	●	●	●	●	●	● As standard/Option	● Option	●	●	●	●	—	—	—
		NF160-SS, NF250-SS	NF160-SP, NF250-SP	●	●	●	●	●	—	—	—	—	●	●	●	●	—	—	—
NF160-SH, NF250-SH	NF160-HP, NF250-HP	●	●	●	●	●	—	—	—	—	●	●	●	●	—	—	—		
NF250-SE	NF250-SEP/HEP	●	●	●	●	●	●	●	● As standard/Option	● Option	●	●	●	●	—	—	—		
Earth leakage circuit breakers	NV-C	NV50/60-CF	NV50/60-CP	●	●	—	●	●	—	—	—	—	●	—	●	●	—	—	
		NV100-CF	NV100-CP	●	●	—	●	●	—	—	—	—	●	●	●	●	—	—	
		NV225-CF	NV225-CP	●	●	—	●	●	—	—	—	—	●	●	●	●	—	—	
	NV-S	NV30/50/60-SF	NV30/50/60-SP	●	●	—	●	●	—	—	—	—	●	—	●	●	—	—	
		—	NV50/60-HP	●	●	—	●	●	—	—	—	—	●	—	●	●	—	—	
		NV100-SF	NV100-SP	●	●	—	●	●	—	—	—	—	●	●	●	●	—	—	
		NV100-HB	NV100-HP	●	●	—	●	●	—	—	—	—	●	●	●	●	—	—	
		(NV100-SS 4P)	NV100-SEP/HEP	●	●	●	●	●	●	—	—	● Option	—	●	●	●	●	—	
		NV225-SF	NV225-SP	●	●	—	●	●	—	—	—	—	—	●	●	●	●	—	
		NV225-SB	NV225-HP	●	●	—	●	●	—	—	—	—	—	●	●	●	●	—	
(NV250-SS 4P)	NV225-SEP/HEP	●	●	●	●	●	●	—	—	● Option	—	●	●	●	●	●			
MB	MB30/50-SS MB50-CS	MB30/50-SP MB50-CP	●	●	—	●	●	—	—	—	—	●	●	—	●	—	—		
	MB100-SS	MB100-SP	●	●	—	●	●	—	—	—	—	●	●	—	●	—	—		
	MB225-SS	MB225-SP	●	●	—	●	●	—	—	—	—	●	●	—	●	—	—		
MN	MN50-CF/SF	MN50-CP/SP	●	●	—	●	●	—	—	—	—	—	●	—	●	●	—		
	MN100-SF	MN100-SP	●	●	—	●	●	—	—	—	—	—	●	—	●	●	—		
	MN225-SF	MN225-SP	●	●	—	●	●	—	—	—	—	—	●	—	●	●	—		

● : Improved item for new models

COMPARISON

COMPATIBILITY BETWEEN NEW AND FORMER MODELS

400~800AF

Series	A frame	Model number		External dimension standardization		Cassette-type accessories	Multiple operating char.	Pre-alarm		
		Former	New	NF=NV	Same module for 4-pole			SSR output	Contact output	
Molded-case circuit breakers	NF-C	400	NF400-CS	NF400-CP	●	—	●	—	—	
		630	NF630-CS	NF630-CP	●	—	●	—	—	
		800	NF800-CS	NF800-CEP	●	—	●	●	●	
	NF-S	400	—	NF400-SS	NF400-SP	●	●	●	—	—
			—	NF400-SE	NF400-SEP	●	●	●	●	●
			—	NF400-HEP	—	●	●	●	●	●
			—	NF400-REP	—	●	—	●	●	●
		630	—	NF630-SS	NF630-SP	●	●	●	—	—
			—	NF630-SE	NF630-SEP	●	●	●	●	●
			—	NF630-HEP	—	●	●	●	●	●
			—	NF630-REP	—	●	—	●	●	●
		800	—	NF800-SS	NF800-SEP	●	●	●	●	●
			—	NF800-SSD	NF800-SDP	—	●	●	—	—
			—	NF800-HEP	—	●	●	●	●	●
			—	NF800-REP	—	●	—	●	●	●
	NF-U	400	NF400-UR	NF400-UEP	—	—	●	●	●	●
		630	NF630-UR	NF630-UEP	—	●	●	●	●	●
		800	NF800-UR	NF800-UEP	—	●	●	●	●	●
	Earth leakage circuit breakers	NV-C	400	NV400-CF	NV400-CP	●	—	●	—	—
			630	NV630-CA	NV630-CP	●	—	●	—	—
NV-S		400	—	NV400-SF	NV400-SP	●	—	●	—	—
			—	NV400-SS	NV400-SEP	●	—	●	●	●
			—	NV400-SB 4P	NV400-SEP 4P	●	●	●	●	●
			—	NV400-HEP	—	●	—	●	●	●
			—	NV400-REP	—	●	—	●	●	●
		630	—	NV600-SB 3P	NV630-SP	●	—	●	—	—
			—	NV630-SEP 3P	—	●	—	●	●	●
			—	NV600-SB 4P	NV630-SEP 4P	●	●	●	●	●
		800	—	NV630-HEP	—	●	—	●	●	●
			—	NV800-SB	NV800-SEP	●	—	●	●	●
			—	NV800-HEP	—	●	—	●	●	●

● Improved item for new models

COMPARISON

OTHER CHANGES

30~800AF

● Appearance

● Former (example: NF100-SS)



● New (example: NF100-SP)



Includes a trip button within the panel cutout. New model indicates IEC60947-2 Icu/lcs on the nameplate.

● Former (example: NV100-SF)



● New (example: NV100-SP)



Includes a dial selector switch. Sensitivity current is selectable using a JIS based 4.5x50 screwdriver. New model also includes a trip button.

● Front panel cutouts (partial list of main NF/NV models)

	NF		NV	
Former	NF50-CS~NF250-CS NF30-SS~NF250-SS NF50-HR, NF100-SH, NF250-SH	NF400-CS~NF800-CS NF400-SS~NF800-SS	NV50-CF~NV225-CF NV30-SF~NV225-SF	NV400-CF
New	NF50-CP~NF250-CP NF30-SP~NF250-SP NF50-HRP, NF100-HP, NF250-HP	NF400-CP~NF800-CP NF400-SP~NF800-SEP	NV50-CP~NV225-CP NV30-SP~NV225-SP	NV400-CP
Compatibility	Former cutout sizes can also be used on the front panel. The distance from the breaker base to the front panel differs from the former (see figure at right).		Compatibility is assured. The new 250A (225A) frame's breaker height is 18mm over than the former.	

● Dimensions (400AF 4-pole models)

● Both the overall module dimensions and bar terminal dimensions are altered greatly.

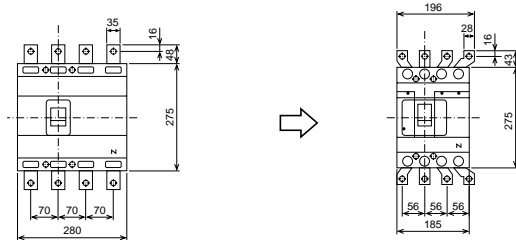

● Front panel cutouts (some as previous NF)

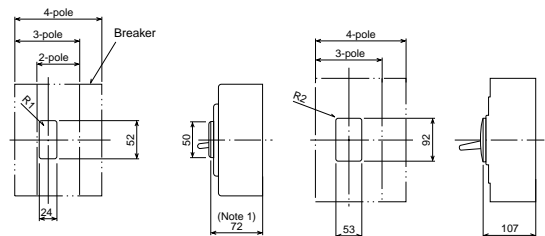

The cutout size is equal to breaker's window frame plus 1mm clearance.

● Connection parts (partial list of 3-pole C series models or equivalent)

Product name	Rear stud (B-ST)			Flush plate (FP)			Plug-in (PM)			
	Former	New	Compatibility	Former	New	Compatibility	Former	New	Compatibility	
Frame (A)	30/50/60	ST-05SS3 (screw stud)	ST-05SP3 (screw stud)	Compatible even though model numbers differ	FP-05SS3	FP-05SP3	Incompatible	PM-05SS3	PM05SP3	Incompatible
	100	ST-1SS3 (screw stud)	ST-1SP3 (bar stud)	Incompatible	FP-1SS3 (screw stud)	FP-1SP3 (bar stud)		PM-1SS3	PM-1SP3	
	250	ST-2SS3 (bar stud)	ST-2SP3 (bar stud)		FP-2SS3 (bar stud)	FP-2SP3 (bar stud)		PM-2SS3	PM-2SP3	
	400	ST-4SS3	ST-4SP3	●	FP-4SS3	FP-4SP3	×	PM-4SS3	PM-4SP3	●
	630	—	ST-6SP3	—	FP-6SS3	FP-6SP3	×	PM-6SS3	PM-6SP3	●
	800	—	ST-8SP3	—	FP-6SS3	FP-6SP3	×	PM-8SS3	PM-8SP3	●

● Rear studs for 100AF and NF50-HRP have changed from screw studs to bar studs (new).

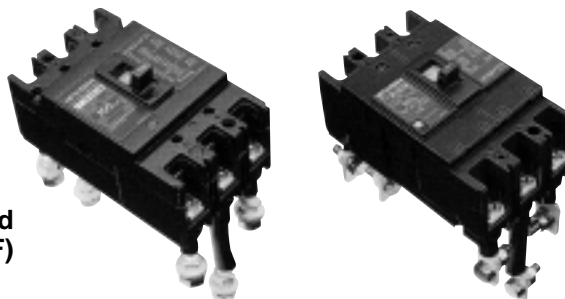

● Screw stud (former 100AF)

● Bar stud (new 100AF)

COMPARISON

OTHER CHANGES

Internal accessories

● Lead-wire terminal blocks

(Front/rear connection and plug-in types only; excludes P-LT types)

Type	Former	New
Lead-wire terminal block (LT)	●	—
Lead-wire terminal block (SLT)	●	●

- All new models use a vertical lead-wire terminal block (SLT).

● Lead-wire terminal block (LT)



● Vertical lead-wire terminal block (SLT)

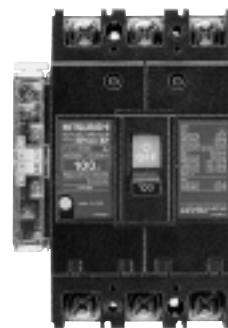

● Test lead (TBL) and Test button module (TBM) for ELCBs

	Former	New
TBL	●	●
TBM	—	●

The TBM has the following features:

- Standard with SLT.
- Uses a voltage-application system and offers same control sequence to that of SHT..
- Permits TBM parallel connection.
- Offers enhanced safety because it is isolated from the main circuit.

● Pre-Alarms

	Former	New (SSR output)	New (contact output)
Molded-case circuit breakers	Pre-alarm breakers (special specification)	The standard electronic MCCBs has solid-state relay (SSR) output pre-alarm as standard.	Optionally available as a model with a pre-alarm module in the standard electronic MCCBs.
Earth leakage circuit breakers	—	—	Optionally available as a model with a pre-alarm module in the standard electronic ELCBs.

External accessories

● Operating handles (F, S, SS types) (Main NF/NV models shown) (30-250AF)

Former			New			Compatibility
Breaker type	Parts number		Breaker type	Parts number		
NF30-SS, NF50-CS/SH NF60-CS/SH, NV30-SF NV50-CF/SF, NV60-CF/SF	F03SF, S03SF 142SF		NF30-SP, NF50-CP/HP NF60-CP/HP, NV30-SP NV50-CP/SP, NV60-CP/SP	F05SP, S05SP SS05SP		<ul style="list-style-type: none"> ● The basic external dimensions and cutout/drilling sizes are unchanged. ● Some new models have a different height from breaker base to the panel front compared to previous models. ● The former operating handles cannot be attached to the new breakers.
NF100-CS/SS	F10	S10 141SS	NF50-HRP, NF100-CP/SP/HP NV100-CP/SP	F1SP, S1SP SS1SP		
NF50-HR, NF100-SH	F11			F2SP, S2SP SS2SP		
NF160-SS, NF250-CS/SS	F20SF (NF)	S20 42SS	NF160-SP/HP NF250-CP/SP/HP NV225-CP/SP	F2SP, S2SP SS2SP		
NF160-SH, NF250-SH	F21					
NV225-CF/SF	F20SF (NV), S20(NV) 42SS (NV)					

- The new F and S-type handles show the tripping of a breaker even in ON-lock status. (Applies only when a padlock is used.)

● Enclosures (Shown for 3-pole C series models or equivalent)

Product name			Closed type (S)			Dustproof type (I)			Waterproof type (W)			
			Former	New	Compatibility	Former	New	Compatibility	Former	New	Compatibility	
AF	50•60	NF	NFS-05SS	NFS-05SP	ELCB models are compatible, even though part numbers differ. MCCB models are incompatible.	NFI-05SF	NFI-05SP	Incompatible	NFW-05SS	NFW-05SP	Incompatible	
		NV	NVS-05SF						NFW-1SS	NFW-1SP		
	100	NF	NFS-1SS	NFS-1SP		NFI-1SS	NFI-1SP		NFW-2SS	NFW-2SP		
		NV	NVS-1SF			NVI-2SS	NFI-2SP		NW-2SF	NFW-2SP		
	250	NF	—	NFS-2SP		Incompatible	NVI-2SF		NFI-2SP	NW-2SF		NFW-2SP
		NV	NVS-2SF									

● Terminal covers (Shown for 3-pole C series models or equivalent)

Product name		Large terminal cover (TC-L)		Small terminal cover (TC-S)		Transparent terminal cover (TTC)		Rear terminal cover (BTC)	
		Former	New	Former	New	Former	New	Former	New
AF	50•60	TCL-05SS3	TCL-05SP3	TCS-05SS3	TCS-05SP3	TTC-05SS3	TTC-05SP3	BTC-05SS3	BTC-05SP3
	100	TCL-1SS3	TCL-1SP3	TCS-1SS3	TCS-1SP3	TTC-1SS3	TTC-1SP3	BTC-1SS3	BTC-1SP3
	250	TCL-2SS3	TCL-2SP3	TCS-2SP3	TCS-2SP3	TTC-2SS3	TTC-2SP3	BTC-2SS3	BTC-2SP3

- 50AF and 60AF models are compatible, even though part numbers differ. (Note, however, that using an earlier terminal cover on a new breaker will block the internal accessories' leads from exiting on the load side.)
- 100AF and 250AF models are incompatible.

● Motor operation devices

- The new NF/NV C and S series breakers can accept electric operation devices.
- The electric operation device's performance and operation characteristics are unchanged.
- The external dimensions (shown for the main NF/NV models) are unchanged, except for height A in the figure.

Former		New	
Breaker type	A	Breaker type	A
NF100-CS/SS NV100-CF/SF	150	NF50-HRP NF100-CP/SP/HP NV100-CP/SP/HP	154
NF250-CS/SS NV225-CF/SF	170	NF250-CP/SP/HP NV225-CP/SP/HP	154
NF250-SH	187		

● Front connection type

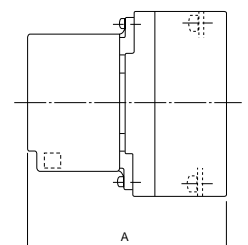

COMPARISON

OTHER CHANGES

External accessories

● Mechanical interlocks (MI) (Shown for surface mounting 2/3-pole C/S series or equivalent)

AF		Former			New		
		Part number	Standard P	t	Part number	Standard P	t
30, 50, 60 (not including NF50-HRP)	NF	MI-05SS3	94	2.3 (Standard)	MI-05SP3	120	Not required to be specified
	NV	MI-NV05SS3	120				
100 (including NF50-HRP)	NF	MI-1SS3	100				
	NV	MI-NV1SS3	120				
250	NF	MI-2SS3	115				
	NV	MI-NV2SS3	120				

- The new MIs have a different shape and install in a different position.
- The new MIs can be locked with a padlock (25mm).

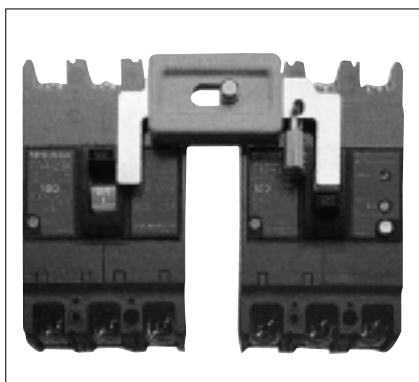

● Locks

Product name		Lock cover (LC)		Handle lock (HL)		Handle lock (HL-S)	
		Former	New	Former	New	Former	New
AF	30, 50, 60 (not including NF50-HRP)	LC03	LC-05SP	To be ordered as included in the breaker body	HL-05SP	To be ordered as included in the breaker body	HLS-05SP2 HLS-05SP
	100 (including NF50-HRP)		LC-1SP		HL-1SP		HLS-1SP2P HLS-1SP
	250	LC20	LC-1SP		HL-1SP		HLS-2SP

- All new handle locks can be installed by the customer.
(Use a 25mm padlock for HL models or 35mm padlock for HL-S.)
- New handle locks differ in shape from the former models and are thus incompatible.

● IEC 35mm rail-mounting adapters

AF	Number of poles	Former	New	Compatibility
30, 50, 60 (not including NF50-HRP)	2P	DIN-05SS2	DIN-05SP2	Compatible
	3P	DIN-05SS3	DIN-05SP3	
100 (including NF50-HRP)	2P	DIN-1SS2	DIN-1SP2	Incompatible
	3P	DIN-1SS3	DIN-1SP3	

● **External accessories (shown for 3-pole S series models or equivalent) (400-800AF)**

AF			400			630			800			
			Former	New	Compatibility	Former	New	Compatibility	Former	New	Compatibility	
Item	Operation handle #1	F	NF	F40	F4SP	X	F60	F6SP	X	F60	F6SP	X
			NV	F40NVCF	F4SPNV		24FA	F6SPNV		56FA	F6SPNV	
		S	NF	F40	S4SP	X	S40	S4SP	X	S40	S4SP	X
			NV	S41NV	—		—	—				
		SS	NF	61SS	SS4SP	X	61SS	SS4SP	X	61SS	SS4SP	X
			NV	60SS(NV)			25S			62		
	Enclosure	Dustproof (I)	NF	NFI-4SS	NFI-4SP	X	NFI-6SS	NFI-6SP	X	NFI-8SS	NFI-8SP	X
			NV	NVI-4SF			NVI-6SB			NVI-8SB		
		Waterproof (W)	NF	NFW-4SS	NFW-4SP	X	NFW-6SS	NFW-6SP	X	NFW-8SS	NFW-8SP	X
			NV	NVW-4SF			NVW-6SB			NVW-8SB		
	Terminal cover	Large (TC-L)	NF	TCL-4SS3	TCL-4SP3	X	TCL-6SS3	TCL-6SP3	X	TCL-6SS3	TCL-6SP3	X
			NV	—			TCL-6S3			TCL-8S3		
		Transparent (TTC)	NF	TTC-4SS3	TTC-4SP3	X	TTC-6SS3	TTC-6SP3	X	TTC-8S3	TTC-6SP3	X
			NV	—			TTC-600K			—		
		Rear (BTC)	NF	BTC-4SS3	BTC-4SP3	X	BTC-6SS3	BTC-6SP3	X	BTC-6SS3	BTC-6SP3	X
			NV	—			—			—		
	Mechanical interlock (MI)	NF	MI-4SS3	MI-4SP3	X	MI-8SS3	MI-6SP3	X	MI-8SS3	MI-6SP3	X	
		NV	—			—			—			
	Lock cover (LC)	NF	LC40	— *2	X	LC40	— *2	X	LC40	— *2	X	
		NV	—			—			—			
Handle lock	HL	NF	HL	HL-4SP	X	HL	HL-4SP	X	HL	HL-4SP	X	
		NV	—			—			—			
Operating handle(HT)	HL-S	NF	—	HLS-4SP	—	—	HLS-6SP	X	—	HLS-6SP	X	
		NV	—			—			—			
		NF	HT-4SS	HT-4SP	X	HT-4SS	HT-4SP	X	HT-4SS	HT-4SP	X	
		NV	HT-4SF			—			HT-10SS			

*1. While there is no change to the operating handle's dimensions and drilling plan, they are not suitable for use with the new breakers' operating handles.

*2. Please use HL.

COMPARISON

EXTERNAL DIMENSIONS

MCCBs, 3-Pole Models

(Figures in parentheses show former size where it differs from new size.)

Breaker type	New	NF30-SP NF50-CP, NF50-HP NF60-CP, NF60-HP MB30-SP MB50-CP, MB50-SP	NF100-CP, NF100-SP MB100-SP	NF50-HRP, NF100-HP
	Former	NF30-SS NF50-CS, NF50-SH NF60-CS, NF60-SH MB30-SS MB50-CS, MB50-SS	NF100-CS, NF100-SS MB100-SS	NF50-HR, NF100-SH
External dimensions				
Front connection type				
Front panel cutouts				
Rear connection type				
Flush type				

COMPARISON

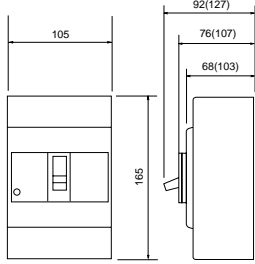
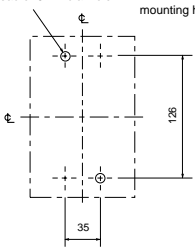
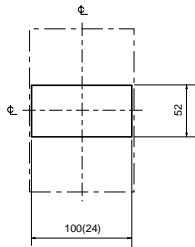
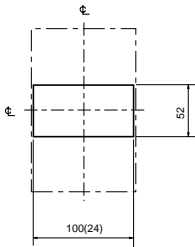
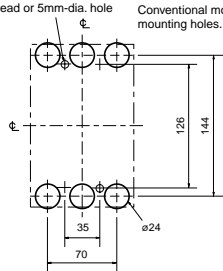
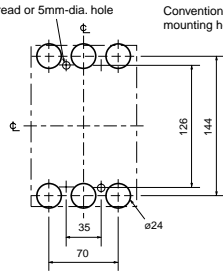
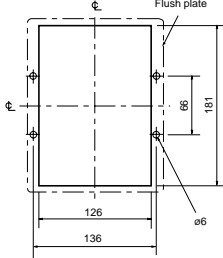
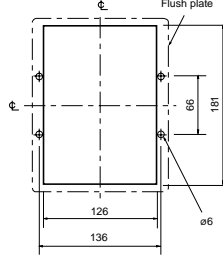
Breaker type	New	NF160-SP NF250-CP, NF250-SP MB225-SP	NF160-HP NF250-HP
	Former	NF160-SS NF250-CS, NF250-SS MB225-SS	NF160-SH NF250-SH
Front connection type	External dimensions		
		Drilling plan	<p>M4 thread or 5mm dia. hole</p> <p>Conventional models have four mounting holes.</p> 
Front panel cutouts			
Rear connection type	Cutout and drilling plan	<p>M4 thread or 5mm-dia. hole</p> <p>Conventional models have four mounting holes.</p> 	<p>M4 thread or 5mm-dia. hole</p> <p>Conventional models have four mounting holes.</p> 
Flush type	Cutout and drilling plan	<p>Flush plate</p> 	<p>Flush plate</p> 

COMPARISON

EXTERNAL DIMENSIONS

MCCBs, 3-pole models

(Figures in parentheses show former size where it differs from new size.)

Breaker type	New	NF400-CP NF400-SP, NF400-SEP NF400-HEP, NF400-REP	NF400-UEP	NF630-CP, NF630-SP, NF630-SEP NF630-HEP, NF630-REP NF800-CEP, NF800-SDP, NF800-SEP NF800-HEP, NF800-REP	NF630-UEP, NF800-UEP
	Former	NF400-CS NF400-SS, NF400-SE	NF400-UR	NF630-CS, NF630-SS, NF630-SE NF800-CS, NF800-SSD, NF800-SS	NF630-UR, NF800-UR
External dimensions					
Front connection type					
Drilling plan					
Front panel cutouts					
Rear connection type					
Cutout and drilling plan					
Flush type					

COMPARISON

COMPARISON

EXTERNAL DIMENSIONS

ELCBs, 3-pole models

(Figures in parentheses show former size where it differs from new size.)

Breaker type	New	NV400-CP, NV400-SP, NV400-SEP NV400-HEP, NV400-REP	NV630-CP, NV630-SP, NV630-SEP NV630-HEP	NV800-SEP, NV800-HEP
	Former	NV400-CF, NV400-CS, NV400-SF NV400-SS	NF600-CA, NV600-SB	NV800-SB
External dimensions				
Front connection type	*1 shows NV400-SS, NV400-CS.			
Drilling plan				
Front panel cutouts				
Rear connection type	Cutout and drilling plan 			
Mounting angle M8 screw or 10mm dia. hole	Cutout and drilling plan 			
	* () shows NV400-SS, NV400-CS.			

ELCBs, 4-pole models

Breaker type	New	NV400-SEP	NV630-SEP	
	Former	NV400-SB	NV600-SB	
External dimensions				
Front connection type	<p>Note: Max. size of front bar is 196mm.</p>			
Drilling plan				
Front panel cutouts				
Rear connection type	Cutout and drilling plan			
Mounting angle M8 screw or 10mm dia. hole	Cutout and drilling plan			

ORDERING INFORMATION

MCCBs and Switches

Type number	NF250-SP														
Number of poles	3P														
Rated current	200A														
Rated voltage	Specify DC for DC use														
Standards	Specify the applicable marine standards														
Connection method	<table border="1"> <tr><td>F</td><td>Front</td></tr> <tr><td>B</td><td>Rear</td></tr> <tr><td>FP</td><td>Flush plate</td></tr> <tr><td>PM</td><td>Plug-in</td></tr> </table>	F	Front	B	Rear	FP	Flush plate	PM	Plug-in						
F	Front														
B	Rear														
FP	Flush plate														
PM	Plug-in														
Internal accessories	<table border="1"> <tr><td>AL</td><td>Alarm switch</td></tr> <tr><td>AX</td><td>Auxiliary switch</td></tr> <tr><td>SHT</td><td>Shunt trip (specify rated coil voltage)</td></tr> <tr><td>UVT</td><td>Undervoltage trip (specify rated coil voltage)</td></tr> <tr><td>PAL</td><td>Pre-alarm module (for contact output)</td></tr> <tr><td>SLT</td><td>Lead-wire terminal block</td></tr> <tr><td>TI</td><td>Trip Indicator</td></tr> </table>	AL	Alarm switch	AX	Auxiliary switch	SHT	Shunt trip (specify rated coil voltage)	UVT	Undervoltage trip (specify rated coil voltage)	PAL	Pre-alarm module (for contact output)	SLT	Lead-wire terminal block	TI	Trip Indicator
AL	Alarm switch														
AX	Auxiliary switch														
SHT	Shunt trip (specify rated coil voltage)														
UVT	Undervoltage trip (specify rated coil voltage)														
PAL	Pre-alarm module (for contact output)														
SLT	Lead-wire terminal block														
TI	Trip Indicator														
External accessories	<table border="1"> <tr><td>NFM</td><td>Electric-operation device</td></tr> <tr><td>F/S/SS V/R</td><td>Operating handle</td></tr> <tr><td>S/I/W</td><td>Enclosure</td></tr> <tr><td>MI</td><td>Mechanical interlock</td></tr> <tr><td>TC-L/TC-S TTC/BTC</td><td>Terminal cover</td></tr> <tr><td>LC/HL HL-S</td><td>Handle lock</td></tr> <tr><td>CH</td><td>Card holder</td></tr> </table>	NFM	Electric-operation device	F/S/SS V/R	Operating handle	S/I/W	Enclosure	MI	Mechanical interlock	TC-L/TC-S TTC/BTC	Terminal cover	LC/HL HL-S	Handle lock	CH	Card holder
NFM	Electric-operation device														
F/S/SS V/R	Operating handle														
S/I/W	Enclosure														
MI	Mechanical interlock														
TC-L/TC-S TTC/BTC	Terminal cover														
LC/HL HL-S	Handle lock														
CH	Card holder														
Quantity	10														

ELCBs

Type number	NV225-CP																		
Number of poles	3P																		
Rated current	200A																		
Rated voltage	<table border="1"> <tr><td>High-speed type</td><td rowspan="2">230/400/440 VAC</td></tr> <tr><td>Time-delay type</td></tr> </table>	High-speed type	230/400/440 VAC	Time-delay type															
High-speed type	230/400/440 VAC																		
Time-delay type																			
Rated sensitivity current	<table border="1"> <tr><td>High-speed type</td><td rowspan="2">30/100/500 mA</td></tr> <tr><td>Time-delay type</td></tr> </table>	High-speed type	30/100/500 mA	Time-delay type															
High-speed type	30/100/500 mA																		
Time-delay type																			
Connection method	<table border="1"> <tr><td>F</td><td>Front</td></tr> <tr><td>B</td><td>Rear</td></tr> <tr><td>FP</td><td>Flush plate</td></tr> <tr><td>PM</td><td>Plug-in</td></tr> </table>	F	Front	B	Rear	FP	Flush plate	PM	Plug-in										
F	Front																		
B	Rear																		
FP	Flush plate																		
PM	Plug-in																		
Type of residual current protection	<table border="1"> <tr><td>High-speed type</td></tr> <tr><td>Time-delay type</td></tr> </table>	High-speed type	Time-delay type																
High-speed type																			
Time-delay type																			
Internal accessories	<table border="1"> <tr><td>AL</td><td>Alarm switch</td></tr> <tr><td>AX</td><td>Auxiliary switch</td></tr> <tr><td>MG</td><td>Insulation switch</td></tr> <tr><td>EAL</td><td>Earth-leakage alarm switch</td></tr> <tr><td>TBM</td><td>Test button module</td></tr> <tr><td>PAL</td><td>Pre-alarm module</td></tr> <tr><td>SLT</td><td>Lead-wire terminal block</td></tr> <tr><td>TBL</td><td>Test lead switch</td></tr> <tr><td>TI</td><td>Trip Indicator</td></tr> </table>	AL	Alarm switch	AX	Auxiliary switch	MG	Insulation switch	EAL	Earth-leakage alarm switch	TBM	Test button module	PAL	Pre-alarm module	SLT	Lead-wire terminal block	TBL	Test lead switch	TI	Trip Indicator
AL	Alarm switch																		
AX	Auxiliary switch																		
MG	Insulation switch																		
EAL	Earth-leakage alarm switch																		
TBM	Test button module																		
PAL	Pre-alarm module																		
SLT	Lead-wire terminal block																		
TBL	Test lead switch																		
TI	Trip Indicator																		
External accessories	<table border="1"> <tr><td>NFM</td><td>Electric-operation device</td></tr> <tr><td>F/S/SS V/R</td><td>Operating handle</td></tr> <tr><td>S/I/W</td><td>Enclosure</td></tr> <tr><td>MI</td><td>Mechanical interlock</td></tr> <tr><td>TC-L/TC-S TTC/BTC</td><td>Terminal cover</td></tr> <tr><td>LC/HL HL-S</td><td>Handle lock</td></tr> <tr><td>CH</td><td>Card holder</td></tr> </table>	NFM	Electric-operation device	F/S/SS V/R	Operating handle	S/I/W	Enclosure	MI	Mechanical interlock	TC-L/TC-S TTC/BTC	Terminal cover	LC/HL HL-S	Handle lock	CH	Card holder				
NFM	Electric-operation device																		
F/S/SS V/R	Operating handle																		
S/I/W	Enclosure																		
MI	Mechanical interlock																		
TC-L/TC-S TTC/BTC	Terminal cover																		
LC/HL HL-S	Handle lock																		
CH	Card holder																		
Quantity	10																		

□ = Please fill in boxes.

Country/Region	Company	Address	Telephone
U.K.	Mitsubishi Electric Europe B.V. UK-Branch.	Travellers Lane, Hatfield, Herts, AL10 8 XB, England, U.K.	44-1707-276,100
Ireland	Irish Branch.	Westage Business Park, Ballymount, Dublin 22, Ireland.	353-1-4505007
Germany	German Branch.	Gother Strasse 8, 40880 Ratingen, Germany.	49-2102-4860
Italy	Carpaneto 10090 CASCINE VICA-RIVOLI (TO)	Via Ferrero, 10-Ang. Pavia 6 Italy.	39-11-9590111
Spain	Spanish Branch (Barcelona).	Poligono Industrial "Can Magi", Calle Joan Buscallá 2-4, Apartado de Correos 420,08190 Sant Cugat del Valles, Barcelona, Spain.	34-93-565-3131
Sweden	Euro Energy Components AB	Box 10161 S-43422 Kungsbäcka	0300-51800
Norway	SCANELEC	5074 Godvik Leirvikasen 43B. Norway.	47-55-506000
Denmark	ELPEFA A/S	Geminivej 32, DK-2670 Greve, Denmark.	45-43-694369
Greece	Antonios Drepanias.S.A.	ANTONIOS DREPANIAS 52, ARKADIAS STR.GR 121 32, PERISTERI ATHENS GREECE.	30(1)5781599, 30(1)5781699
The Netherlands	R+H Technology BV.	3361 HJ Sliedrecht Industrieweg 30, Netherland.	31-104871521
Switzerland	Trielec A G	8201 Schaffhausen Mühentalstrasse 136, Switzerland	41-52-6258425
Belgium	Emac S.A.	1702 Groot-Bijgaarden Industrialaan 1, Belgium.	32-2-4810211
Poland	MPL Technology Sp zo.o.	30011 Krakow Ul. Wroclawska 53 Poland.	48-12-322885
Israel	Gino Industries LTD.	3, Ophir St. 32235 Haifa Israel.	972-4-8670656
Turkey	HEDEF	Balmumcu-Istanbul Barboros Bulv. İba Blokleri Gazi Umur P. So Turkey.	90-212-2754876
Slovenia	INEA	61230 Domzale Ljubljanska 80 Slovenia.	386-61-718000
South Africa	M.S.A.MANUFACTURING(PTY)LTD.	BRAMLEY 2018 JOHANNESBURG SOUTH AFRICA.	27-011-444-8080
Lebanon	COMPTOIR D'ELECTRICITE GENERALE-LIBAN	CEBACO CENTER-BLOCK A AUTOSTRAD DORA P.O. BOX: 90-1314BEIRUT-LEBANON.	961-1-240430
Saudi Arabia	CENTER OF ELECTRICAL GOODS	AL-NABHANIYA STREET-4TH CROSSING AL-HASSA ROAD P.O. BOX: 15955 RIYADH 11454-SAUDI ARABIA.	966-1-4770149
Egypt	CAIRO ELECTRICAL GROUP	9 ROSTOUM STREET GARDEN CITY, P.O. BOX: 165-11516, CAIRO EGYPT.	20-2-3561337
Kuwait	SALEM M AL-NISF ELECTRICAL CO.W.L.L.	P.O. Box 4784, Safat, 13048, Kuwait.	965-484-5660
China	SETSUYO AUSCHINA ELECTRIC CO. LTD.	Building of Innovation Center, Room No. 406A, Guiping Road Shanghai China	021-6485-6611
	RYODEN INTERNATIONAL LTD.	(Shanghai) Flat G,H,J,4/F, Jin Ming Building Block 2,8 Zun Yi Road South, Shanghai China	021-6275-8377
Hong Kong	Ryoden international Ltd.	10/F Manulife Tower 169 Electric Road North Point, Hong Kong.	28878870
Taiwan	Setsuyo Enterprise Co., Ltd.	8th Fl. NO.88 SEC. 6, Chung-Shan N Rd. Taipei, Taiwan	02-2381-3015
Korea	STC Techno Seoul Co., Ltd.(Setsuyo)	2 Fl. Dong Seo Game Channel Bldg., 660-11 Deungchon-Dong, Kangseo-Ku, Seoul, Korea	02-3664-8333
Singapore	mitsubishi electric asia pte ltd	307 ALEXANDRA ROAD #05-01/02 MITSUBISHI ELECTRIC BUILDING SINGAPORE 159943	65-473-2308
Indonesia	P.T.SAHABAT INDONESIA.	JL Muara Karang Selatan Blok A/Utara No.1 kav.11 NO.1 P.O. Box 5045/Jakarta/11050. Jakarta Indonesia.	021-6621780
Philippines	EDISON ELECTRIC INTEGRATED INC.	24th Fl. Galleria Corporate Center Edsa Cr, Ortigas Ave. Quezon City, Metro Manila, Philippines.	02-643-8691
Thailand	UNITED TRADING & IMPORT CO. LTD.	77/12 BAMRUNG MUANG ROAD, KLONG MAHANAK, POMPRAW, BANGKOK 10100	02-223-4200-3
Pakistan	Prince Electric Co.	16 Brandreth Road Lahore 54000, Pakistan.	042-7654342
Vietnam	Sa Giang Techno co., Ltd.(Setsuyo)	207/4 NGUYEN VAN THU ST., DA KAO WARD, DIST 1 HCMC, VIETNAM	848-821-5450
Lao PDR	SOCIETE LAO IMPORT-EXPORT	43-47 LANE XANG ROAD P.O. BOX 2789 VT VIENTIANE LAO PDR.	21-215043, 21-215110
Myanmar	PEACE MYANMAR ELECTRIC CO., LTD.	NO. 216, BO AUNG GYAW STREET, BOTATAUNG 11161, YANGON, MYANMAR.	951-295426
Nepal	Watt & Volt House Co., Ltd.	KHA 2-65, Volt House Dilli Bazar Post Box: 2108, kathmandu, Nepal	977-1-411330
Australia	348 VICTORIA ROAD.	P.O. BOX: 11, RYDALMERE NSW 2166.	612-9684, 7245
New Zealand	Melco Sales (N.Z.) Ltd.	1 Parliament Street Lower Hutt, New Zealand.	644-569-7350
Colombia	Proelectrico LTDA.	Carrera 43G No. 27-12 P.O. Box 4346 Medellin. COLOMBIA	(4) 2623038
Chile	RHONA S.A.	Vte. Agua Santa 4211 Casilla (P.O. Box) 30-D Viña Del Mar, Chile	(32)-611294
Uruguay	Fierro Vignoli S.A.	Avda. 1274 Montevideo, Uruguay.	(2) 921230
Peru	I.T.E.	Ingenieros s.a. Paseo de la Republica 3573 Lima 27, Peru.	(1) 221-2710
Venezuela	ADESCO C.A.	Calle 7,EDF.LOS ROBLES.LOCALES CYD URBANIZACION LA URBINA -EDO.MIRANDA P.O. BOX 78034 CARACAS 1074A	(2) 241-7634

Safety Tips : Be sure to read the instruction manual fully before using this product.

 **MITSUBISHI ELECTRIC CORPORATION**
HEAD OFFICE: MITSUBISHI DENKI BLDG., MARUNOUCHI, TOKYO 100-8310. TELEX: J24532 CABLE: MELCO TOKYO