

User Guide
6650-2251



ODW-632

Fibre Optic Modem



Industrial Converter
RS-485 to Fibre Optic Link
Repeater, line and redundant ring

www.westermo.com

Legal information

The contents of this document are provided "as is". Except as required by applicable law, no warranties of any kind, either express or implied, including, but not limited to, the implied warranties of merchantability and fitness for a particular purpose, are made in relation to the accuracy and reliability or contents of this document. Westermo reserves the right to revise this document or withdraw it at any time without prior notice.

Under no circumstances shall Westermo be responsible for any loss of data or income or any special, incidental, and consequential or indirect damages howsoever caused.

More information about Westermo can be found at the following Internet address:
<http://www.westermo.com>

Safety



Before installation:

Read this manual completely and gather all information on the unit. Make sure that you understand it fully. Check that your application does not exceed the safe operating specifications for this unit.

This unit should only be installed by qualified personnel.

This unit should be built-in to an apparatus cabinet, or similar, where access is restricted to service personnel only.

The power supply wiring must be sufficiently fused, and if necessary it must be possible to disconnect manually from the power supply. Ensure compliance to national installation regulations.

This unit uses convection cooling. To avoid obstructing the airflow around the unit, follow the spacing recommendations (see Cooling section).



Before mounting, using or removing this unit:

Prevent access to hazardous voltages by disconnecting the unit from the power supply.

Warning! Do not open a connected unit. Hazardous voltages may occur within this unit when connected to a power supply.



Class 1 Laser Product

This unit is designed to meet the Class 1 Laser regulations. However, the user is warned not to look directly into fibre optical port or any connected fibre.

Care recommendations

Follow the care recommendations below to maintain full operation of the unit and to fulfil the warranty obligations.

This unit must not be operated with covers or lids removed.

Do not attempt to disassemble the unit. There are no user serviceable parts inside.

Do not drop, knock or shake the unit. Rough handling beyond the specification may cause damage to internal circuit boards.

Do not use harsh chemicals, cleaning solvents or strong detergents to clean the unit.

Do not paint the unit. Paint can clog the unit and prevent proper operation.

Do not expose the unit to any kind of liquids (rain, beverages, etc).

The unit is not waterproof. Keep the unit within the specified humidity levels.

Do not use or store the unit in dusty, dirty areas. Connectors as well as other mechanical parts may be damaged.

If the unit is not working properly, contact the place of purchase, nearest Westermo distributor office, or Westermo Tech support.

Fibre connectors are supplied with plugs to avoid contamination inside the optical port.

The plug should be fitted when no optical fibre is inserted in the connector, e.g. during storage, service or transportation.

Note. Fibre Optic Handling

Fibre optic equipment requires careful handling as the fibre components are very sensitive to dust and dirt. If the fibre is disconnected from the modem, the protective plug on the transmitter/receiver must be replaced. The protective plug must be kept on during transportation. The fibre optic cable must also be protected in the same way. If this recommendation is not followed, it can jeopardise the warranty.

Cleaning of the optical connectors

In the event of contamination, the optical connectors should be cleaned by using forced nitrogen and some kind of cleaning stick.

Recommended cleaning fluids:

- Methyl-, ethyl-, isopropyl- or isobutyl-alcohol
- Hexane
- Naphtha

Maintenance

No maintenance is required, as long as the unit is used as intended within the specified conditions.

Agency approvals and standards compliance

Type	Approval / Compliance
EMC	EN 61000-6-2, Immunity industrial environments
	EN 55024, Immunity IT equipment
	EN 61000-6-3, Emission residential environments
	FCC part 15 Class A
	EN 50121-4, Railway signalling and telecommunications apparatus
	IEC 62236-4, Railway signalling and telecommunications apparatus
Safety	EN 60950-1, IT equipment

NOTE: This equipment has been tested and found to comply with the limits for a Class A digital device, pursuant to Part 15 of the FCC Rules. These limits are designed to provide reasonable protection against harmful interference when the equipment is operated in a commercial environment. This equipment generates, uses, and can radiate radio frequency energy and, if not installed and used in accordance with the instruction manual, may cause harmful interference to radio communications. Operation of this equipment in a residential area is likely to cause harmful interference in which case the user will be required to correct the interference at his own expense.

Declaration of Conformity



Westermo Teleindustri AB

Declaration of conformity

The manufacturer Westermo Teleindustri AB
SE-640 40 Stora Sundry, Sweden

Herewith declares that the product(s)

Type of product	Model	Art no	Installation manual
Industrial Converter, PROFIBUS DP to fibre optic link	ODW-611	3650-xxxx	6650-2201
	ODW-612	3650-xxxx	6650-2211
Industrial Converter, RS-232 to fibre optic link	ODW-621	3650-xxxx	6650-2222
	ODW-622	3650-xxxx	6650-2232
Industrial Converter, RS-485 to fibre optic link	ODW-631	3650-xxxx	6650-2241
	ODW-632	3650-xxxx	6650-2251

is in conformity with the following EC directive(s).

No	Short name
89/336/EEG	Electromagnetic Compatibility (EMC)

References of standards applied for this EC declaration of conformity.

No	Title	Issue
EN 61000-6-2	Immunity for industrial environments	2 (2001)
EN 55024	Information technology equipment – Immunity	1 (1998)
EN 61000-6-3	Emission standard for residential, commercial and light-industrial environments	1 (2001)

Herewith declares that product(s) listed above is in conformity with

No	Title	Issue
FCC part 15	Radio frequency devices	2003

Hans Levin
Technical Manager
10th April 2008

Postaddress/Postal address
S-640 40 Stora Sundry
Sweden

Tel.
016-428000
Int+46 16428000

Telefax
016-428001
Int+46 16428001

Postgiro
52 72 79-4

Bankgiro
5671-5550

Org.nr/
Corp. identity number
556361-2604

Registered of
Eskilstuna

Type tests and environmental conditions

Electromagnetic Compatibility			
Phenomena	Test	Description	Level
ESD	EN 61000-4-2	Enclosure contact	± 6 kV
		Enclosure air	± 8 kV
RF field AM modulated	IEC 61000-4-3	Enclosure	20V/m 80% AM (1 kHz), 80 – 2000 MHz
RF field 900 MHz	ENV 50204	Enclosure	20V/m pulse modulated 200 Hz, 900 ± 5 MHz
Fast transient	EN 61000-4-4	Signal ports	± 2 kV
		Power ports	± 2 kV
Surge	EN 61000-4-5	Signal ports unbalanced	± 2 kV line to earth, ± 2 kV line to line
		Signal ports balanced	± 2 kV line to earth, ± 1 kV line to line
		Power ports	± 2 kV line to earth, ± 2 kV line to line
RF conducted	EN 61000-4-6	Signal ports	10V 80% AM (1 kHz), 0.15 – 80 MHz
		Power ports	10V 80% AM (1 kHz), 0.15 – 80 MHz
Power frequency magnetic field	EN 61000-4-8	Enclosure	100 A/m, 50 Hz, 16.7 Hz & 0 Hz
Pulse Magnetic field	EN 61000-4-9	Enclosure	300 A/m, 6.4 / 16 µs pulse
Voltage dips and interruption	EN 61000-4-11	AC power ports	10 & 5 000 ms, interruption 10 & 500 ms, 30% reduction 100 & 1 000 ms, 60% reduction
Mains freq. 50 Hz	EN 61000-4-16	Signal ports	100 V 50 Hz line to earth
Mains freq. 50 Hz	SS 436 15 03	Signal ports	250 V 50 Hz line to line
Voltage dips and interruption	EN 61000-4-29	DC power ports	10 & 100 ms, interruption 10 ms, 30% reduction 10 ms, 60% reduction +20% above & -20% below rated voltage
Radiated emission	EN 55022	Enclosure	Class B
	FCC part 15		Class A
Conducted emission	EN 55022	AC power ports	Class B
	FCC part 15	AC power ports	Class A
	EN 55022	DC power ports	Class B
Dielectric strength	EN 60950	Signal port to all other isolated ports	2 kVrms 50 Hz 1min
		Power port to other isolated ports	3 kVrms 50 Hz 1min 2 kVrms 50 Hz 1min (@ rated power < 60V)
Environmental			
Temperature		Operating	-40 to +60°C
		Storage & Transport	-40 to +70°C
Humidity		Operating	5 to 95% relative humidity
		Storage & Transport	5 to 95% relative humidity
Altitude		Operating	2 000 m / 70 kPa
Service life		Operating	10 year
Vibration	IEC 60068-2-6	Operating	7.5 mm, 5 – 8 Hz 2 g, 8 – 500 Hz
Shock	IEC 60068-2-27	Operating	15 g, 11 ms
Packaging			
Enclosure	UL 94	PC / ABS	Flammability class V-1
Dimension W x H x D			35 x 121 x 119 mm
Weight			0.26 kg
Degree of protection			IP 21
Cooling	IEC 529	Enclosure	Convection
Mounting			Horizontal on 35 mm DIN-rail

Description

This ODW-632 is a fibre optic modem used for redundant ring and multidrop applications. It acts as a converter between a serial port and a fibre optical link. The maximum distance of the fibre link depends on selected transceiver and fibre type. Distance up to 80 km (50 miles) is available.

The ODW-632 is designed for harsh out-door usage, in industrial, road or railway installations.

Data will be sent transparently over the fibre optical link via the serial interface RS-422/485.

- ⌘ Converter serial interface – optical fibre.
- ⌘ Redundant ring alternatively multidrop communication via fibre optical network.
- ⌘ Serial interface Asynchronous or Synchronous mode.
- ⌘ LC-2 Multimode LC connectors, 5 km (3.1 miles).
- ⌘ LC-15 Singlemode LC connectors, 15 km (9.3 miles).
- ⌘ LC-40 Singlemode LC connectors, 40 km (24.9 miles).
- ⌘ LC-80 Singlemode LC connectors, 80 km (50 miles).
- ⌘ Bi-di Multimode LC connectors, 5 km (3.1miles).
- ⌘ Bi-di Singlemode LC connectors, 20 km (12.5 miles).
- ⌘ Bi-di Singlemode LC connectors, 40 km (24.9 miles).
- ⌘ Bi-di Singlemode LC connectors, 60 km (37.3 miles).
- ⌘ Design for harsh environments.
- ⌘ Re-timing.
- ⌘ Redundant DC or AC power supply, 2 kVAC galvanic isolated to other ports.
- ⌘ Status interface for fault indication.
- ⌘ Small Form Factor Pluggable (SFP) transceivers.
- ⌘ 4 positions detachable screw terminal.

- ⌘ RS-485 interface.
- ⌘ Data rate up to 1.5 Mbit/s.

Functional description

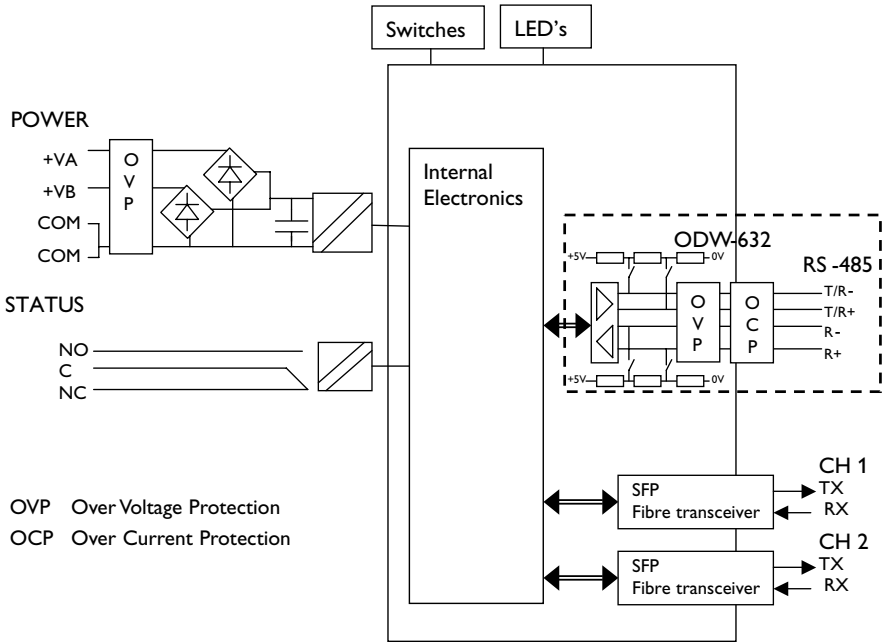

OVP Over Voltage Protection
 OCP Over Current Protection

Converter serial interface – optical fibre

ODW-632 is a fibre optic modem that converts between electrical RS-485 and a fibre optical link.

ODW-632 can also be used to convert from RS-232 to RS-485 by using a ODW-622 in the same link as ODW-632.

Repeater – optical fibre links

ODW-632 is a fibre optic repeater that repeats received data from one fibre link out to the other link. This is useful e.g. for long distance communication, where electromagnetic interference may occur or when isolation of the electrical network is needed. The maximum optical fibre distance depends on selected fibre transceiver and fibre type. Distances up to 80 km (50 miles) are available.

Data rate up to 1.5 Mbit/s

ODW-632 converts data using rates from 300 bit/s up to 1.5 Mbit/s. Retiming of the data ensures that the correct signal form is transmitted from the ODW-632 converter.

Designed for harsh environments, such as industrial, road and railway applications

ODW-632 complies with standards for industrial environments and railway signalling and telecommunications apparatus. Additionally, the wide climatic range of the ODW-632 allows it to be installed in out-door cabinets without any additional measures, such as heating, etc.

Redundant ring via fibre optical network

Under normal operation the serial data is sent over ring A. Should a fault be detected on the fibre ring then the data will be carried on rings A and B.

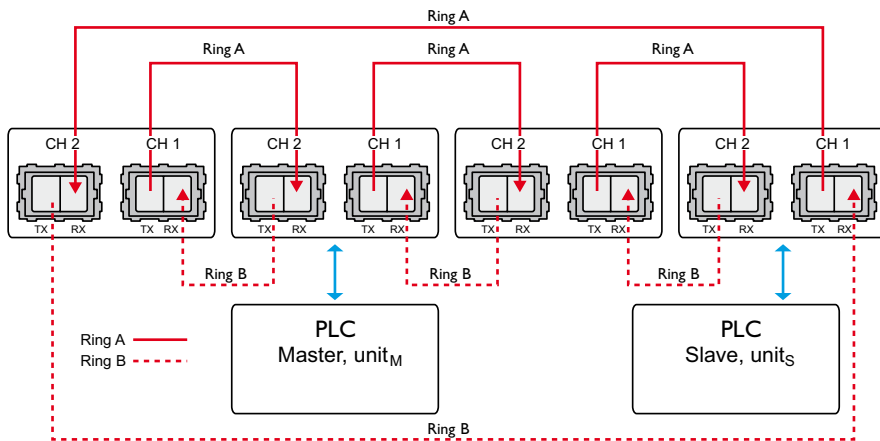

Note! Ring A start up at TX (channel 1) and ring B ends up at RX (channel 1).

⌘ Normal operation, data exchange between serial master and slave.

- ODW-632 unit connected to the PLC-master receives serial data at the electrical port, it converts and transfers this master frame via the fibre ring A. At this unit the repeating of transferred frames is stopped until this transferred master frame has returned via ring A. This master frame will be repeated through fibre ring A by all the other units. Each of these units will also convert the master frame to serial data and send it via the electrical port.
- ODW-632 unit to which the addressed Slave is connected, receives serial data from the Slave. This unit converts slave data and transfers the slave frame via ring A. The repeating of transferred frames is stopped until this transferred slave frame has returned via ring A.
- When the “first” ODW-632 unit receives the master frame (the same frame that has been transmitted by this unit), or after a timeout, data conversion at will be allowed again. The received slave frame will be converted and transmitted at the electrical port.

- When the ODW-632 unit connected to the PLC slave receives the slave frame (the same frame that has been transmitted by this unit), or after a timeout, data conversion at this unit will be allowed again.

⚙ Behaviour under faulty conditions

- Elapsed time from any kind of failure at the fibre optic network until data exchange after a corrective action depends on total length of fibre ring.
This is typically 10–20 ms (local unit). During that time, the transferred data frames should be seen as corrupted or missed.

Note: Be ware of that full duplex will not work in redundant ring.

Failure	Indications
Fibre interruption ring A, TX	On: FL R
Fibre interruption ring A, RX	On: FL L
Fibre interruption ring A, RX & TX	On FL L
Fibre interruption ring B, TX	On: FL R
Fibre interruption ring B, RX	On: FL L
Fibre interruption ring B, RX & TX	On: FL L
Fibre interruption ring A and B (e.g. CH1 or CH2 both TX & RX)	On: FL L &/or FL R
Low power on the receiver (May indicate bad fibre)	FLL flicker

* Regarding functionality see chapter “multidrop application”

⚙ Recovery from faulty status

- ODW-632 will automatically recover to the previous operating status when a failure disappears. This involves recovery from multi drop application to Redundant ring A/B when ring is up and running and recovery from Ring B to Redundant ring A when the ring is up and running.
- The time to recover from the failure status depends on total length of fibre ring.
This is typically 10–20 ms. During that time the transferred data frames should be seen as corrupted or missed.

Serial data transfer can be set in two modes:

Synchronous mode: Transfer special protocols such as Manchester coded protocol. See special switch settings on page 22.

Asynchronous mode: Data will be sent over the fibre optic network when a startbit has been identified. The data rate and number of data bits should be set by DIP-switches. the turning time (from sending serial RS-485 data until changing to receive mode) is automatically calculated from the DIP-switch setting.

Multidrop via fibre optical network

The data is transferred via the fibre optic network to the serial ports of all units. If ODW-632 is connected to two optical fibre links (mid unit) converted data will be transmitted in both directions, via both CH 1 and CH 2. With only one optical fibre link (end unit) converted data will be transmitted in one direction, via CH 1 only. Data received from one ODW-632 optical fibre port will be repeated through the other optical fibre port and it will also convert the frame to serial data.

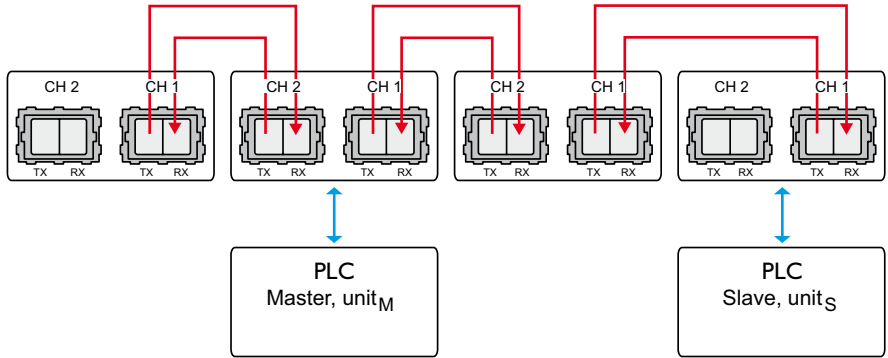

Optical fibre link functionality and status indication

At power on, all LED's will be active during an initiation sequence followed by an automatic initiation of the optical fibre links. The alarm will be set until the fibre optical links are in operation and ready to transfer serial data.

Data frames are transferred over the fibre optic links as long as the links are in operation and the data rate has been detected.

When any of the fibre optic links is out of operation, this will be indicated by a local alarm, and this will set the alarm output. It will also send a remote alarm via the other link, if possible. When the link returns to operations mode, the alarm will reset automatically.

RS-485 interface

A 4 position detachable screw terminal that can handle full duplex data rates up to 1.5 Mbit/s and can be set to either 2- or 4-wire RS-485 system.

When 4-wire RS-485 is selected, the terminals T/R+ and T/R- will always be set to transmit and terminals R+ and R- will always receive data.

Manchester coded protocol can be transferred with Synchronous mode.

Redundant power supply, galvanic isolated (2 kVAC) to other ports

ODW-632 should be supplied with safety extra low voltage (SELV). It is designed to operate permanently over a wide input range and provided with two independent inputs, allowing redundancy should either supply fail.

Single- or multimode LC fibre connectors

ODW-632 use Small Form Factor Pluggable (SFP) transceivers that are in compliance with the Multi-Sourcing Agreement (MSA). This means that a wide range of different fibre transceivers and connectors can be used.

Status interface

This port enables supervision of fibre optic link status by a relay with both normally open and closed contacts.

The status will be set if:

- Local or remote of fibre link errors exist.
- The unit is out of service, e.g. no power supply.

System delay in an optical network

Data exchange between a serial master and slave via ODW-632 fibre optic link, will be delayed due to the length of the optical fibre and the signal processing within the ODW-632. The signal processing delay is dependent on the data rate, and the fibre delay is dependent on the total length of the optical fibre.

There is no limitation of the total length of optical fibre for Multi-drop applications. In Redundant ring applications the data transfer time in a ring is limited to 10 milliseconds. This means the total length of the optical fibre ring is about 2 000 km, excluding the 1 microsecond delay at each optical repeater unit.

The additional time resulting from the optical fibre and ODW-632 is the Overall system delay. The Redundant ring and Multidrop application Overall system delays differ, see below.

Item	Functions	Delay
1	Fibre: Optical fibre length delay (typical)	5 μ s/km
2	Converter electrical to fibre: Signal processing	0.6 μ s (synchronous mode) 1 $t_{\text{Bit}} + 0.6 \mu$ s (asynchronous mode)
3	Converter fibre to electrical: Signal processing	0.6 μ s

Note $t_{\text{bit}} = 1 / \text{Baud rate}$ (Baud rate in bit/s)

⚡ Redundant ring, one data exchange.

- The data exchange between master and slave via ODW-632 fibre optic link will run one direction through all units of the ring. The system delay is calculated by summing the following:
 1. Fibre: The total optical fibre ring length delay.
 2. Optical repeaters: The optical repeater delay x Number of optical repeaters (excluding the ODW-632 units connected to a master and addressed slave).
 3. Converter electrical to fibre: Signal processing delay x 2 (ODW-632 units connected to serial master and addressed slave).
 4. Converter fibre to electrical: Signal processing delay x 2 (ODW-632 units connected to a master and addressed slave).

Multi drop, one data exchange.

- The data exchange between a master and slave via ODW-632 fibre optic link will run from the ODW-632 units connected to a master to the slave and the same way back to the master. The system delay is calculated by summing the following:
 1. Fibre: The optical fibre length a master to addressed slave delay x 2.
 2. Optical repeaters: The optical repeater delay * Number of optical repeaters (excluding the ODW-632 units connected to a master and addressed slave) x 2.
 3. Converter electrical to fibre: Signal processing delay x 2 (ODW-632 units connected to a master and addressed slave).
 4. Converter fibre to electrical: Signal processing delay x 2 (ODW-632 units connected to a master and addressed slave).

Example

- Redundant ring, one data exchange between master and one slave.
One a master and 11 slaves with data rate 9600 bit/s dependent mode. 12 ODW-632 units with a total fibre length of 40 km. A data exchange between master and one slave.
1. Fibre: The total optical fibre ring length delay.
 $40 \times 5 \mu\text{s} = 200 \mu\text{s}$
 2. Optical repeaters:
The optical repeater delay \times Number of optical repeaters
(excluded the two units connected to PLC master and slave).
 $10 \times 3.0 \mu\text{s} = 30 \mu\text{s}$
 3. Converter electrical to fibre:
Signal processing delay $\times 2$
(ODW-632 units connected to a master and addressed slave).
 $(1 t_{\text{bit}} + 0.6 \mu\text{s}) \times 2 = (105 \mu\text{s} + 0.6 \mu\text{s}) \times 2 = 211 \mu\text{s}$
 4. Converter fibre to electrical:
Signal processing delay $\times 2$
(units connected to PLC master and slave).
 $0.6 \mu\text{s} \times 2 = 1.2 \mu\text{s}$
 5. The system delay is calculated by summing the delays in item 1 to 4 above:
 $200 \mu\text{s} + 30 \mu\text{s} + 211 \mu\text{s} + 1.2 \mu\text{s} = 442 \mu\text{s}$

Interface specifications

Power	
Rated voltage	12 to 48 VDC 24 VAC
Operating voltage	10 to 60 VDC 20 to 30 VAC
Rated current	400 mA @ 12 V 250 mA @ 24 V 100 mA @ 48 V
Rated frequency	DC: – AC: 48 to 62 Hz
Inrush current I _{2t}	0.2 A ² s
Startup current*	1.0 A _{peak}
Polarity	Reverse polarity protected
Redundant power input	Yes
Isolation to	RS-422/485 and Status port
Connection	Detachable screw terminal
Connector size	0.2 – 2.5 mm ² (AWG 24 – 12)
Shielded cable	Not required

* External supply current capability for proper startup

RS-422/485	
Electrical specification	EIA RS-485, 2-wire or 4-wire twisted pair
Data rate	300 bit/s – 1.5 Mbit/s
Data format	9 – 12 bits
Protocol	Start-bit followed by 8-11 bits
Retiming	Yes
Turning time (2-wire RS-485)	One t _{bit} t _{bit} = 1 / Baud rate (Baud rate in bit/s)
Transmission range	< 1200 m, depending on data rate and cable type (EIA RS-485)
Settings	120 Ω termination and failsafe biasing 680 Ω
Protection	Installation Fault Tolerant (up to ±60 V)
Isolation to	Status and Power port
Connection	Detachable screw terminal
Connector size	0.2 – 2.5 mm ² (AWG 24 – 12)
Shielded cable	Not required

Status	
Port type	Signal relay, changeover contacts
Rated voltage	Up to 48 VDC
Operating voltage	Up to 60 VDC
Contact rating	500 mA @ 48 VDC
Contact resistance	< 50 mΩ
Isolation to	RS-422/485 and Power port
Connection	Detachable screw terminal
Connector size	0.2 – 2.5 mm ² (AWG 24 – 12)
Shielded cable	Not required

Optical Power Budget

The allowed link length is calculated from the optical power budget (OPB), the available optical power for a fibre-optic link, and the attenuation of the fibre, comprising losses due to in-line connectors, splices, optical switches and a margin for link ageing (typical 1.5 dB for 1300 nm).

The worst-case optical power budget (OPB) in dB for a fibre-optic link is determined by the difference between the transmitter's output optical power (min) and the receiver input sensitivity (max).

FX (Fibre)	SM-LC80	SM-LC40	SM-LC15	MM-LC2
Fibre connector	LC duplex	LC duplex	LC duplex	LC duplex
Fibre type	Singlemode 9/125 µm	Singlemode 9/125 µm	Singlemode 9/125 µm	Multimode, 62.5/125 and 50/125 µm
Wavelength	1550 nm	1310 nm	1310 nm	1310 nm
Transmitter Output optical power min/max	-5/0 dBm**	-5/0 dBm**	-15/-8 dBm**	-20/-14 dBm*
Receiver Input sensitivity, max	-34 dBm	-34 dBm	-31 dBm	-31 dBm
Receiver Input optical power, max	-5 dBm***	-3 dBm***	-8 dBm	-8 dBm
Optical power budget, worst-case	29 dB	29 dB	16 dB	11 dB
Transceiver type	Small Form Factor Pluggable (SFP) Multi-Sourcing Agreement (MSA) compliant			
Laser class	Class 1, IEC 825-1 Accessible Emission Limit (AEL)			

FX (Fibre)	Bi-di LC-60	Bi-di LC-40	Bi-di LC-20	Bi-di MM LC-2
Fibre connector	LC Simplex	LC Simplex	LC Simplex	LC Simplex
Fibre type	Singlemode 9/125 µm	Singlemode 9/125 µm	Singlemode 9/125 µm	Multimode 62.5/125 and 50/125 µm
Wavelength nm, connector 1	Tx 1310, rx	Tx 1310, rx	Tx1310, rx	Tx 1310, rx
Wavelength nm, connector 2	1550 Tx 1550, rx 1310	1550 Tx 1550, rx 1310	1550 TX 1550, rx 1310	1550 Tx 1550, rx 1310
Transmitter Output optical power min/max	-5/0 dBm **	-8/0 dBm **	-10/0 dBm **	-10/-8 dBm *
Receiver Input sensitivity, max	-34 dBm	-34 dBm	-28 dBm	-28 dBm
Receiver Input optical power, max	0 dBm***	0 dBm***	0 dBm	-0 dBm
Optical power budget, worst-case	29 dB	26 dB	18 dB	18 dB
Transceiver type	Small Form Factor Pluggable (SFP) Multi-Sourcing Agreement (MSA) compliant			
Laser class	Class 1, IEC 825-1 Accessible Emission Limit (AEL)			

* Output power is power coupled into a 62.5/125 µm multimode fibre

** Output power is power coupled into a 9/125 µm singlemode fibre

*** The optical power should be reduced by at least 5 dB (SM-LC80 and Bi-di LC-60) or 3dB (SM-LC-40 and Bi-di LC-40) between the optical output and input.

Location of Interface ports, LED's and DIP-switches

ODW-632

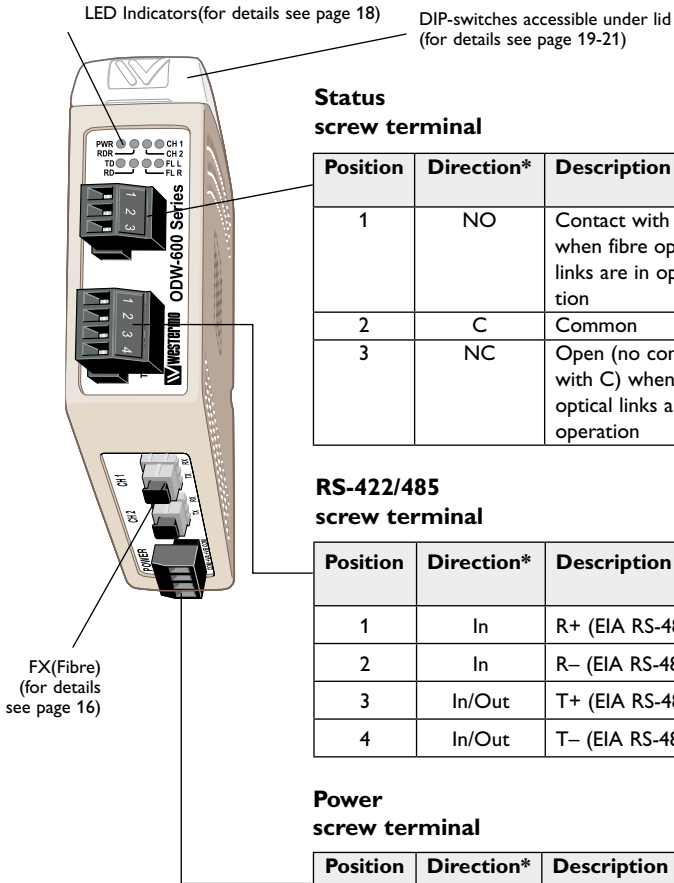

Status screw terminal

Position	Direction*	Description	Product marking
1	NO	Contact with C when fibre optical links are in operation	NO
2	C	Common	C
3	NC	Open (no contact with C) when fibre optical links are in operation	NC

RS-422/485 screw terminal

Position	Direction*	Description	Product marking
1	In	R+ (EIA RS-485 A')	R+
2	In	R- (EIA RS-485 B')	R-
3	In/Out	T+ (EIA RS-485 A)	T/R+
4	In/Out	T- (EIA RS-485 B)	T/R-

Power screw terminal

Position	Direction*	Description	Product marking
1	In	Common voltage	COM
2	In	Voltage A	+VA
3	In	Voltage B	+VB
4	In	Common voltage	COM

* Direction relative this unit

LED indicators

LED	Status	Description
PWR Power	ON	In service (power)
	Flashing	Fault condition
	OFF	Out of service
RDR	ON	Redundant ring mode
	OFF	Multidrop mode
CH 2	ON	Fiber link at port CH 2 in operation. Data can be transmitted
	OFF	Fiber link at port CH 2 out of operation
CH 1	ON	Fibre link at port CH 1 in operation. Data can be transmitted
	OFF	Fibre link at port CH 1 out of operation
TD Serial data Receive	Flashing	Receive accepted data on the serial port. Data will be transmitted to the fibre link
	OFF	–
RD Fibre link data Receive	Flashing	Received data on the fibre link. This frame is transmitted to the serial port.
	OFF	–
FL R (Red) Failure Link Remote	ON	Remote fibre link failure. A fibre link is out of operation at any other unit of the optical network
	OFF	All fibre links are in operation at all other units in the fibre optical network
FL L (Red) Failure Link Local	ON	Local fibre link failure. This unit has identified a fibre link failure
	OFF	Fibre link of this unit is in operation

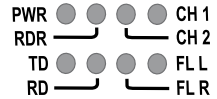

Configuration

All needed configurations and parameter settings are done by the DIP-switches, located under the top lid of the ODW-632.

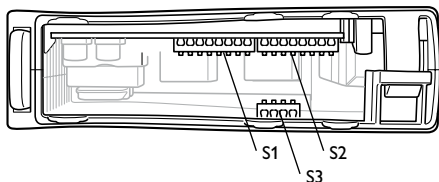

DIP-switch settings

Before DIP-switch settings:

Prevent damage to internal electronics from electrostatic discharges (ESD) by discharging your body to a grounding point (e.g. use of wrist strap)

Note: Disconnect power before DIP-switch settings.

S1 DIP-switch, asynchronous mode



RS-485 2-wire



57.6 kbit/s



RS-485 4-wire



115.2 kbit/s



300 bit/s

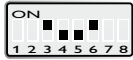

125 kbit/s



1 200 bit/s



187.5 kbit/s



2 400 bit/s



230.4 kbit/s



4 800 bit/s



250 kbit/s



9 600 bit/s



500 kbit/s



19.2 kbit/s



1.0 Mbit/s



38.4 kbit/s



1.5 Mbit/s

S1 DIP-switch



9 bits data format



11 bits data format



10 bits data format



12 bits data format

S2 DIP-switch



Multidrop-end unit
(Use channel 1 for end unit)



Set status interface at local fibre
link error*



Multidrop unit

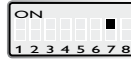

Synchronous mode
(see table on next page)



Redundant ring

* SW 2:6 ON: The status relay only change status in the unit that is connected to the receive side.

S3 DIP-switch



No termination and fail-safe



Termination with fail-safe (2-wire)



Termination with fail-safe (4-wire)

Factory settings













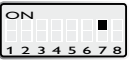











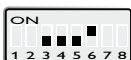

Supervision table when selecting data format

Start bit	☒	☒	☒	☒	☒	☒	☒	☒
7 bit	☒	☒	☒		☒			
8 bit				☒		☒	☒	☒
Parity			☒		☒		☒	☒
1 stop bit	☒		☒	☒			☒	
2 stop bit		☒			☒	☒		☒
Number of bit	9	10	10	10	11	11	11	12

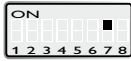
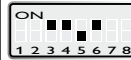
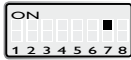
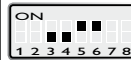
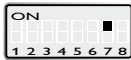
Synchronous mode ODW-632

RS-485 transmitter on-time after last data transition

SW:1	SW:2	Transmitter ON
		1.6 ms
		416 μs
		208 μs
		104 μs
		52 μs
		26 μs
		13 μs
		8.6 μs
		4.3 μs
		4 μs

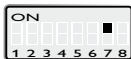
SW:1	SW:2	Transmitter ON
		2.6 μs
		2.1 μs
		2 μs
		1 μs
		500 ns
		300 ns

Example:

The data speed in a particular application is 250 kbit/s.

Calculate the maximum data transition time:
 $1/250 \times 10^3 = 4 \times 10^{-3} = 4 \mu\text{s}$.

Using dip-switches 1:3 – 1:6, set the transmitter on time to the closest higher value, e.i. 4.3 μs.

Note: Selecting a transmitter on time that is shorter than the data transition time will result in corrupted data.

RS-485 termination at system level

The system should be installed in according to the RS-485 specification. A system should always form a bus structure where the termination is at the end points of the bus. See diagrams for details of how this is done with RS-485 2-wire and 4-wire.

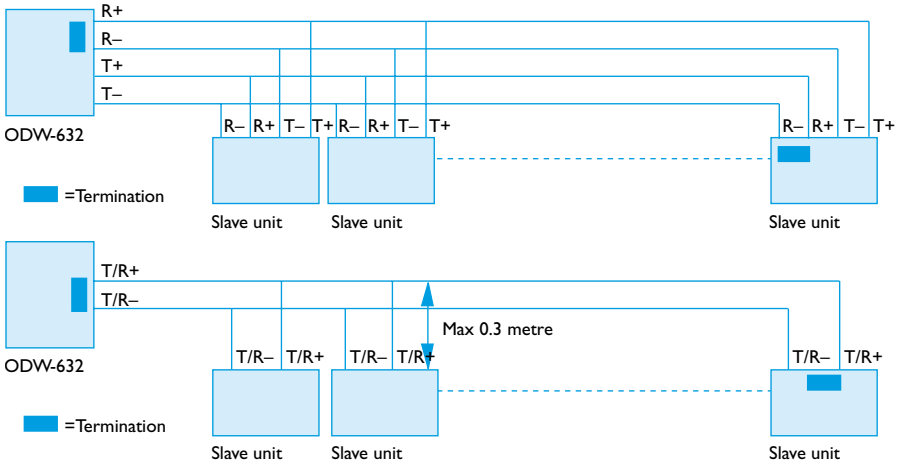

Mounting

This unit should be mounted on 35 mm DIN-rail, which is horizontally mounted inside an apparatus cabinet, or similar. Snap on mounting, see figure.

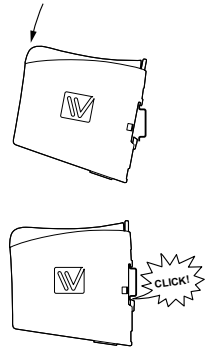

Cooling

This unit uses convection cooling. To avoid obstructing the air-flow around the unit, use the following spacing rules. Minimum spacing 25 mm (1.0 inch) above /below and 10 mm (0.4 inches) left /right the unit. Spacing is recommended for the use of unit in full operating temperature range and service life.

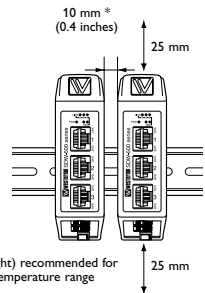

Removal

Press down the black support at the top of the unit. See figure.

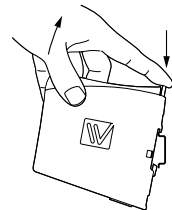

Start up guide, redundant ring application

Follow the steps below to get the unit up and running in a simple application.

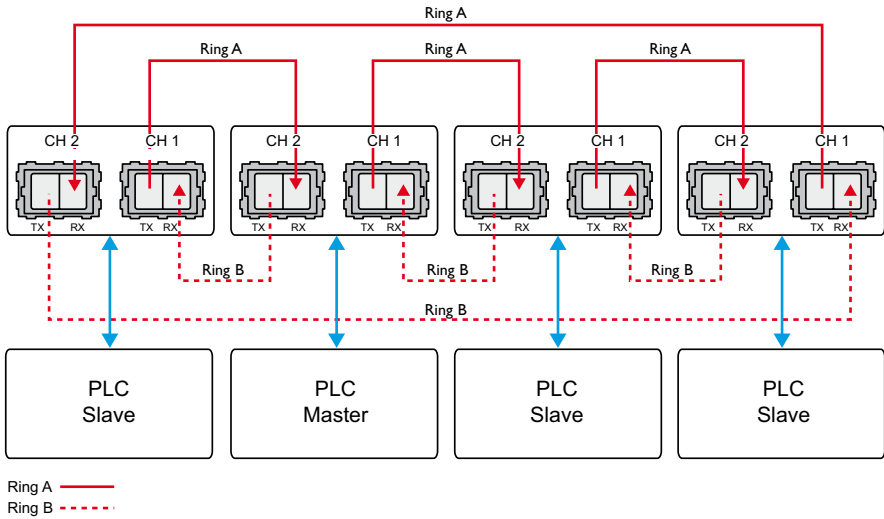

Prepare the master units

- ⌘ Configure network, with master and slaves. Check that it is running correctly with the electrical serial network.
Prepare the fibre optical network.
- ⌘ Redundant ring. Set switch S2:1 and 3 to ON and all others to OFF, at all units.
(If the status interface should be local, set S2:6 to ON)
- ⌘ Set present data rate with S1
- ⌘ Connect the fibre links between the units.
- ⌘ Connect the power supply to all units.
 - The Fibre links should be in operation, indicated by active CH 1 and CH 2 LED's.
- ⌘ Connect each of the slaves to the port of corresponding ODW-632.
- ⌘ Connect the master to the port of one ODW-632.
- ⌘ The Redundant ring application is up and running.

Multidrop application

Follow the steps below to get the unit up and running in a simple application.

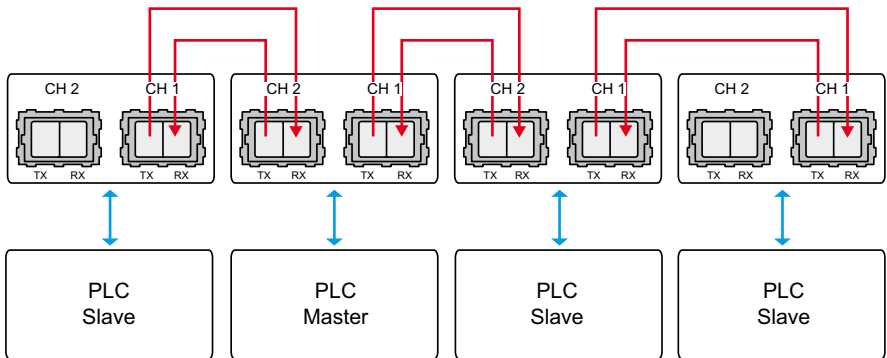

Prepare the units

- ⌘ Configure the network, with master and slaves. Check that it is running correctly with the electrical serial network.
Prepare the fibre optical network
- ⌘ Multidrop, mid units (CH 1 & CH 2). Set switch S2:1 and 2 to ON.
- ⌘ Multidrop, end units (CH 1 only). All switches should be set to OFF if it is protocol independent and Switch S2: 1 to ON if it is protocol dependent.
- ⌘ Connect the fibre links between the units.
- ⌘ Connect the power supply to all units.
 - The Fibre links should be in operation, indicated by active CH 1 and CH 2 LED's.
- ⌘ Connect each of the slaves to the serial port of the corresponding ODW-632.
- ⌘ Connect the master to the port of one ODW-632
- ⌘ The Multidrop application is up and running.

Note! ODW-621 or ODW-631 can be used as end units.

Start up guide

Note: With Bi-di fibre it is necessary to have one 1310 nm in one end and 1550 nm in the other end.

- Bi-di 1310 nm will transmit with 1310 nm and receive with 1550 nm.
- Bi-di 1550 nm will transmit with 1550 nm and receive with 1310 nm.

Redundant ring with Bi-di transceivers

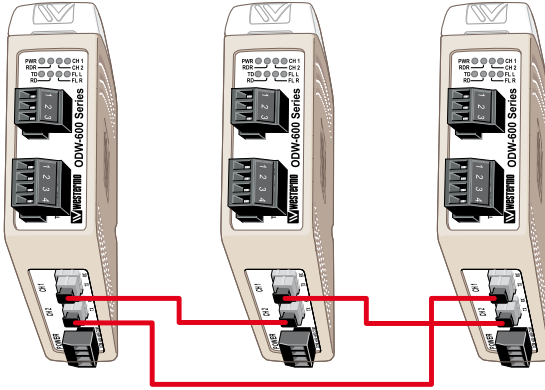

	Unit 1	Unit 2	Unit 3
CH2	Bi-di 1550 nm	Bi-di 1550 nm	Bi-di 1550 nm
CH1	Bi-di 1310 nm	Bi-di 1310 nm	Bi-di 1310 nm

Point-to-point with Bi-di transceivers

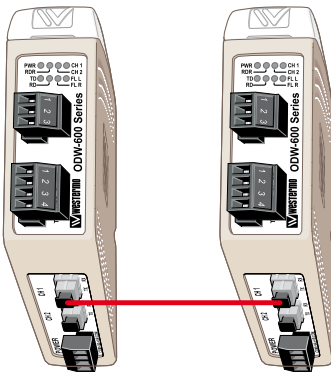

	Unit 1	Unit 2
CH1	Bi-di 1310 nm	Bi-di 1550 nm

Multidrop with Bi-di transceivers

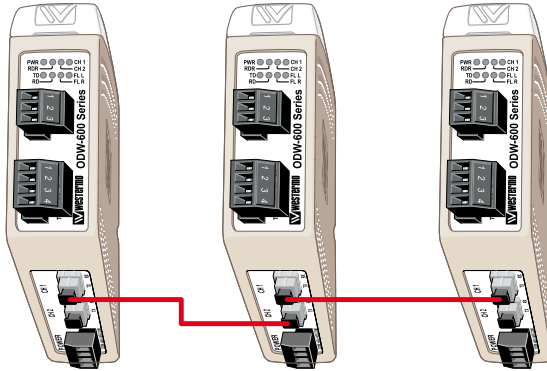

	End unit 1	Unit 2	End unit 3
CH2	–	Bi-di 1550 nm	–
CH1	Bi-di 1310 nm	Bi-di 1310 nm	Bi-di 1550 nm

Hints

If the distance is too long, it may be necessary to adjust the timing of the sender of the frame to allow acknowledgement of the received frame, during configuration of the PLC master.

Ensure that the correct protocol dependent configuration has been selected. Flashing of the TD LED indicates that a start-bit has been identified.

The definition of positive and negative T/R+, T/R– and R+, R– can differ between this ODW-631 and other units so it can be helpful to reverse the connection of + and –.



Westermo Teleindustri AB • SE-640 40 Stora Sundby, Sweden

Phone +46 16 42 80 00 Fax +46 16 42 80 01

E-mail: info@westermo.se

Westermo Web site: www.westermo.com

Subsidiaries

Westermo Data Communications AB

Svalgängen 1

SE-724 81 Västerås

Phone: +46 (0)16 42 80 00 • Fax: +46 (0)21 35 18 50

E-mail: info.sverige@westermo.se

Westermo OnTime AS

Glagsvei 20 0489 Oslo, Norway

Phone +47 22 09 03 03 • Fax +47 22 09 03 10

E-mail: contact@ontimenet.com

Westermo Data Communications Ltd

Talisman Business Centre • Duncan Road

Park Gate, Southampton • SO31 7GA

Phone: +44(0)1489 580-585 • Fax: +44(0)1489 580586

E-Mail: sales@westermo.co.uk

Westermo Data Communications GmbH

Goethestraße 67, 68753 Waghäusel

Tel.: +49(0)7254-95400-0 • Fax: +49(0)7254-95400-9

E-Mail: info@westermo.de

Westermo Data Communications S.A.R.L.

9 Chemin de Chilly 91160 CHAMPLAN

Tél : +33 1 69 10 21 00 • Fax : +33 1 69 10 21 01

E-mail : infos@westermo.fr

Westermo Data Communications Pte Ltd

2 Soon Wing Road #08-05

Soon Wing Industrial Building

Singapore 347893

Phone +65 6743 9801 • Fax +65 6745 0670

E-mail: earnestphua@westermo.com.sg

Westermo Teleindustri AB have distributors in several countries, contact us for further information.