

**EYL 225: nova225, Compact automation station**

The **nova225** compact automation station can be connected with various outlying units, so-called field modules. In conjunction with the required number of field modules, it forms a unit, as necessary for monitoring, optimising, regulating and controlling HVAC technical systems. It has a total of 86 inputs and 28 outputs. The short cycle time enables it to perform even very fast control tasks. It has communication capability and can be networked without any further provisions having to be made. The unit is programmed (parameterised) using a PC with EY3600 CASE software and the FBD Editor in accordance with IEC 1131-3.

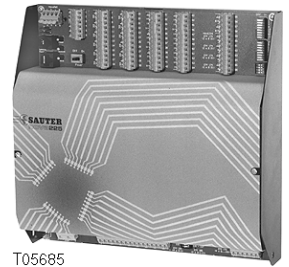

T05685

Type	Description	Power supply	Weight kg (lb)
<b>EYL 225 F001</b>	Compact automation station with field modules	230 V~	3 (6,6)
<b>EYL 225 F005</b>	Automation station, UL-certified	24 V~	3 (6,6)

**Technical details**

Power supply:-		Permissible ambient temp.:	
EYL 225 F001	230 V~, 50/60 Hz	Normal operation	0...45 °C (32...113°F)
EYL 225 F005	24 V~, 50/60 Hz	Transport and storage	-25...70 °C (-13...158°F)
Power consumption	34 VA	Permissible conditions:	
Power loss, max.	approx. 34 W	Humidity	10...90 %rh without condensation
<b>Features</b>		Degree of protection	IP 00 (EN 60529)
Analog. inputs	12x Ni/Pt1000 8x U/I/R	Protection class	I (EN 60730-1)
Field modules:-		Ambient class	IEC 60721 3K3
Digital inputs	4 channels	Wiring diagram	<a href="#">A04745</a>
4x <b>novaLink174</b>	64 (8x 8)	Dimensions: W x H x D	280 x 266 x 78 (mm) 11" x 10,5" x 3" (inch)
Digital outputs	4 channels	Dimension drawing	<a href="#">M04744</a>
4x <b>novaLink164</b>	16x 0-I	Fitting instructions	MV 505391
or (combinable)	8 channels	Factory setting	All switches at 'Off'
8x <b>novaLink165</b>	16x 0-I-II	Complies with:-	
Analog outputs	3 channels	Directive 2006/95/E	EN 60730
3x <b>novaLink170</b>	12x 0...10 V	EMC directive 2004/108/EC	EN 61000-6-1/ EN 61000-6-2 EN 61000-6-3/ EN 61000-6-4
Counters	2	Agency USA/Canada	UL Listed: UL 916 CSA certified: CSA C22.2
<b>Interfaces &amp; communication</b>			
AS network/ <b>novaNet</b>	2x a/b terminals 1x RJ-11 socket (6/6)		
Control panel <b>nova240</b>			
EYT 240 F001	1x RJ-45 socket		
<b>nova240</b> language:			
German, French, English, Italian, Dutch, Spanish, Swedish, Norwegian, Danish, Portuguese, Finnish (for other languages, see <i>Accessories</i> )			

**Accessories**

<b>EYT 240</b>	Control panel <b>nova240</b>
<b>0501113 002</b>	<b>nova215</b> and <b>nova225</b> microprograms with <b>nova240</b> language: German, French, English, Polish, Slovenian, Hungarian, Romanian, Russian, Czech, Turkish, Slovakian
<b>0367842 002</b>	Connecting cable: <b>nova</b> AS to <b>nova240</b> , 1,5 m (4,9 ft)
<b>0367842 003</b>	Connecting cable: <b>nova</b> AS to <b>nova240</b> , 2,9 m (9,5 ft)
<b>0367842 004</b>	Connecting cable: <b>nova</b> AS to <b>nova240</b> , 6,0 m (19,7 ft)
<b>0367862 001</b>	<b>novaNet</b> connecting cable: <b>novaNet 290/291</b> to AS, 1,50 m (4 9 ft)
<b>0367862 002</b>	<b>novaNet</b> connecting cable: <b>novaNet 290/291</b> to AS, 2,90 m (9 5 ft)
<b>0367862 003</b>	<b>novaNet</b> connecting cable: <b>novaNet 290/291</b> to AS, 6,0 m (19,7 ft)
<b>0367883 002</b>	5x EPROM (empty; USER-EPROM)
<b>0367888 001</b>	5x EPROM (4 Mbit; empty)

### Engineering notes

Using two top-hat rails (EN 50022), the **nova225** automation station can be fitted in a panel.

The EYL 225 F001 station requires a power supply of 230 V~ and the EYL 225 F005 requires 24 V~ (USA: power source class 2).

The earthing terminals are connected to ground (PE) and to the housing.

The plant devices are connected via spring-type terminals. The following conditions must be observed:-

Cable size:	min. 0,8 mm <sup>2</sup> (AWG 18), max. 2,5 mm <sup>2</sup> (AWG 13), adhering to the norms
Analog inputs:	< 10 V =
Analog outputs:	no extraneous voltage
Counters:	potential-free contacts, opto-coupler, transistor (open collector)
<b>novaLink:</b>	100 m max. (5 nF/7,5 Ω) twisted and shielded, both ends to earth.
<b>novaNet:</b>	with twisted cable

The **nova225** automation station has a fast operating program which reads in all inputs every processes the parameterised modules, updates the outputs and carries out the communication with other stations or visualisation PCs.

The station is programmed (the so-called *user data*) via the **nova-Net** automation network. The data are stored in a battery-backed memory. The battery's serviceable life is at least ten years.

The data can be saved permanently by means of the USER-EPROM.

Every station needs an AS address; this is set via coding switches.

### Inputs and outputs

#### Temperature measurement

Number of inputs	12
Type of inputs	Ni1000 (without coding) Pt1000 (software coding)
Measuring ranges:	
Ni1000	-50...+150 °C (-58...+302°F)
Pt1000	-100...+500 °C (-148...+932°F)

The Ni/Pt inputs, which do not need calibrating, already take the resistance of the cable into account and can be used for Ni1000 and Pt1000.

Linear-correction factors <i>a</i> and <i>b</i> :	( $Y = a X + b$ )
Slope <i>a</i>	No entry is needed here. A proportional factor, which gives the result in °C, can be called up direct from the microprogram.
Zero-point shift <i>b</i>	No calibration is needed here. A line resistance of 2 Ω is included and has been compensated for. If the line resistance R is greater (deviation > 2 Ω):- $b = -0,18 \times (R - 2 \Omega)$ in room-temperature range or $b = -0,16 \times (R - 2 \Omega)$ at approx. 100 °C

The sensors are connected using the two-wire method; the connecting leads can be up to 55 m (AWG 18 max. 180 ft) long if 0,8 mm<sup>2</sup>, or 170 m (AWG 15 max. 558 ft) if 1,5 mm<sup>2</sup>. The measuring voltage is pulsed in order to prevent the sensor from warming up.

While the inputs are intended for Ni1000 sensors, they can also be used with Pt1000 sensors. The linearisation guarantees error of a mere 0,06 °C.

The measuring method is chosen via the software.

The Ni1000 measuring value is strictly linear and is better than ±0,06 °C (± 0,1°F) from -50 °C to +150 °C.

The linearisation for Pt1000 guarantees negligible error between -50 and +100 °C (-58...212°F).

For the full measuring range of the Pt1000, the following table applies:-

Temperature		Absolute difference	
-100 °C	(-148°F)	-0,05 °C	(-0,09°F)
-50 °C to +100 °C	(-58...212°F)	< ± 0,02 °C	(± 0,04°F)
+150 °C	(302°F)	+0,05 °C	(+0,09°F)
200 °C	(392°F)	+0,11 °C	(+0,2°F)
300 °C	(572°F)	+0,29 °C	(+0,52°F)
400 °C	(752°F)	+0,10 °C	(+0,18°F)
500 °C	(932°F)	-0,31 °C	(-0,56°F)

**Measurement of U/I/R**

Number of Inputs	8
Type of inputs	Voltage 0 (2)...10 V, 0 (0,2)...1 V Current 0 (4)...20 mA Potentiometer 500 Ω...2 kΩ

Linear-correction factors  $a$  and  $b$ :  $(Y = a X + b)$   
The linearity can be adapted very accurately for every input.

**Settings for a standardised signal (0...1)**

Linear-correction factors		Inputs
a	b	
1	0	0...10 V
10	0	0...1 V
1	0	0...20 mA
20	0	0...1 mA
1,25	-0,25	2...10 V
1,25	-0,25	4...20 mA
12,5	-0,25	0,2...1 V

Input limit values:

Measurement of voltage	$< \pm 50$ V
Measurement of current	$< 50$ mA
Loading of reference outputs	$< 10$ mA
Return line for all signals:	earth
Accuracy:	$U = \pm 0,1\%$ ( $\pm 0,01$ V) $I = \pm 0,1\%$ ( $\pm 0,02$ mA) $R = \pm 0,5\%$ ( $\pm 0,05$ V)
Resolution:	$U = 5$ mV

**Measuring the voltage (U)**

The voltage is measured between one of the input terminals for voltage (marked with a 'U') and an earth terminal. The signal must be potential-free. The two measurements 0 (0,2)...1 V and 0 (2)...10 V are selected via the software.

The maximum voltage without damage being incurred is  $< \pm 50$  V. The visible range, however, is limited to 10 V. The internal resistance  $R_i$  of the input (load) is 60 kΩ in this case.

**Measuring the current (I)**

There are special terminals (marked with an 'I') available for measuring the current. The current signal must also be potential-free. The maximum input current must be limited to 50 mA. The internal resistance  $R_i$  is 100 Ω.

**Measuring the resistance (R)**

The potentiometer is connected to terminals U, earth and +1 V. The +1 V reference voltage is pulsed. If all eight measuring inputs are used, the reference outputs must be doubly occupied. In order not to overload the reference outputs, the lowest potentiometer value should not be less than 500 Ω, even through parallel switching in the event of double occupation. The reference output is protected against short circuits, but can destroy the potentiometer by the short-circuit current. The potentiometer's upper value of 2 kΩ is prescribed in order to guarantee stable measurements free of interference.

**Pulse metering**

Number of inputs	2
Type of inputs	potential-free contacts opto-coupler transistor (open collector)
Input frequency	$< 15$ Hz
Max. output current of the inputs	1,2 mA with respect to earth
De-bounce time	20 ms
Max. permissible input resistance	1 kΩ (including cable)
Protected against extraneous voltage	up to 24 V ac/dc

Potential-free contacts, opto-couplers or transistors with open collectors can be connected to the meter inputs. The maximum pulse frequency is 15 Hz.

A de-bounce time of 20 ms is envisaged so that the switching contacts are correctly received. The pulse is received on the falling flank and can remain present indefinitely. The automation station's internal counter value is interrogated every cycle and stored in DW 2 as a dual partial sum. The summation to form the counter value is done by the software after 30s at the latest via the station's processor in DW 6. Through using the FP format, the counter value can be a maximum of  $2,147 \times 10^9$ .

With the FP format, it is possible to show counter values up to 67,108,864 with a resolution of 1.

Any counter overflow can be curbed by resetting using the 'C\_Preset' function module.

#### Digital inputs

with 4× **novaLink174** 4× 16 inputs

The **nova225** AS processes 64 items of digital information. The monitored inputs are connected via **novaLink** to the AS.

#### Digital outputs

with 4× **novaLink164** 4 channels à 4× 0-I

with 8× **novaLink165** 8 channels à 2× 0-I-II

The optical indicator for the (exclusively pseudo) feedback signal is situated on the **novaLink164/novaLink165** field module. The switches for manual operations and the DIL switches for pre-setting the priority levels can also be found there.

#### Analog outputs

with 3× **novaLink170** 3 channels à 4× 0...10 V, 20 mA max. or 2× 0...10 V and 2× 0...20 mA.

The **nova225** allows 12 analog positioning values to be issued. The **novaLink170** field module has manual operating elements, with which the user can manually set the analog values and carry out the pre-setting of the priority values.

The **nova225** automation station has no indicator elements apart from the operating indicators. The status of all digital inputs and outputs is shown on the field modules. There is a control panel (the EYT 240 F001) available.

The operations indicator on the **nova225** (EYL 225 F001) has three LEDs: the **green LED** (at the top) when on continuously indicates that there is a power supply, while the **two yellow LEDs** are for telegram traffic in both directions on the **novaNet** line. In stand-alone mode (without **novaNet**), the *Receive* LED remains unlit, and the *Send* LED flashes rapidly.

The **nova240** control panel (manual operating unit) can be connected via the RJ-45 socket.

The **nova225** automation station has an operating program which reads in all inputs, processes the parameterised modules, updates the outputs and carries out communication with other stations or visualisation PCs.

A real-time clock for the time programmes is also integrated in the automation stations.

A lithium battery ensures that the user data (FBD data), time programmes and historical data (HDB) are retained in the SRAM in the event of a power failure. The real-time clock also runs off this lithium battery.

The battery makes it possible to retain the data and run the real-time clock for at least 10 years without power having to be applied.

Date and time are set ex works.

When power is restored, the automation station checks the consistency of the data and starts communication.

The user programmes can be loaded from any point in the novaNet. The data stay in the battery-backed SRAM even in the event of a power failure. In addition, the data can be stored captive in a user EPROM. Therefore, the level of protection against loss of data is very high.

Every station needs an AS address (0...28671), which is set via coding switches.

### Putting into operation

When connecting the power supply, the earthing lead must be connected to the screw terminal provided (protection class I).

When working with these units, the power supply must be disconnected.

The appropriate field modules can be connected via terminals 59 to 66 and 102 to 117. The **novaLink** channels of the digital outputs must be encoded in accordance with the relevant unit (**novaLink164** or **novaLink165**) as shown below.

Off	Off	On
103		103-105
107		107-109
111		111-113
115		115-117

EYY 164 (4 x 0-1)      S5      EYY 165 (2 x 0-I-II) B04742a

		S5-1			
		Off		On	
novaLink channel	Terminals		MFA		MFA
1	102/103	novaLink164	32, 33 34, 35	novaLink165	32, 33
2	104/105			novaLink165	34, 35
		S5-2			
		Off		On	
novaLink channel	Terminals		MFA		MFA
3	106/107	novaLink164	36, 37 38, 39	novaLink165	36, 37
4	108/109			novaLink165	38, 39
		S5-3			
		Off		On	
novaLink channel	Terminals		MFA		MFA
5	110/111	novaLink164	40, 41 42, 43	novaLink165	40, 41
6	112/113			novaLink165	42, 43
		S5-4			
		Off		On	
novaLink channel	Terminals		MFA		MFA
7	114/115	novaLink164	44, 45 46, 47	novaLink165	44, 45
8	116/117			novaLink165	46, 47

Before being linked to the **novaNet**, each **AS** must be given a clear (unique) address. This station number is binary-encoded via the block of DIL switches.

The following example is intended as an explanation of the binary encoding: AS number 10255.

Off	On	Value	Off	On	
<input type="checkbox"/>	<input checked="" type="checkbox"/>	1		x	1
<input type="checkbox"/>	<input checked="" type="checkbox"/>	2		x	2
<input type="checkbox"/>	<input checked="" type="checkbox"/>	4		x	4
<input type="checkbox"/>	<input checked="" type="checkbox"/>	8		x	8
<input checked="" type="checkbox"/>	<input type="checkbox"/>	16	x		
<input checked="" type="checkbox"/>	<input type="checkbox"/>	32	x		
<input checked="" type="checkbox"/>	<input type="checkbox"/>	64	x		
<input checked="" type="checkbox"/>	<input type="checkbox"/>	128	x		
<input type="checkbox"/>	<input type="checkbox"/>	256		x	
<input type="checkbox"/>	<input type="checkbox"/>	512		x	
<input type="checkbox"/>	<input type="checkbox"/>	1024		x	
<input type="checkbox"/>	<input checked="" type="checkbox"/>	2048		x	2048
<input checked="" type="checkbox"/>	<input type="checkbox"/>	4096	x		
<input type="checkbox"/>	<input checked="" type="checkbox"/>	8192		x	8192
<input checked="" type="checkbox"/>	<input type="checkbox"/>	16384	x		
<input checked="" type="checkbox"/>	<input type="checkbox"/>	Even	x		
<input type="checkbox"/>	<input type="checkbox"/>	Parity			

B04723

The AS address, which is set by means of the 16 DIL switches, is given a binary code anywhere between 0 and 28671 (for the AS). The last switch is for setting the parity, which refers to the station number and not to the four other switches (Reset, B, C and D) situated below. The parity should be set so that the number of switches in the 'on' position, including parity, is even.

If the station has not already got an EPROM with the parameterised user data, they must be transmitted to the station. The transfer is performed via the **novaNet** bus by the corresponding terminals or by the RJ-11 connector. Programming can be done in parallel to the data traffic, though this may lengthen the response time of the other network subscribers. For this reason, the station can be separated from the **novaNet** for the duration of the data transfer and the 'parameterising' PC can be connected locally. After the data transfer has been completed, the data are immediately active. The station can then be re-connected to the network and is ready for operation.

You are strongly advised to save the user data in an EPROM as well. Apart from enhancing data security, it facilitates fault-finding. The EPROM can be loaded with any normal programming device and employed in the station.

**nova225**

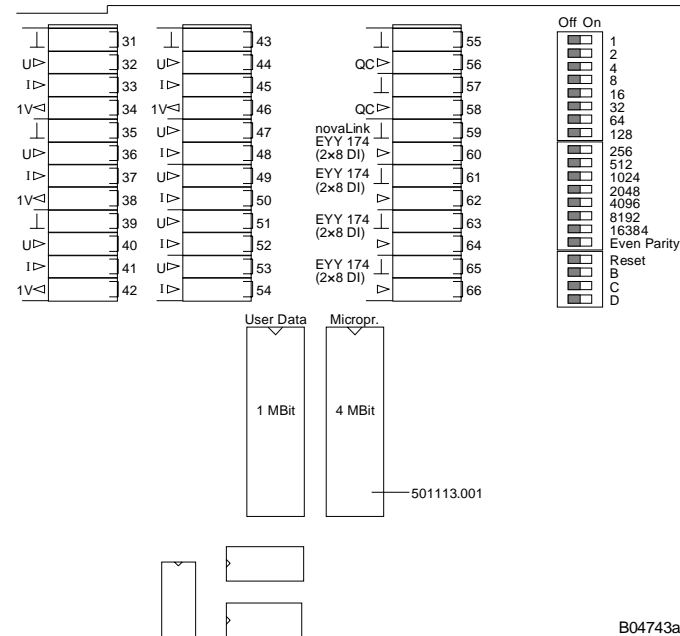

B04743a

Before opening, the station, disconnect the power supply! Protective measures to prevent electrostatic discharges must be taken before performing any work on the unit. Afterwards, the station must be reset by means of the reset switch.

Reset:

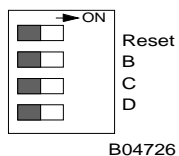

B04726

The reset switch should be set to 'ON' for approx. ½ s, causing the station to load the user data from the EPROM and to start operation under defined conditions.

If the reset switch is left in the ON position, the station remains in the reset mode and cannot function correctly.

### Relationship between MFAs and terminals

nova225 connection	MFA	Code	Terminals			
Ni1000/Pt1000			<b>GND</b>	<b>Input</b>		
	00	51	7	8		
	01	51	9	10		
	02	51	11	12		
	03	51	13	14		
	04	51	15	16		
	05	51	17	18		
	06	51	19	20		
	07	51	21	22		
	08	51	23	24		
	09	51	25	26		
	10	51	27	28		
	11	51	29	30		
<b>Analog input</b>			<b>GND</b>	<b>U/R</b>	<b>I</b>	<b>+1 V Ref.</b>
U//R	12	50	31	32	33	34
U//R	13	50	35	36	37	38
U//R	14	50	39	40	41	42
U//R	15	50	43	44	45	46
U//R	16	60	(31)	47	48	
U//R	17	60	(35)	49	50	
U//R	18	60	(39)	51	52	
U//R	19	60	(43)	53	54	
<b>Analog output</b>			<b>GND</b>	<b>novaLink170</b>		
0-10 V	20	91				
0-10 V	21	91	118	119		
0-10 V or 0-20 mA	22	91				
0-10 V or 0-20 mA	23	91				
0-10 V	24	91				
0-10 V	25	91	120	121		
0-10 V or 0-20 mA	26	91				
0-10 V or 0-20 mA	27	91				
0-10 V	28	91				
0-10 V	29	91	122	123		
0-10 V or 0-20 mA	30	91				
0-10 V or 0-20 mA	31	91				

nova225 connection	MFA	Code	Terminals			
			GND	novaLink164	GND	novaLink165
0-I / 0-I-II	32	30	102	103	102	103
0-I / 0-I-II	33	30			104	105
0-I / 0-I-II	34	30				
0-I / 0-I-II	35	30				
0-I / 0-I-II	36	30	106	107	106	107
0-I / 0-I-II	37	30			108	109
0-I / 0-I-II	38	30				
0-I / 0-I-II	39	30				
0-I / 0-I-II	40	30	110	111	110	111
0-I / 0-I-II	41	30			112	113
0-I / 0-I-II	42	30				
0-I / 0-I-II	43	30				
0-I / 0-I-II	44	30	114	115	114	115
0-I / 0-I-II	45	30			116	117
0-I / 0-I-II	46	30				
0-I / 0-I-II	47	30				
<b>Pulse counter</b>			<b>GND</b>	<b>Input</b>		
	50	C1	55		56	
	51	C1	57		58	
<b>Digital input</b>			<b>GND</b>	<b>novaLink174</b>		
	52-1...8	10	59		60	
	53-1...8	10				
	54-1...8	10	61		62	
	55-1...8	10				
	56-1...8	10	63		64	
	57-1...8	10				
	58-1...8	10	65		66	
	59-1...8	10				

**Dimension drawing**

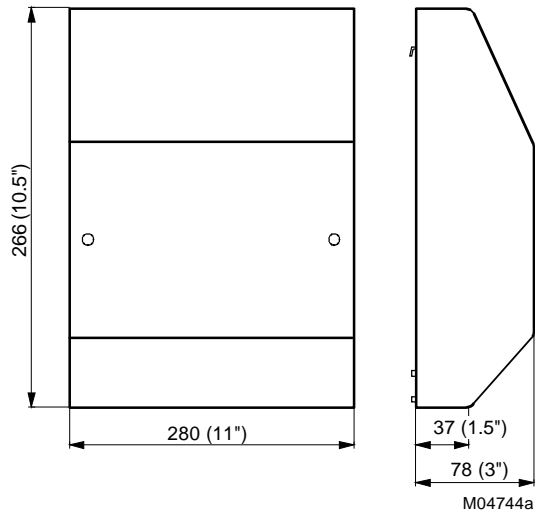

**Fitting to top-hat rail**

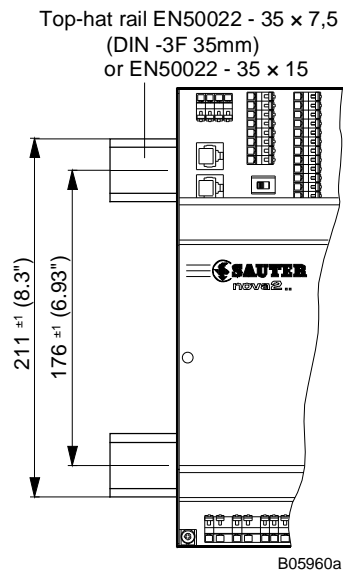



Wiring diagram

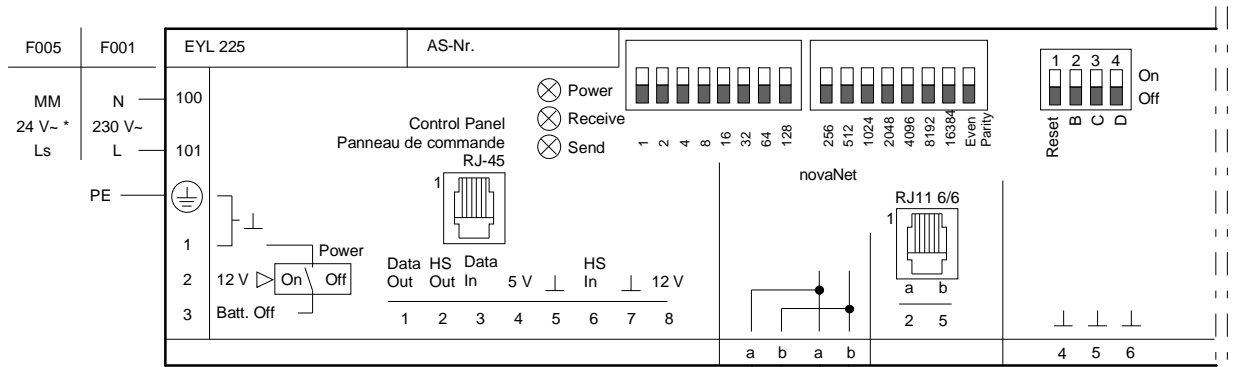

\* USA: power source class 2

Dans les cas où la conformité avec la norme industrielle (EN 61000-6-2) est impérative, les câbles d'alimentation pour les entrées/sorties analogiques (AI/AO) ainsi que le câble d'alimentation de novaLink ne devront pas dépasser une longueur de 30 m.

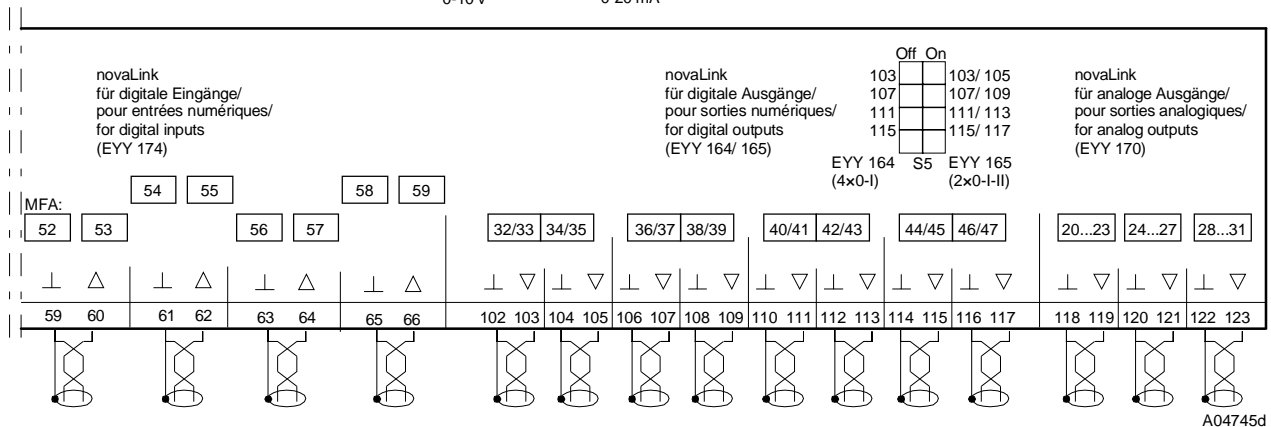
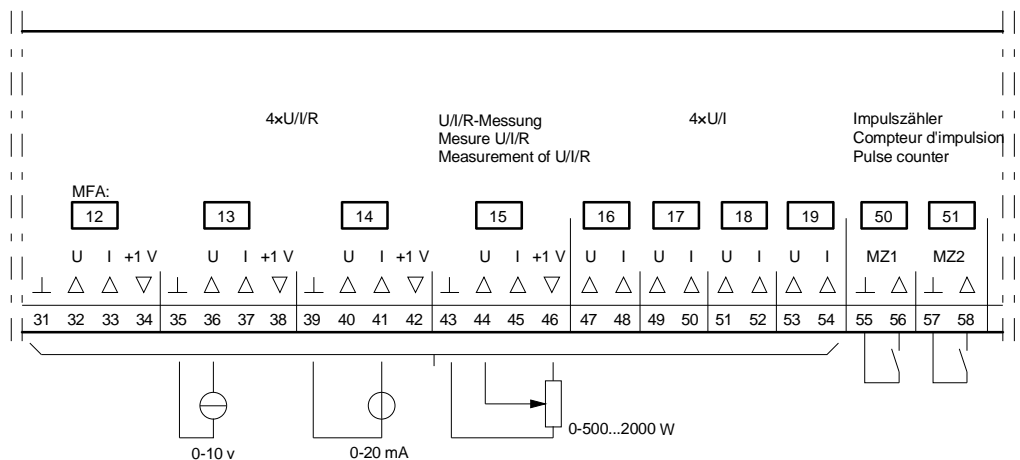
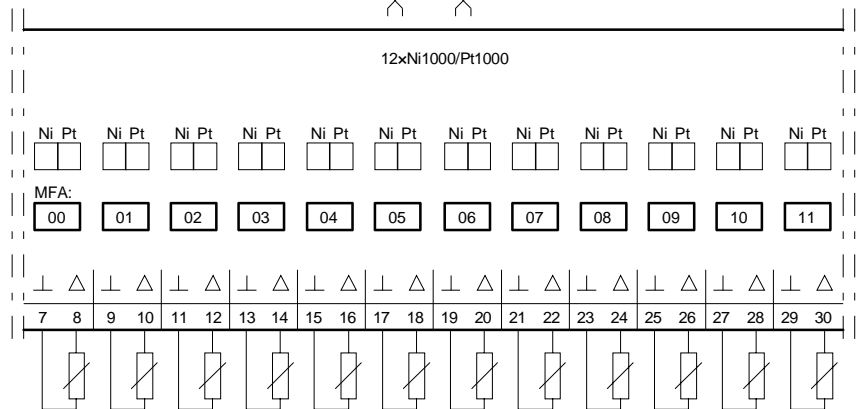

A04745d

Printed in Switzerland  
 Right of amendment reserved  
 N.B.: A comma between cardinal numbers denotes a decimal point  
 © Fr. Sauter AG, CH-4016 Basle  
 7192525003 03